

1.48 μ m LD Module AF4B SERIES type C output power 300mW ~ 400mW

The AF4B SERIES type C is 1.48 μ m high power laser diode modules designed for Er doped fiber amplifier. The laser is packaged in a 14-pin butterfly package with optical isolator, monitor photodiode and thermo-electric cooler (TEC).

FEATURES

- ◆ Optical output :
 - 300mW ($I_F \leq 1100\text{mA}$) AF4B130CA75L / AF4B130CD75L
 - 350mW ($I_F \leq 1400\text{mA}$) AF4B135CA75L / AF4B135CD75L
 - 400mW ($I_F \leq 1400\text{mA}$) AF4B140CA75L / AF4B140CD75L
- ◆ Fiber
 - SMF output (UV coating fiber: $\phi 0.25\text{mm}$)
 - PMF output (UV coating fiber: $\phi 0.25\text{mm}$)
- ◆ 14pin butterfly package
- ◆ Built-in optical isolator
- ◆ Internal monitor PD and TEC
- ◆ Low power consumption

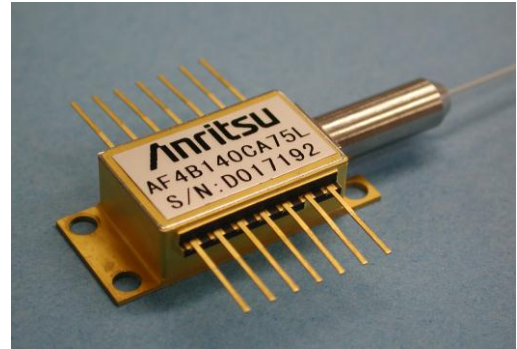

DIMENSIONS

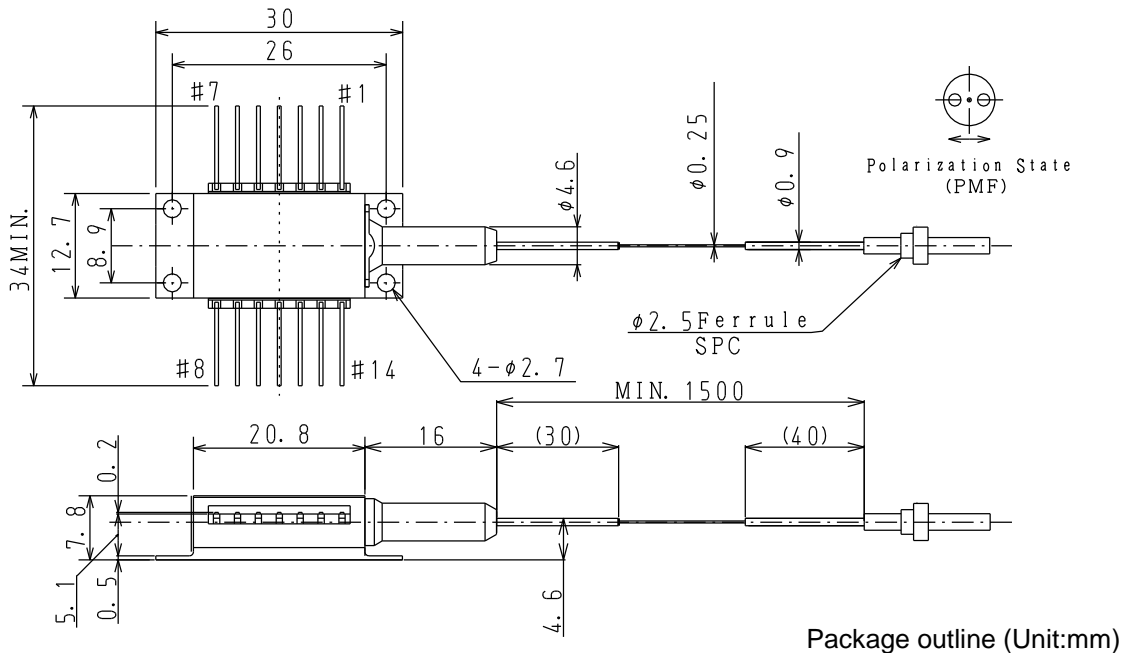

(Note) Polarization state of LD is aligned parallel to the slow axis.

■ ABSOLUTE MAXIMUM RATINGS

Item	Symbol	Rating			unit
		AF4B130CA75L AF4B130CD75L	AF4B135CA75L AF4B135CD75L	AF4B140CA75L AF4B140CD75L	
LD Forward Current	IF	1500	1700		mA
LD Reverse Voltage	VR	2			V
PD Forward Current	IFD	10			mA
PD Reverse Voltage	VRD	20			V
Operating Case temperature	Tc	-20~+70			°C
Storage temperature	Tstg	-40~+85			°C
Cooler Current	Ic	5.8			A

* Excess over the absolute maximum ratings may lead to damage.

■ Top View

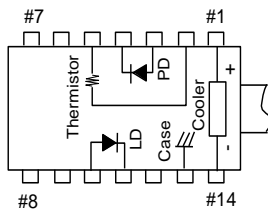

■ Pin Configuration

No.	FUNCTION	No.	FUNCTION
1	Cooler anode	8	NC
2	Thermistor	9	NC
3	PD anode	10	LD anode
4	PD cathode	11	LD cathode
5	thermistor	12	NC
6	NC	13	Case
7	NC	14	Cooler cathode

■ OPTICAL AND ELECTRICAL CHARACTERISTICS (T_{LD}=25°C, T_C=25°C)

Item	Symbol	Test condition		AF4B130CA75L AF4B130CD75L	AF4B135CA75L AF4B135CD75L	AF4B140CA75L AF4B140CD75L	Unit
Output power	Pf			300	350	400	mW
Forward Voltage	VF	At Output Power	Max.	2			V
			Typ.	100			mA
			Max.	150			
Forward Current (BOL)	IF	At Output Power	Max.	1100	1400		mA
			Min.	1460			nm
				Typ.	1475		
Max.	1490						
Spectral width	$\Delta\lambda$	At Output Power RMS (-20dB)	Typ.	5			nm
			Max.	10			
Monitor Current	Im	At Output Power VRD=5V	Min.	100			μ A
			Typ.	-			
			Max.	2000			
PD Dark Current	Id	VRD=5V	Max.	0.1			μ A
Tracking Error	Δ Pf	Im=const, Tc=-20~70°C	Max.	0.5			dB
Cooler Voltage	Vc	IF=*EOL, Tc=70°C	Max.	2.9	3.1		V
Cooler Current	Ic	IF=*EOL, Tc=70°C	Max.	2.7	3		A
Thermistor Resistance	Rth	TLD=25°C B=3900±100K	Min.	9.5			KΩ
			Typ.	10			
			Max.	10.5			
Optical Isolation	Ro	TLD=25°C	Typ.	30			dB
Extinction Ratio ²	Xp	At Output Power	Min.	17			dB

*EOL=BOL × 1.2

² Only PMF

■ AF4B SERIES type C TYPICAL CHARACTERISTICS

- ◆ Fiber output power / Monitor Current / Voltage-Forward current characteristics / Emission spectrum

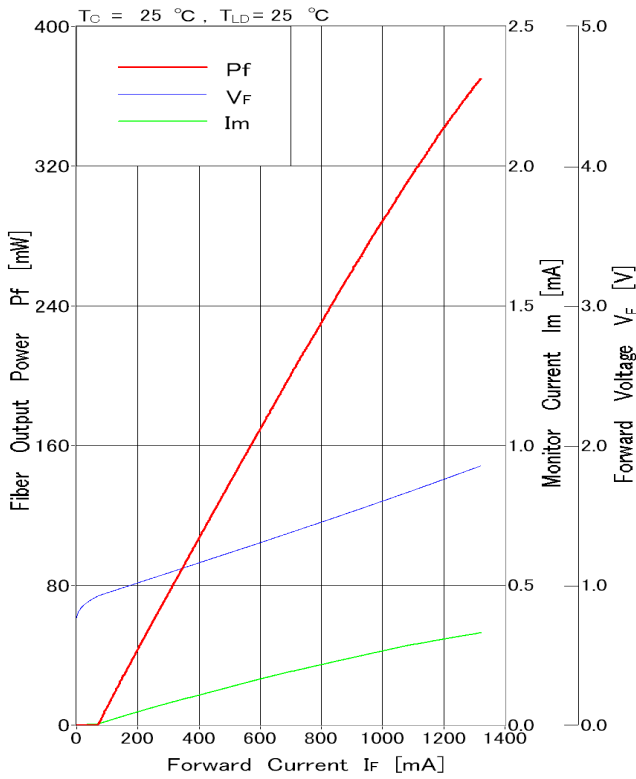

【AF4B140CA75L】

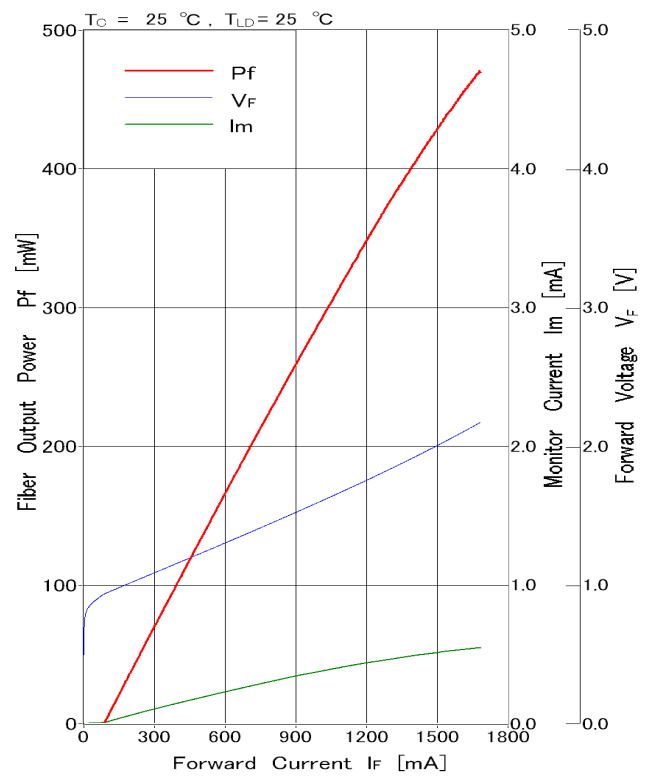

◆ EMISSION SPECTRUM

【AF4B130CA75L】

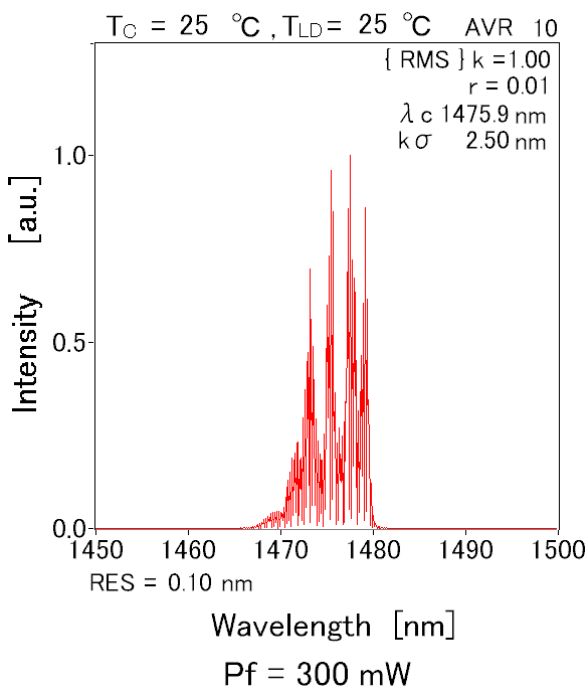

【AF4B140CA75L】

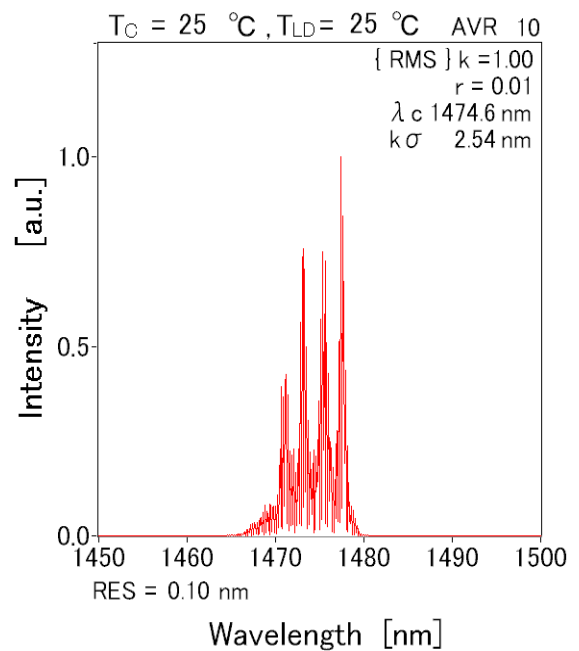

■ ORDERING INFORMATION

MODEL : A F 4 B 1 # # C # # # #

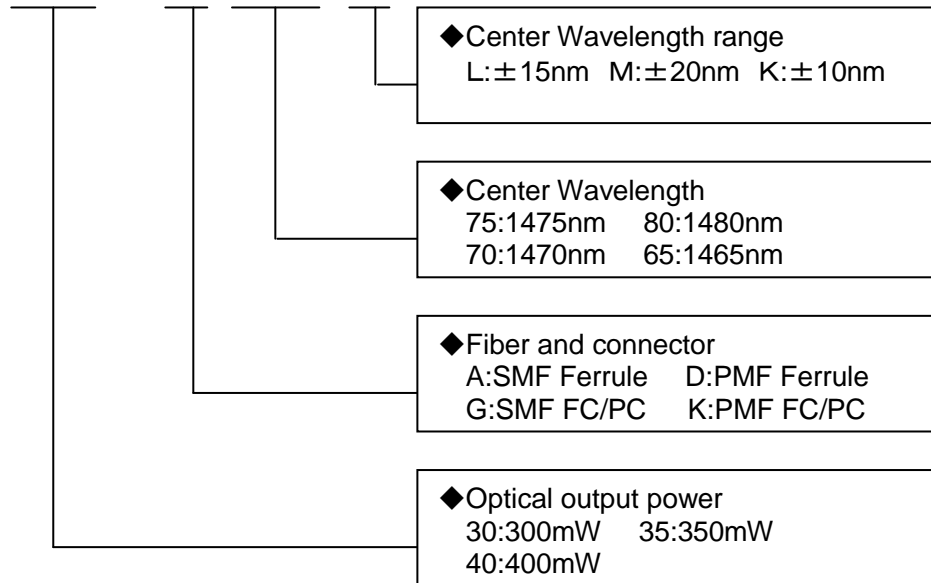

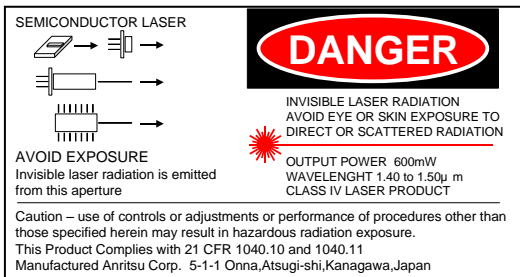

Anritsu Corporation reserves the right to change the design or specification of the product at any time without notice.

ANRITSU CORP. <http://www.anritsu.co.jp/>

Anritsu Corporation

5-1-1 Onna, Atsugi-shi, Kanagawa, 243-8555 Japan
Phone: +81-46-223-1111
Fax: +81-46-296-1238

• U.S.A.

Anritsu Company

1155 East Collins Blvd., Suite 100, Richardson,
TX 75081, U.S.A.
Toll Free: 1-800-267-4878
Phone: +1-972-644-1777
Fax: +1-972-671-1877

• Canada

Anritsu Electronics Ltd.

700 Silver Seven Road, Suite 120, Kanata,
Ontario K2V 1C3, Canada
Phone: +1-613-591-2003
Fax: +1-613-591-1006

• Brazil

Anritsu Eletrônica Ltda.

Praça Amadeu Amaral, 27 - 1 Andar
01327-010 - Bela Vista - São Paulo - SP - Brazil
Phone: +55-11-3283-2511
Fax: +55-11-3288-6940

• Mexico

Anritsu Company, S.A. de C.V.

Av. Ejército Nacional No. 579 Piso 9, Col. Granada
11520 México, D.F., México
Phone: +52-55-1101-2370
Fax: +52-55-5254-3147

• U.K.

Anritsu EMEA Ltd.

200 Capability Green, Luton, Bedfordshire, LU1 3LU, U.K.
Phone: +44-1582-433200
Fax: +44-1582-731303

• France

Anritsu S.A.

12 avenue du Québec, Bâtiment Iris 1- Silic 612,
91140 VILLEBON SUR YVETTE, France
Phone: +33-1-60-92-15-50
Fax: +33-1-64-46-10-65

• Germany

Anritsu GmbH

Nemetschek Haus, Konrad-Zuse-Platz 1
81829 München, Germany
Phone: +49-89-442308-0
Fax: +49-89-442308-55

• Italy

Anritsu S.r.l.

Via Elio Vittorini 129, 00144 Roma, Italy
Phone: +39-6-509-9711
Fax: +39-6-502-2425

• Sweden

Anritsu AB

Borgarfjordsgatan 13A, 164 40 KISTA, Sweden
Phone: +46-8-534-707-00
Fax: +46-8-534-707-30

• Finland

Anritsu AB

Teknobulevardi 3-5, FI-01530 VANTAA, Finland
Phone: +358-20-741-8100
Fax: +358-20-741-8111

• Denmark

Anritsu A/S (Service Assurance)

Anritsu AB (Test & Measurement)
Kay Fiskers Plads 9, 2300 Copenhagen S, Denmark
Phone: +45-7211-2200
Fax: +45-7211-2210

• Russia

Anritsu EMEA Ltd.

Representation Office in Russia
Tverskaya str. 16/2, bld. 1, 7th floor.
Russia, 125009, Moscow
Phone: +7-495-363-1694
Fax: +7-495-935-8962

• United Arab Emirates

Anritsu EMEA Ltd.

Dubai Liaison Office

P O Box 500413 - Dubai Internet City
Al Thuraya Building, Tower 1, Suit 701, 7th Floor
Dubai, United Arab Emirates
Phone: +971-4-3670352
Fax: +971-4-3688460

• Singapore

Anritsu Pte. Ltd.

60 Alexandra Terrace, #02-08, The Comtech (Lobby A)
Singapore 118502
Phone: +65-6282-2400
Fax: +65-6282-2533

• India

Anritsu Pte. Ltd.

India Branch Office

3rd Floor, Shri Lakshminarayan Niwas, #2726, 80 ft Road,
HAL 3rd Stage, Bangalore - 560 075, India
Phone: +91-80-4058-1300
Fax: +91-80-4058-1301

• P.R. China (Hong Kong)

Anritsu Company Ltd.

Units 4 & 5, 28th Floor, Greenfield Tower, Concordia Plaza,
No. 1 Science Museum Road, Tsim Sha Tsui East,
Kowloon, Hong Kong
Phone: +852-2301-4980
Fax: +852-2301-3545

• P.R. China (Beijing)

Anritsu Company Ltd.

Beijing Representative Office

Room 2008, Beijing Fortune Building,
No. 5, Dong-San-Huan Bei Road,
Chao-Yang District, Beijing 100004, P.R. China
Phone: +86-10-6590-9230
Fax: +86-10-6590-9235

• Korea

Anritsu Corporation, Ltd.

502, 5FL H-Square N B/D, 681
Sampyeong-dong, Bundang-gu, Seongnam-si,
Gyeonggi-do, 463-400 Korea
Phone: +82-31-696-7750
Fax: +82-31-696-7751

• Australia

Anritsu Pty. Ltd.

Unit 21/270 Ferntree Gully Road, Notting Hill,
Victoria 3168, Australia
Phone: +61-3-9558-8177
Fax: +61-3-9558-8255

• Taiwan

Anritsu Company Inc.

7F, No. 316, Sec. 1, NeiHu Rd., Taipei 114, Taiwan
Phone: +886-2-8751-1816
Fax: +886-2-8751-1817

■本製品を持ち出すときは、外国為替および外国貿易法の規定により、日本国政府の輸出許可または役務取引許可が必要となる場合がありますので、必ず弊社の営業担当までご連絡ください。