

MU120010A
T1/T3 Unit
Operation Manual

Seventh Edition

Read this manual before using the equipment.
Keep this manual with the equipment.

ANRITSU CORPORATION

Safety Symbols

To prevent the risk of personal injury or loss related to equipment malfunction, Anritsu Corporation uses the following safety symbols to indicate safety-related information. Insure that you clearly understand the meanings of the symbols BEFORE using the equipment. Some or all of the following five symbols may not be used on all Anritsu equipment. In addition, there may be other labels attached to products which are not shown in the diagrams in this manual.

Symbols used in manual

DANGER  This indicates a very dangerous procedure that could result in serious injury or death if not performed properly.

WARNING  This indicates a hazardous procedure that could result in serious injury or death if not performed properly.

CAUTION  This indicates a hazardous procedure or danger that could result in light-to-severe injury, or loss related to equipment malfunction, if proper precautions are not taken.

Safety Symbols Used on Equipment and in Manual

The following safety symbols are used inside or on the equipment near operation locations to provide information about safety items and operation precautions. Insure that you clearly understand the meanings of the symbols and take the necessary precautions BEFORE using the equipment.



This indicates a prohibited operation. The prohibited operation is indicated symbolically in or near the barred circle.



This indicates an obligatory safety precaution. The obligatory operation is indicated symbolically in or near the circle.



This indicates warning or caution. The contents are indicated symbolically in or near the triangle.



This indicates a note. The contents are described in the box.



These indicate that the marked part should be recycled.

MU120010A
T1/T3 Unit
Operation Manual

30 June 1997 (First Edition)
21 September 2004 (Seventh Edition)

Copyright © 1997-2004, ANRITSU CORPORATION.

All rights reserved. No part of this manual may be reproduced without the prior written permission of the publisher.

The contents of this manual may be changed without prior notice.

Printed in Japan

For Safety

WARNING



or



Repair

WARNING 

1. ALWAYS refer to the operation manual when working near locations at which the alert mark shown on the left is attached. If the operation, etc., is performed without heeding the advice in the operation manual, there is a risk of personal injury. In addition, the equipment performance may be reduced. Moreover, this alert mark is sometimes used with other marks and descriptions indicating other dangers.
2. When supplying power to this equipment, connect the accessory 3-pin power cord to a grounded outlet. If a grounded outlet is not available, before supplying power to the equipment, use a conversion adapter and ground the green wire, or connect the frame ground on the rear panel of the equipment to ground. If power is supplied without grounding the equipment, there is a risk of receiving a severe or fatal electric shock.
3. This equipment cannot be repaired by the user. DO NOT attempt to open the cabinet or to disassemble internal parts. Only Anritsu-trained service personnel or staff from your sales representative with a knowledge of electrical fire and shock hazards should service this equipment. There are high-voltage parts in this equipment presenting a risk of severe injury or fatal electric shock to untrained personnel. In addition, there is a risk of damage to precision parts.

For Safety

CAUTION

Check Terminal



1. Never input a signal of more than the indicated value between the measured terminal and ground. Input of an excessive signal may damage the equipment.
-

Equipment Certificate

Anritsu Corporation certifies that this equipment was tested before shipment using calibrated measuring instruments with direct traceability to public testing organizations recognized by national research laboratories including the National Institute of Advanced Industrial Science and Technology, and the National Institute of Information and Communications Technology, and was found to meet the published specifications.

Anritsu Warranty

Anritsu Corporation will repair this equipment free-of-charge if a malfunction occurs within 1 year after shipment due to a manufacturing fault, provided that this warranty is rendered void under any or all of the following conditions.

- The fault is outside the scope of the warranty conditions described in the operation manual.
- The fault is due to mishandling, misuse, or unauthorized modification or repair of the equipment by the customer.
- The fault is due to severe usage clearly exceeding normal usage.
- The fault is due to improper or insufficient maintenance by the customer.
- The fault is due to natural disaster including fire, flooding, earthquake, etc.
- The fault is due to use of non-specified peripheral equipment, peripheral parts, consumables, etc.
- The fault is due to use of a non-specified power supply or in a non-specified installation location.

In addition, this warranty is valid only for the original equipment purchaser. It is not transferable if the equipment is resold.

Anritsu Corporation will not accept liability for equipment faults due to unforeseen and unusual circumstances, nor for faults due to mishandling by the customer.

Anritsu Corporation Contact

If this equipment develops a fault, contact Anritsu Service and Sales offices at the address at the end of paper-edition manual or the separate file of CD-edition manual.

CE Conformity marking

Anritsu affixes the CE Conformity marking on the following product (s) in accordance with the Council Directive 93/68/EEC to indicate that they conform to the EMC and LVD directive of the European Union (EU).

CE marking



1. Product Model

Plug-in Units: MU120010A T1/T3 Unit

2. Applied Directive and Standards

When the MU120010A T1/T3 Unit is installed in the MP1220A, the applied directive and standards of this Unit are conformed to those of the MP1220A main frame.

PS: About main frame

The kind of main frame (a measuring apparatus) will be to increase.

Please, contact us about the newest information of the main frame.

C-tick Conformity marking

Anritsu affixes the C-tick marking on the following product (s) in accordance with the regulation to indicate that they conform to the EMC framework of Australia/New Zealand.

C-tick marking



1. Product Model

Plug-in Units: MU120010A T1/T3 Unit

2. Applied Directive and Standards

When the MU120010A T1/T3 Unit is installed in the MP1220A, the applied directive and standards of this Unit are conformed to those of the MP1220A main frame.

PS: About main frame

The kind of main frame (a measuring apparatus) will be to increase.
Please, contact us about the newest information of the main frame.

PREFACE

Organization of This Manual

The MU120010A T1/T3 Unit is a plug-in unit that can be inserted into the MP1220A ATM Quality Analyzer. The Operation Manual is provided for each unit. A Remote Control Operation Manual is also provided for each unit (remote control software product is an option). Use these manuals as necessary.

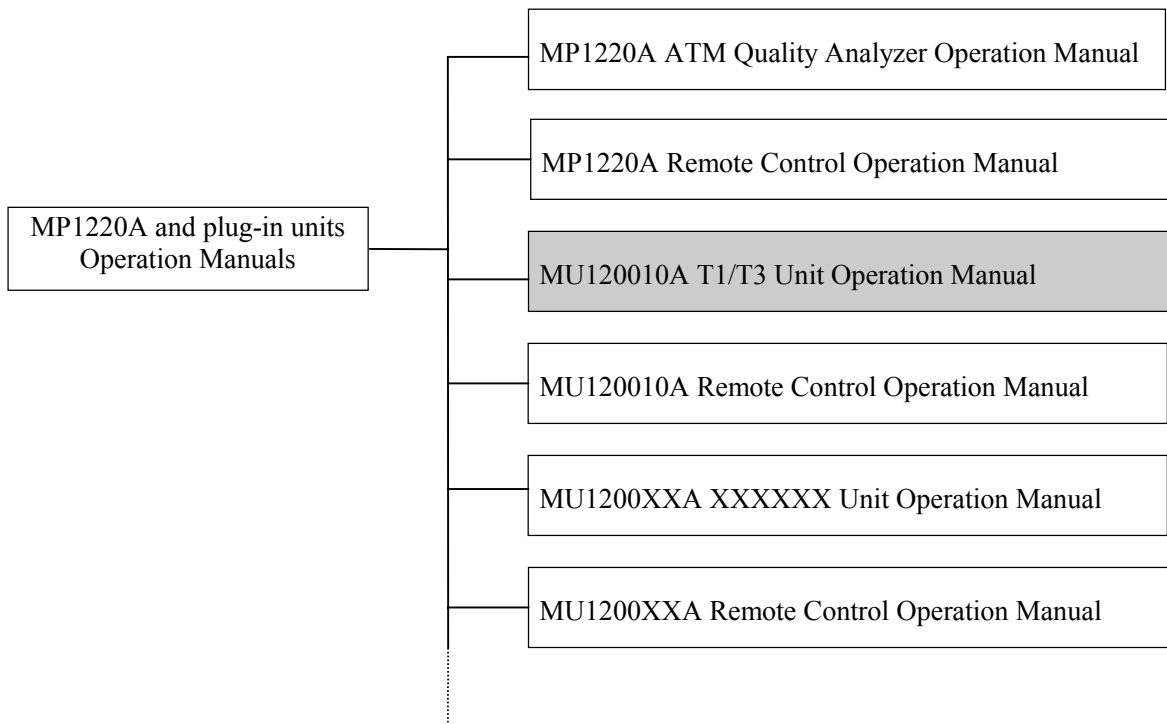

- **MP1220A ATM Quality Analyzer Operation Manual**
Outlines the MP1220A and describes the preparation, panels, specifications, performance, and operation.
- **MP1220A ATM Quality Analyzer Remote Control Operation Manual**
Describes the external interface control and contains sample programs.
- **Operation Manual for unit**
Describes the overview, specifications, performance, and operation of each unit.
- **Remote Control Operation Manual for each unit**
Describes the unit control via the external interface and contains sample programs.

CONTENTS

For Safety	iii
PREFACE	I
SECTION 1 OVERVIEW	1-1
1.1 Product Overview	1-1
1.2 Specifications	1-2
1.3 Hardware Configuration	1-5
1.3.1 Standard Configuration	1-5
1.3.2 Accessories	1-5
SECTION 2 PREPARATION	2-1
2.1 Ambient Requirements	2-1
2.2 Safety Precautions	2-2
SECTION 3 PANELS	3-1
3.1 Panel Layout and Description	3-1
SECTION 4 SCREENS	4-1
4.1 MU120010A T1/T3 Unit Window	4-1
4.2 Construction Panel	4-2
4.2.1 Setup-1 Panel	4-3
4.2.2 Setup-2 Panel	4-4
4.2.3 Search Condition Setup Dialog Box	4-5
4.3 Tx-Setup Panel	4-6
4.3.1 TC Setup Dialog Box	4-7
4.3.1.1 Byte Setup Dialog Box	4-8
4.3.2 Alarm/Error Setup Dialog Box	4-9
4.3.2.1 Alarm Panel	4-9
4.3.2.2 Error Panel	4-10
4.4 Rx-Setup Panel	4-11
4.4.1 TC Setup Dialog Box	4-12
4.4.2 Trigger Setup Dialog Box	4-13

4.5 Alarm/Error Panel	4-14
4.5.1 Layout Dialog Box	4-15
4.6 Analyze Panel	4-16
4.6.1 Jump Dialog Box	4-17
4.6.2 Analyze Setup Dialog Box	4-18

SECTION 5 MEASUREMENT **5-1**

5.1 Performance Measurement	5-1
-----------------------------------	-----

SECTION 6 PERFORMANCE TEST **6-1**

6.1 Performance Test	6-1
6.1.1 Alarm/Error Measurement Test	6-2

SECTION 7 MAINTENANCE **7-1**

7.1 Daily Maintenance	7-1
7.2 Storage	7-2
7.3 Transportation	7-3
7.4 Calibration	7-4

APPENDIX

APPENDIX A PERFORMANCE TEST RESULT SHEET	A-1
--	-----

INDEX

INDEX	I-1
-------------	-----

SECTION 1 OVERVIEW

1.1 Product Overview

The MU120010A T1/T3 Unit (hereafter called the unit), which is inserted into the slot on the MP1220A ATM Quality Analyzer (hereafter called the mainframe), adds and terminates 1.544 Mb/s and 44.736 Mb/s signal frames and performs HEC synchronization.

Features

- Can select High level and the transmission output level after the building-out line (DSX level)
- Can receive monitor level signals (20 dB attenuated from the DSX level).
- Loopback function
 - Reception loopback (loops back received signals within the unit and outputs them to an external unit, MU120020 QoS Unit, and MU120021A Protocol Unit)
 - Transmission loopback (outputs transmission signals to an external unit and, at the same time, loops them back to the receiver within the unit)
- Error/alarm measurement
 - Displays error ratios, error counts, error status, and alarm status.
- Cell count via HEC function
 - Number of cells discarded because of invalid headers
 - Number of corrected headers

1.2 Specifications

Table 1.1 lists the specifications of the unit.

Table 1-1 Specifications

No.	Item	Specifications																											
1 1.1	Input/output Transmission bit rate Output waveform Reception bit rate Input level Connector Cord	1.544Mb/s ± 10ppm Must satisfy the T1.102 (ANSI) (The building-out line can be set to ON/OFF.) 1.544Mb/s ± 130ppm 2.4~3.6 V o-p Monitor time : 0.24~0.36 V o-p 8-pin modular (conform to ISO/IEC10173) 100 Ω Balanced B8ZS																											
1.2	T3 Output Transmission bit rate Output waveform Connector Cord	44.736Mb/s ± 10ppm Must satisfy the T1.102 (ANSI) (The building-out line can be set to ON/OFF.) BNC75 Ω B3ZS																											
1.3	T3 Input Reception bit rate Input level Connector Cord	44.736Mb/s ± 20ppm 0.36~0.85 V o-p Monitor time : 0.036~0.085 V o-p BNC75 Ω Unbalanced B3ZS																											
1.4	T1 pin number change	<table border="1"> <thead> <tr> <th>Pin number</th> <th>→NT</th> <th>→TE</th> </tr> </thead> <tbody> <tr> <td>1</td> <td>Reception +</td> <td>Transmission +</td> </tr> <tr> <td>2</td> <td>Reception -</td> <td>Transmission -</td> </tr> <tr> <td>3</td> <td>Non-connection</td> <td>Non-connection</td> </tr> <tr> <td>4</td> <td>Transmission +</td> <td>Reception +</td> </tr> <tr> <td>5</td> <td>Transmission -</td> <td>Reception -</td> </tr> <tr> <td>6</td> <td>Non-connection</td> <td>Non-connection</td> </tr> <tr> <td>7</td> <td>GND</td> <td>GND</td> </tr> <tr> <td>8</td> <td>4.7n F to GND</td> <td>4.7n F to GND</td> </tr> </tbody> </table>	Pin number	→NT	→TE	1	Reception +	Transmission +	2	Reception -	Transmission -	3	Non-connection	Non-connection	4	Transmission +	Reception +	5	Transmission -	Reception -	6	Non-connection	Non-connection	7	GND	GND	8	4.7n F to GND	4.7n F to GND
Pin number	→NT	→TE																											
1	Reception +	Transmission +																											
2	Reception -	Transmission -																											
3	Non-connection	Non-connection																											
4	Transmission +	Reception +																											
5	Transmission -	Reception -																											
6	Non-connection	Non-connection																											
7	GND	GND																											
8	4.7n F to GND	4.7n F to GND																											
1.5	Ext Clk Input Frequency Level Connector	1.5M : 1.544Mb/s ± 130ppm (Pulse wave only) 45M : 44.736Mb/s ± 20ppm (Pulse wave only) 0.6~1.2 V p-p BNC50 Ω																											

No.	Item	Specifications												
1.6	Rcv Clk Output Frequency Level Connector	1.5M : 1.544Mb/s (Duty: : $50 \pm 10\%$, \pm ppm value depends on the input frequency.) 45M : 44.736Mb/s (Duty: : $50 \pm 20\%$, \pm ppm value depends on the input frequency.) 0.7~1.0V p-p, however the transmission clock is sent in the transmission to reception loopback. BNC50 Ω												
1.7	Trig Output Level Connector	TTL level (trigger time : L level) BNC75 Ω												
2	Operation mode													
2.1	Frame format	<table border="1"> <thead> <tr> <th></th> <th>PLCP(on)</th> <th>PLCP(off)</th> </tr> </thead> <tbody> <tr> <td>1.5M-ESF</td> <td style="text-align: center;">○</td> <td style="text-align: center;">○</td> </tr> <tr> <td>45M-Cbit</td> <td style="text-align: center;">○</td> <td style="text-align: center;">○</td> </tr> <tr> <td>45M-M23</td> <td style="text-align: center;">○</td> <td style="text-align: center;">○</td> </tr> </tbody> </table>		PLCP(on)	PLCP(off)	1.5M-ESF	○	○	45M-Cbit	○	○	45M-M23	○	○
	PLCP(on)	PLCP(off)												
1.5M-ESF	○	○												
45M-Cbit	○	○												
45M-M23	○	○												
2.2	Measurement mode	Input and output are mutually independent. The reception signal is looped back to transmission stage. The transmission signal is looped back to reception stage inside the unit.												
3	Unit trough function Transmission through Reception through	The cell from the lower unit can be passed through the upper unit. The cell from the upper unit can be passed through the lower unit.												
4	Transmission function													
4.1	Network type	UNI/NNI												
4.2	Clock selection	Internal, External, Received												
4.3	TC function Transmission free cell setting Transmission scramble cell Transmission coset processing	GFC, PT, CLP, HEC and Payload. (48 bytes are same value as bite unit.) ON/OFF ON/OFF												
4.4	Error addition Type Timing Burst Error addition word Error mask	Bit, FEBE, PLCP-BIP-8, PLCP-FEBE, Cell Single, 1×10^{-n} (n=3,4,5,6,7,8,9) , ALL ALL for PLCP-BIP-8 n=4, 5, 6, 7, 8, 9 for FEBE. n=3, 4, 5, 6 for Cell. 1~64 (Cell only) Specifies any bite in Cell. (Cell only) Specifies Bit mask. (Cell time only)												
4.5	Alarm addition Type Timing	LOS, LOF, AIS, Yellow, Idle, PLCP-LOF, PLCP-Yellow, LCD ALL												

SECTION1 OVERVIEW

No.	Item	Specifications
5	Reception function	
5.1	Network type	UNI/NNI
5.2	1023ch measurement function Setting	Type selection : VP or VC Default channel : ON/OFF Channel number : 1~1023 Setting channel search time : 5~99sec (1second unit) 1~99min(1 minute unit)
5.3	TC function Cell de-scramble Coset processing HEC error correction	ON/OFF ON/OFF ON/OFF
5.4	Monitor level	ON/OFF
5.5	Error detection Type Display	Code, CP, FEBE, CRC6, PLCP-BIP-8, PLCP-FEBE, Corrected Cell, Discarded Cell Count display : 0~999999, 1.00E06~9.99E15, >9.99E15 Error second display : 0~999999, 1.00E06~9.99E15, >9.99E15 [s] Rate display : 1.00E-15~1.00E00, 0.00E00~0.00E-15, >1.00E-15
5.6	Alarm detection Type Display	LOS, OOF, AIS, Yellow, Idle, PLCP-Yellow, PLCP-OOF, LCD However LOS is not displayed in the transmission to reception loopback. 0~999999, 1.00E06~9.99E15, >9.99E15 [s]
5.7	Analyze function	Displays the detected Error/Alarm in the graph.
6	Trigger generation Type Port connection Trigger output Internal trigger	LCD ON/OFF Internal-1/Internal-2 Internal-1/Internal-2
7	Mechanical Dimension Mass	29.5(H)×169(W)×241(D) [mm] 1.0kg or less
8	Environmental performance	Conforms to the mainframe specifications.

1.3 Hardware Configuration

1.3.1 Standard Configuration

Table 1-2 lists the standard configuration of the unit.

Table 1-2 Standard Configuration

Item	Model	Description	Quantity	Remarks
This unit	MU120010A	T1/T3 Unit	1	
Accessory	NW1310AE	MU120010A Operation Manual	1	
	MW1316AE	MU120010A Remote Control Operation Manual	1	

1.3.2 Accessories

Table 1-3 lists the accessories of the unit.

Table 1-3 Accessories

Model	Description	Quantity
J0775D	75 Ω coaxial cable, 75 Ω BNC plug at both ends,2m	1
J0776D	50 Ω coaxial cable, 50 Ω BNC plug at both ends,2m	1
J0844A	ISO-10173 cable	1

SECTION1 OVERVIEW

SECTION 2 PREPARATION

2.1 Ambient Requirements

Use the unit in a place where:

1. the temperature is between 5°C and 50°C and the humidity is between 45% and 85%.
2. there is no direct sunlight or much dust.
3. the unit is not exposed to water or active gas.
4. the unit is not oxidized and there is no vibration.

2.2 Safety Precautions

- Use this unit only on an MP1220A ATM Quality Analyzer. Failure to follow this may result in damage or accidents.
- Apply only the rated voltage to the unit. Applying a different voltage may result in circuit damage.
- When the unit is stored in a cold place for a long time and then used in a place with a higher ambient temperature, the unit may become wet with dew and there may be a short in the circuit. In this case, dry the unit before use.
- To avoid static electricity, be sure to connect a ground line to other units before connecting an input/output terminal.
- The outer conductor or the core line may act as a capacitor. So, discharge them with a metallic object before use.

SECTION 3 PANELS

3.1 Panel Layout and Description

Figure 3-1 shows the front panel of the unit, and Table 3-1 describes it.

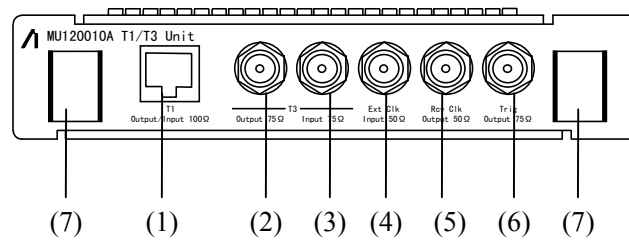

Figure 3-1 MU120010A Front Panel

Table 3-1 MU120010A Front Panel Description

No.	Label	Description																											
(1)	T1 Output/Input 100Ω	1.5M signal input/output connector <table border="1" style="margin-left: 20px;"> <thead> <tr> <th>Pin No.</th> <th>→NT</th> <th>→TE</th> </tr> </thead> <tbody> <tr> <td>1</td> <td>Reception +</td> <td>Transmission +</td> </tr> <tr> <td>2</td> <td>Reception -</td> <td>Transmission -</td> </tr> <tr> <td>3</td> <td>Not connected</td> <td>Not connected</td> </tr> <tr> <td>4</td> <td>Transmission +</td> <td>Reception +</td> </tr> <tr> <td>5</td> <td>Transmission -</td> <td>Reception -</td> </tr> <tr> <td>6</td> <td>Not connected</td> <td>Not connected</td> </tr> <tr> <td>7</td> <td>GND</td> <td>GND</td> </tr> <tr> <td>8</td> <td>4.7n F to GND</td> <td>4.7n F to GND</td> </tr> </tbody> </table>	Pin No.	→NT	→TE	1	Reception +	Transmission +	2	Reception -	Transmission -	3	Not connected	Not connected	4	Transmission +	Reception +	5	Transmission -	Reception -	6	Not connected	Not connected	7	GND	GND	8	4.7n F to GND	4.7n F to GND
Pin No.	→NT	→TE																											
1	Reception +	Transmission +																											
2	Reception -	Transmission -																											
3	Not connected	Not connected																											
4	Transmission +	Reception +																											
5	Transmission -	Reception -																											
6	Not connected	Not connected																											
7	GND	GND																											
8	4.7n F to GND	4.7n F to GND																											
(2)	T3 Output 75Ω	45M signal output connector (BNC)																											
(3)	T3 Input 75Ω	45M signal input connector (BNC)																											
(4)	Ext Clk Input 50Ω	External clock input connector (BNC)																											
(5)	Rev Clk Output 50Ω	Received clock output connector (BNC)																											
(6)	Trig Output 75Ω	Trigger output connector (BNC)																											
(7)	(Ejector)	Unit insertion ejector																											

SECTION3 PANELS

SECTION 4 SCREENS

4.1 MU120010A T1/T3 Unit Window

The MU120010A T1/T3 Unit Window allows you to set up the unit and to display the result. You can call it from the tool bar of the MP1220A ATM Quality Analyzer window. For details, see the MP1220A ATM Quality Analyzer Operation Manual.

The MU120010A T1/T3 Unit Window consists of the following panels:

Table 4-1 Component Panels

Panel name	Main use
Construction panel	Sets up the transmission/reception interface.
Tx-Setup panel	Sets up the transmission function.
Rx-Setup panel	Sets up the reception function.
Alarm/Error panel	Displays the alarm/error measurement results.
Analyze panel	Displays alarm/error history data. But, this panel is only displayed when the Logging of Measurement-1 panel is set ON in Mainframe window. (Refer to the MP1220A ATM Quality Analyzer Operation Manual)

Figure 4-1 shows the MU120010A T1/T3 Unit Window.

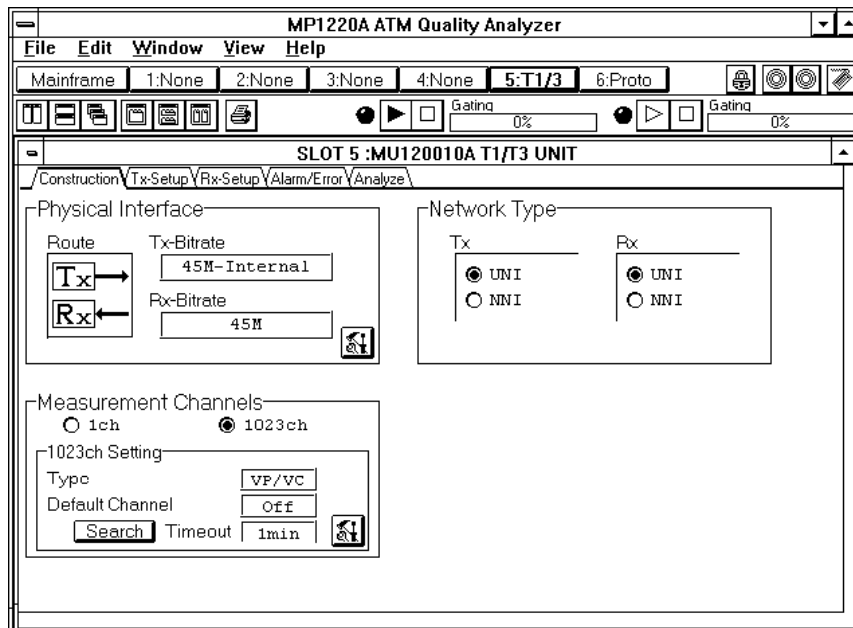

Figure 4-1 MU120010A T1/T3 Unit Window

4.2 Construction Panel

Figure 4-2 shows the Construction panel, and Table 4-2 describes the panel.

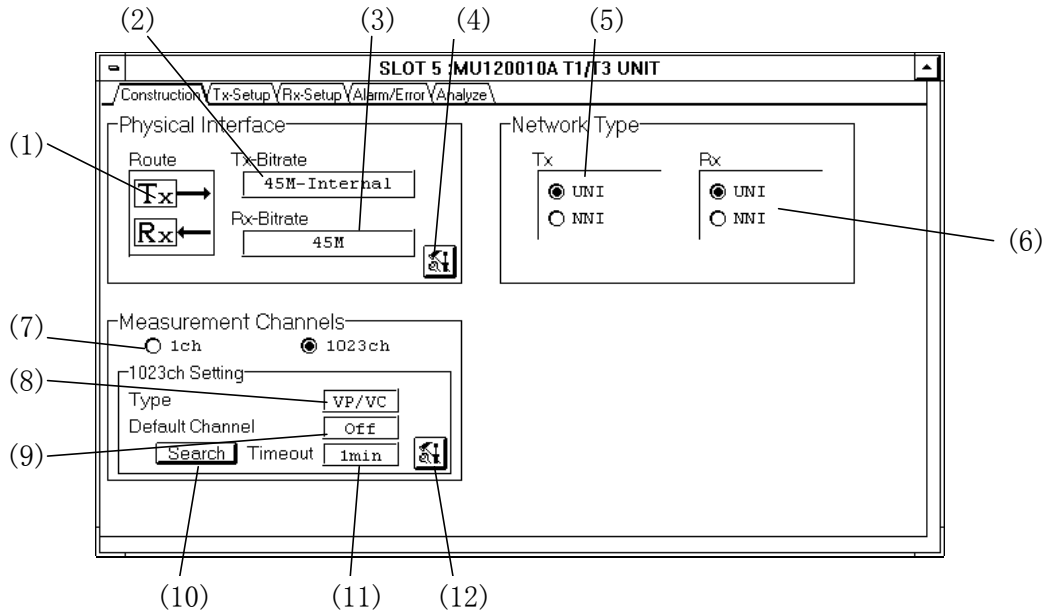

Figure 4-2 Construction Panel

Table 4-2 Construction Panel Description

No.	Item	Description
(1)	Route	Displays the routing of signals within the unit.
(2)	Tx-Bitrate	Displays the bit rate and type of clock in the transmission unit.
(3)	Rx-Bitrate	Displays the bit rate in the reception unit.
(4)		Opens the Physical Interface Setup dialog box.
(5)	Tx	Transmission network type
(6)	Rx	Reception network type.
(7)	Measurement Channels	Sets the monitor of the band width of each channel and AIS/RDI status in ATM network. (Live-Monitor measurement) The MU120020A QoS Unit and MU120021A Protocol Unit are needed for selecting "1023ch" of the Live-Monitor measurement. 1ch : Selects the monitor for 1ch. 1023ch : Selects the monitor for 2ch to 1023ch at the same time. When set "1023ch" at "Repeat" in measurement mode, the warning dialog box appears and the setting returns to "1ch".
(8)	Type	Displays the type of the channel for "1023ch."
(9)	Default Channel	Displays whether or not the default channel setting is enabled.
(10)	Search	Starts searching "1023ch".
(11)	Time Out	Displays the time-out period for "1023ch" search.
(12)		Opens the Search Condition setup dialog box. You cannot specify values during measurement.

4.2.1 Setup-1 Panel

Figure 4-3 shows the Setup-1 panel, and Table 4-3 describes the panel.

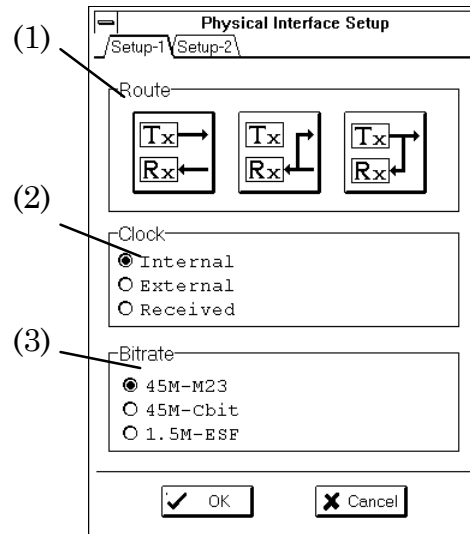





Figure 4-3 Setup-1 Panel

Table 4-3 Setup-1 Panel Description

No.	Item	Description
(1)	Route	<p>Selects the routing of signals in the unit.</p> <p> : The transmission module and the reception module operate independently of each other.</p> <p> : Reception loopback operation</p> <p> : Transmission loopback operation</p>
(2)	Clock	<p>Selects the clock signals used for the transmission module.</p> <p>Internal : Internal clock signal External : Clock signal from the external connector Received : Clock signal re-generated from received data</p>
(3)	Bitrate	<p>45M-M23 : The bit rate of 45M(T3) and frame format of M23 frame are used.</p> <p>45M-Cbit : The bit rate of 45M(T3) and frame format of Cbit parity frame are used.</p> <p>1.5M-ESF : The bit rate of 1.5M(T1) and frame format of Extended Super Frame are used.</p>

4.2.2 Setup-2 Panel

Figure 4-4 shows the Setup-2 panel, and Table 4-4 describes the panel.

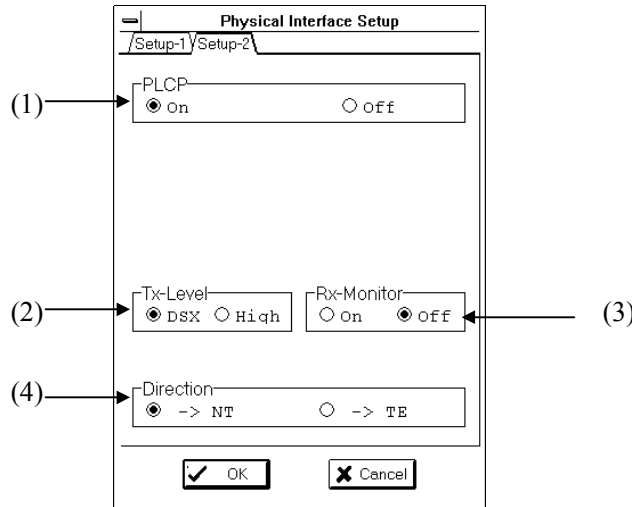

Figure 4-4 Setup-2 Panel

Table 4-4 Setup-2 Panel Description

No.	Item	Description																											
(1)	PLCP	Specifies whether to add the PLCP frame to the bit rate and the frame you selected in 4.2.1 (3). On : Add the PLCP frame. Off : Do not add the PLCP frame.																											
(2)	Tx-Level	Selects the transmission signal output level. DSX : The transmission signal is output at the level after the building-out line. High : The point where the transmission signal passes 225- to 450-foot cable is the DSX level.																											
(3)	Rx-Monitor	Selects the reception signal input level. On : The signal attenuated by 20 dB (monitor point) is connected. Off : The output from the unit is directly connected.																											
(4)	Direction	Specifies the destination to which the 1.5M signal is sent. This field is effective only when you selected "1.5M-ESF" in 4.2.1 (3). This setting changes the pin setting of the T1 Output/Input 100 Ω connector.																											
		<table border="1"> <thead> <tr> <th>Pin No.</th> <th>→NT</th> <th>→TE</th> </tr> </thead> <tbody> <tr> <td>1</td> <td>Reception +</td> <td>Transmission +</td> </tr> <tr> <td>2</td> <td>Reception -</td> <td>Transmission -</td> </tr> <tr> <td>3</td> <td>Not connected</td> <td>Not connected</td> </tr> <tr> <td>4</td> <td>Transmission +</td> <td>Reception +</td> </tr> <tr> <td>5</td> <td>Transmission -</td> <td>Reception -</td> </tr> <tr> <td>6</td> <td>Not connected</td> <td>Not connected</td> </tr> <tr> <td>7</td> <td>GND</td> <td>GND</td> </tr> <tr> <td>8</td> <td>4.7n F to GND</td> <td>4.7n F to GND</td> </tr> </tbody> </table>	Pin No.	→NT	→TE	1	Reception +	Transmission +	2	Reception -	Transmission -	3	Not connected	Not connected	4	Transmission +	Reception +	5	Transmission -	Reception -	6	Not connected	Not connected	7	GND	GND	8	4.7n F to GND	4.7n F to GND
Pin No.	→NT	→TE																											
1	Reception +	Transmission +																											
2	Reception -	Transmission -																											
3	Not connected	Not connected																											
4	Transmission +	Reception +																											
5	Transmission -	Reception -																											
6	Not connected	Not connected																											
7	GND	GND																											
8	4.7n F to GND	4.7n F to GND																											

4.2.3 Search Condition Setup Dialog Box

Figure 4-5 shows the Search Condition Setup dialog box, and Table 4-5 describes the dialog box.

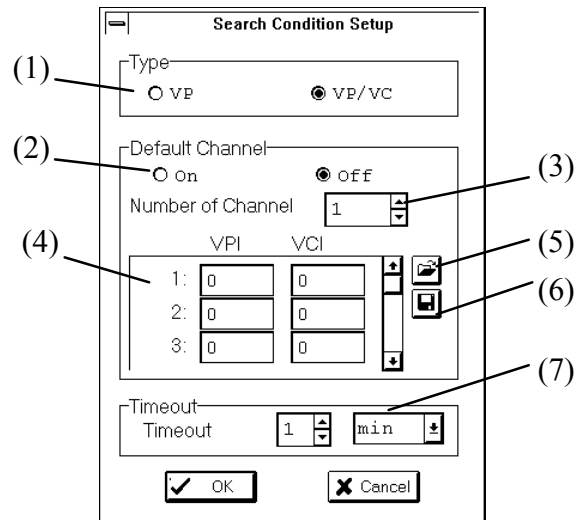



Figure 4-5 Search Condition Setup dialog Box

Table 4-5 Search Condition Setup Dialog Box Description

No.	Item	Description
(1)	Type	Selects the type of the cell to be searched for.
(2)	Default Channel	Specifies whether to enable the default channel setting.
(3)	Number of Channel	Specifies the number of channels to be searched.
(4)		Specifies the VPI and VCI values.
(5)		Reads the default channel setting from the file.
(6)		Saves the default channel setting into the file.
(7)	Time Out	Specifies the "1023ch" search time-out period.

4.3 Tx-Setup Panel

Figure 4-6 shows the Tx-Setup panel, and Table 4-6 describes the panel.

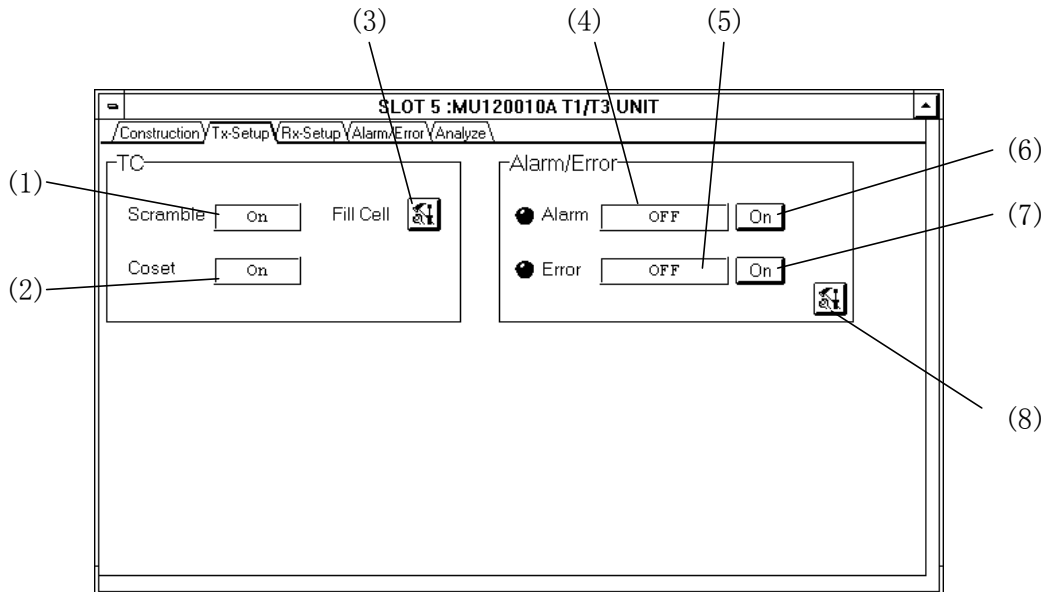



Figure 4-6 Tx-Setup Panel

Table 4-6 Tx-Setup Panel Description

No.	Item	Description
(1)	Scramble	Displays whether to scramble the payload of the transmission cell.
(2)	Coset	Displays whether to perform coset processing for the transmission cell HEC.
(3)	Fill Cell 	Opens the TC Setup dialog box.
(4)	Alarm	Displays the type of alarm that is set up.
(5)	Error	Displays the type of error that is set up.
(6)	On/Off	Adds the alarm displayed in (4).
(7)	On/Off	Adds the error displayed in (5).
(8)		Opens the Alarm/Error Setup dialog box.

4.3.1 TC Setup Dialog Box

Figure 4-7 shows the TC Setup dialog box, and Table 4-7 describes the dialog box.

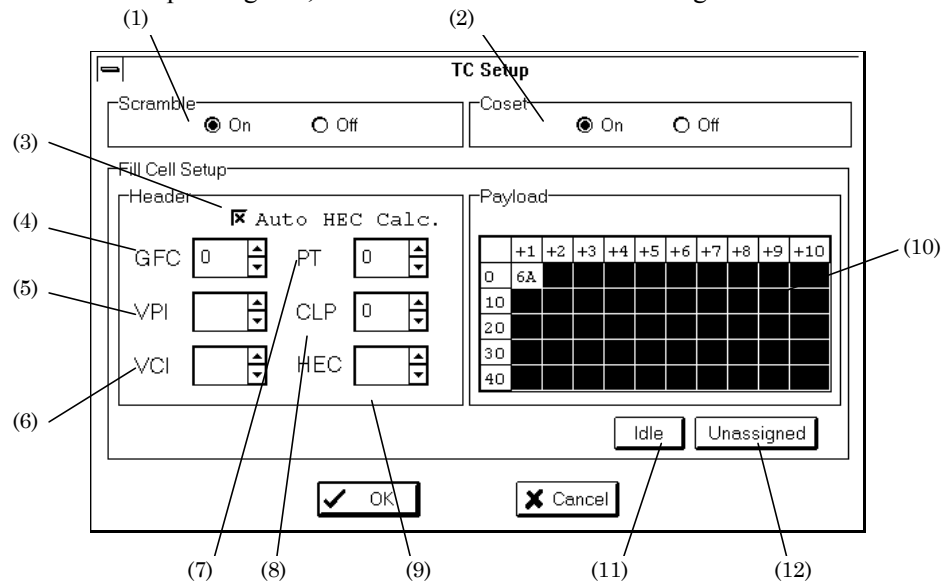

Figure 4-7 TC Setup Dialog Box

Table 4-7 TC Setup Dialog Box Description

No.	Item	Description
(1)	Scramble	Specifies whether to scramble the payload of the transmission cell.
(2)	Coset	Specifies whether to perform coset processing for the transmission cell HEC.
(3)	Auto HEC Calc.	Specifies whether HEC is to be calculated automatically and added.
(4)	GFC	Specifies a GFC value. You cannot specify a GFC value if NNI was selected in 4.2 (5).
(5)	VPI	Displays the VPI value. The value is always 0.
(6)	VCI	Displays the VCI value. The value is always 0.
(7)	PT	Specifies a PT value.
(8)	CLP	Specifies a CLP value.
(9)	HEC	Specifies an HEC value. You cannot specify an HEC value if the Auto HEC Calc check box was turned on in (1).
(10)	Payload	Specifies a payload value. Double click on the frame of crossing the vertical position 0 and horizontal position +1, then Byte Setup dialog box is opened.
(11)	Idle	Pressing this button displays the contents of an Idle cell in the Header group box and Payload group box. The contents of an Idle cell include GFC : 0, VPI : 0, VCI : 0, PT : 0, CLP : 1, HEC : calculated, and payload: 6A.
(12)	Unassigned	Pressing this button displays the contents of an Unassigned cell in the Header group box and Payload group box. The contents of an Unassigned cell include GFC : 0, VPI : 0, VCI : 0, PT : 0, CLP : 0, HEC : calculate, and payload: 6A.

4.3.1.1 Byte Setup Dialog Box

Figure 4-8 shows the Byte Setup dialog box, and Table 4-8 describes the dialog box.

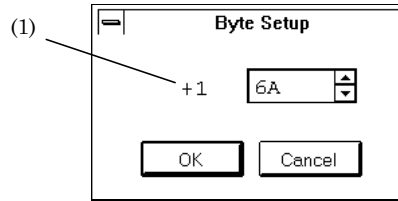

Figure 4-8 Byte Setup Dialog Box

Table 4-8 Byte Setup Dialog Box Description

No.	Item	Description
(1)		Specifies a payload value. All 48 bytes are set to the specified value.

4.3.2 Alarm/Error Setup Dialog Box

4.3.2.1 Alarm Panel

Figure 4-9 shows the Alarm panel, and Table 4-9 describes the panel.

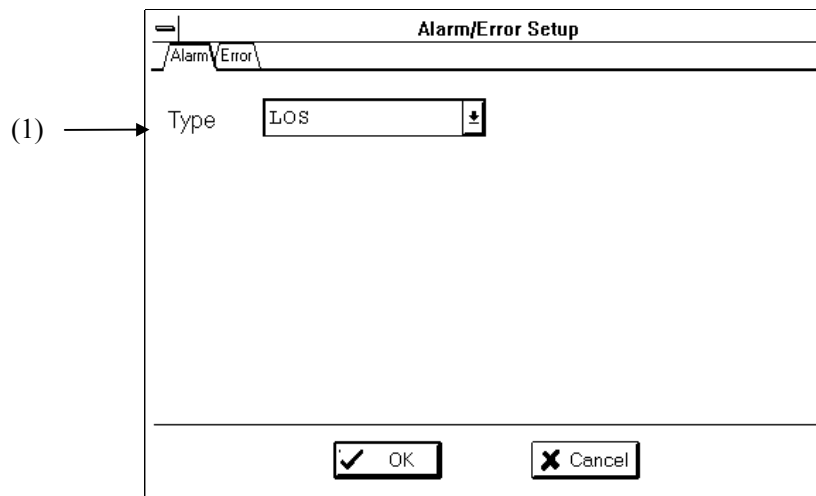

Figure 4-9 Alarm Panel

Table 4-9 Alarm Panel Description

No.	Item	Description
(1)	Type	Selects the type of the alarm to be added.

4.3.2.2 Error Panel

Figure 4-10 shows the Error panel, and Table 4-10 describes the panel.

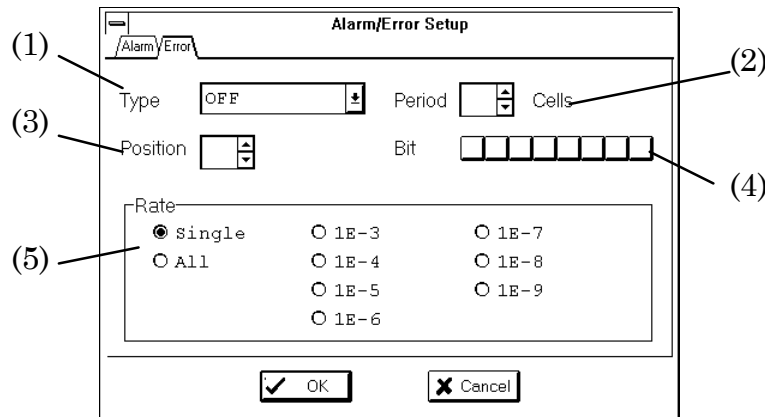

Figure 4-10 Error Panel

Table 4-10 Error Panel Description

No.	Item	Description
(1)	Type	Selects the type of the error to be added. When you select Cell, the warning dialog box will appear and prompt you to confirm the condition when you selected Bit on the setup screen of the MU120020A QoS unit or MU120021A protocol unit.
(2)	Period	Specifies the number of contiguous errored cells for which you want an error message displayed. You can specify a value ranging from 1 to 64. You can specify this value only if you selected Cell in (1).
(3)	Position	Specifies the byte position in the cell where bits values are to be inverted. You can specify this option only if you selected Cell in (1).
(4)	Bit	Specifies the bits whose values are to be inverted. You can specify this option only if you selected Cell in (1).
(5)	Rate	Selects the error addition timing. You can select from Single, All, or a rate (1E-n = 3, 4, 5, 6, 7, 8, 9).

4.4 Rx-Setup Panel

Figure 4-11 shows the Rx-Setup panel, and Table 4-11 describes the panel.

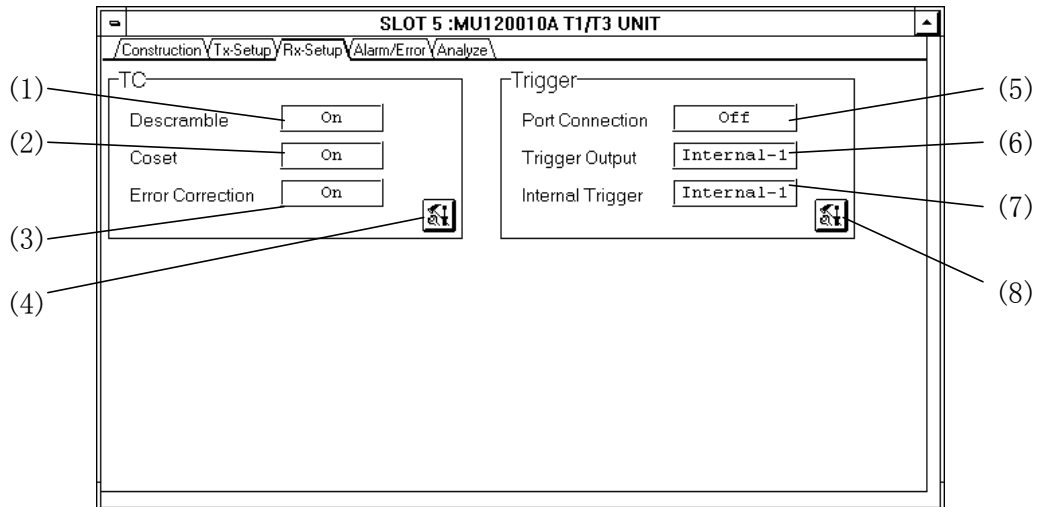



Figure 4-11 Rx-Setup Panel

Table 4-11 Rx-Setup Panel Description

No.	Item	Description
(1)	Descramble	Displays the setting at paragraph 4.4.1(1).
(2)	Coset	Displays the setting at paragraph 4.4.1(2).
(3)	Error Correction	Displays the setting at paragraph 4.4.1(3).
(4)		Open the TC Setup dialog box.
(5)	Port Connection	The trigger signal is shared in the unit group.
(6)	Trigger Output	Displays whether or not the trigger signal is to be sent to the Ext Trig Output connector.
(7)	Internal Trigger	Displays whether or not the trigger signal (LCD) is to be output to the trigger line.
(8)		Opens the Trigger Setup dialog box.

4.4.1 TC Setup Dialog Box

Figure 4-12 shows the TC Setup Dialog box, and Table 4-12 describes the panel.

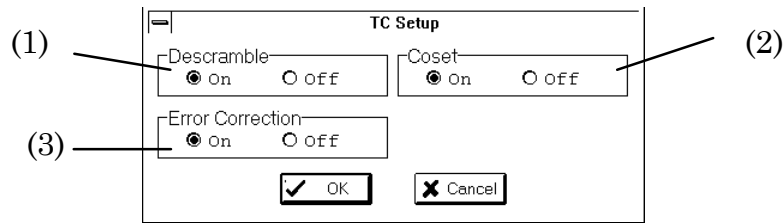

Figure 4-12 TC Setup Dialog Box

Table 4-12 TC Setup Dialog Box Description

No.	Item	Description
(1)	Descramble	Specifies whether or not the payload of the reception cell is to be descrambled.
(2)	Coset	Specifies whether or not coset processing is to be performed on the HEC of the reception cell.
(3)	Error Correction	Specifies whether or not an HEC correction is to be made on the reception.

4.4.2 Trigger Setup Dialog Box

Figure 4-13 shows the Trigger Setup dialog box, and Table 4-13 describes the dialog box.

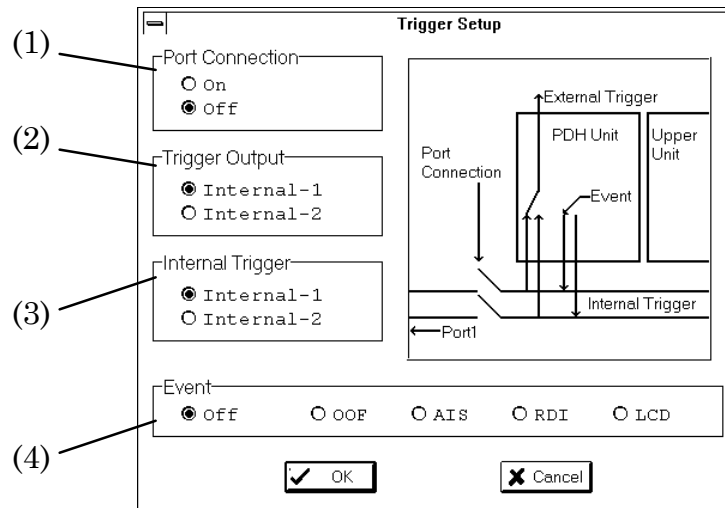

Figure 4-13 Trigger Setup Dialog Box

Table 4-13 Trigger Setup dialog Box Description

No.	Item	Description
(1)	Port Connection	Trigger signal is shared in the unit group when select On.
(2)	Trigger Output	Specifies whether or not the trigger signal is to be output to the Ext Trig Output connector. Off : Does not output the trigger signal to the Ext Trig Output connector. Internal-1 : The trigger signal is sent from trigger line 1 to the Ext Trig Output connector. Internal-2 : The trigger signal is sent from trigger line 2 to the Ext Trig Output connector.
(3)	Internal Trigger	Specifies whether or not the trigger signal (LCD) is to be output to the trigger line. Off : Does not output the trigger signal to trigger line 1 and 2. Internal-1 : The trigger signal is sent to trigger line 1. Internal-2 : The trigger signal is sent to trigger line 2.
(4)	Event	Displays the type of trigger signal.

4.5 Alarm/Error Panel

Figure 4-14 show the Alarm/Error panel, and Table 4-14 describes the panel.

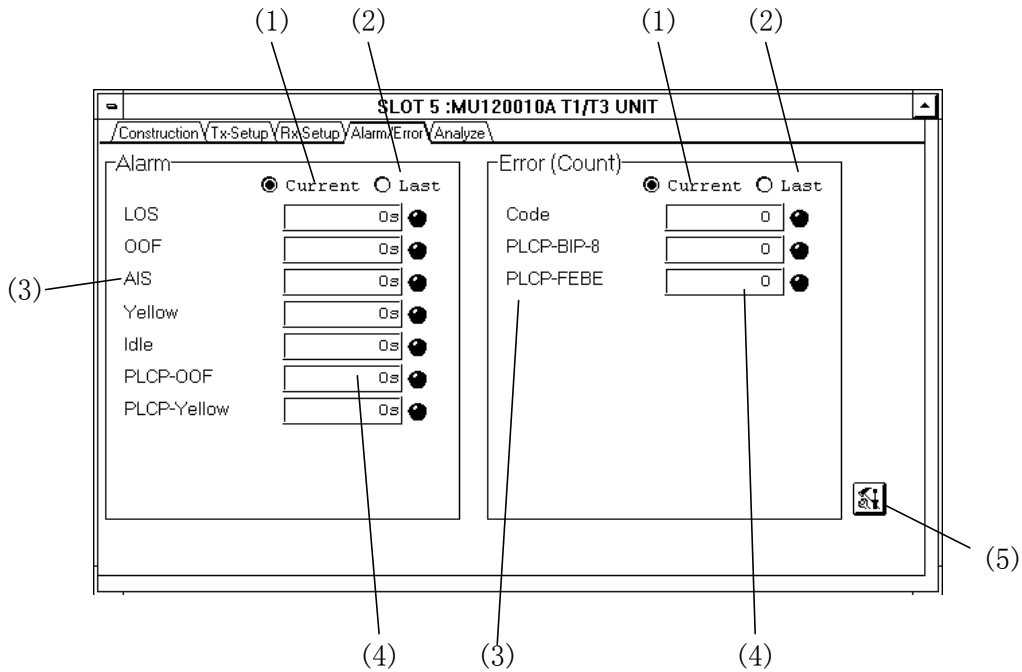

Figure 4-14 Alarm/Error Panel

Table 4-14 Alarm/Error Panel Description

No.	Item	Description
(1)	Current	Displays the results from the beginning to the current time.
(2)	Last	Displays the result at the end of measurement.
(3)		Displays all the alarms, errors, and cells for the specified reception bit rate and frame.
(4)	LED	Displays the status of the alarm, error, and cell. Red : Active Orange : Occurred during measurement (when "Current" is selected) Occurred during previous measurement (when "Last" is selected)
(5)		Opens the Layout dialog box.

4.5.1 Layout Dialog Box

Figure 4-15 shows the Layout dialog box, and Table 4-15 describes the dialog box.

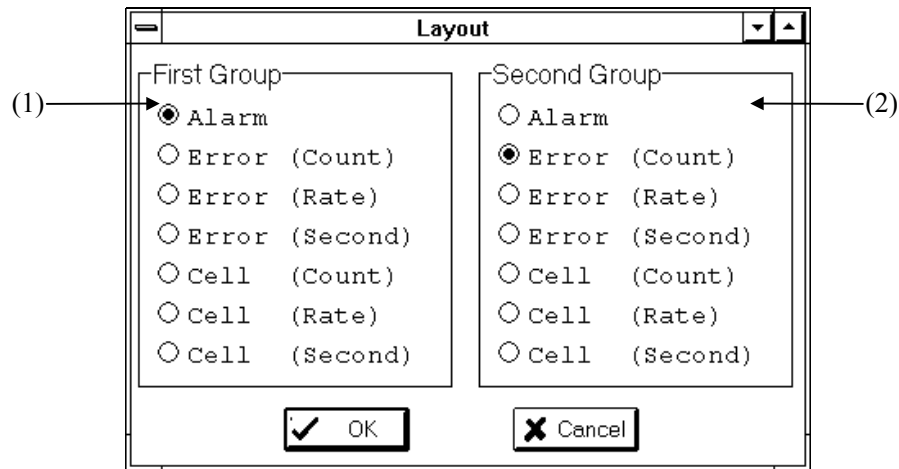

Figure 4-15 Layout Dialog Box

Table 4-15 Layout Dialog Box Description

No.	Item	Description
(1)	First Group	Selects the group boxes to be displayed on the Alarm/Error panel. Select them from Alarm, Error (Count, Rate, Second), and Cell (Count, Rate, Second). On a horizontally-split screen (Lengthwise) and a full screen, the selected boxes are displayed on the left side. On a vertically-split screen (Widthwise), the selected boxes are displayed in the top half.
(2)	Second Group	Specify the desired boxes as for the First Group. On a vertically-split screen (Widthwise), the selected boxes are displayed in the bottom half.

4.6 Analyze Sheet

Figure 4-16 shows the Analyze panel, and Table 4-16 describes the panel.

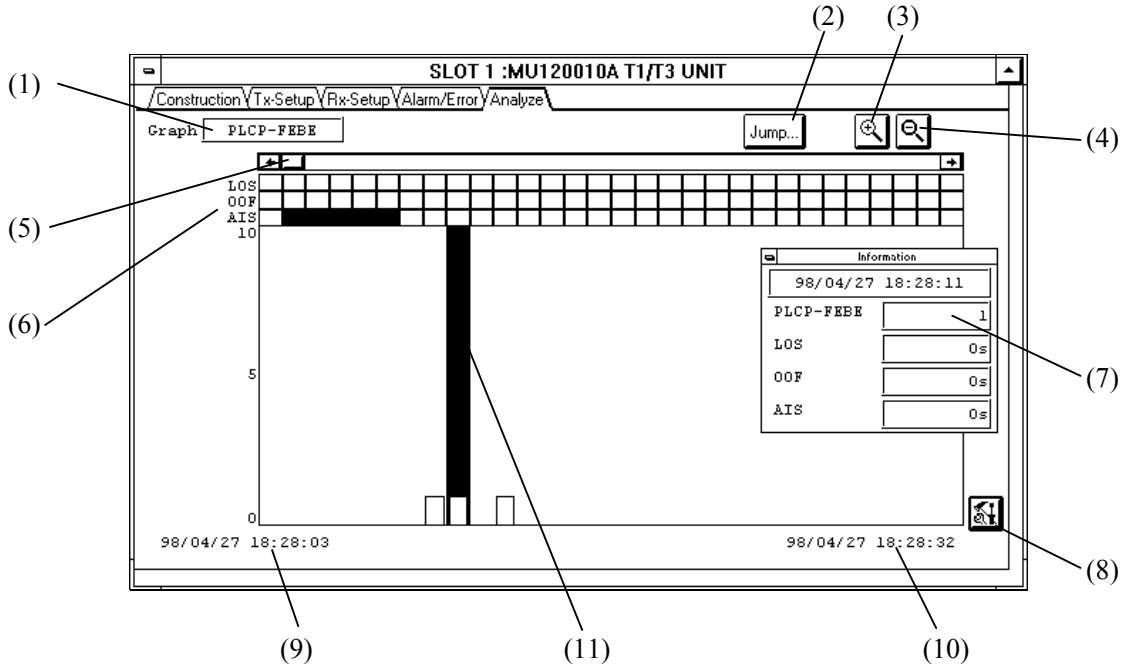





Figure 4-16 Analyze Panel

Table 4-16 Analyze Panel Description

No.	Item	Description
(1)	Graph	Displays the type of error to be displayed in the graph format. To change this setting, use the Analyze Setup dialog box.
(2)	Jump	Opens the Jump dialog box.
(3)		Magnifies the graph. The graph is magnified so that the portion of the graph where the marker is located is displayed in the center of the screen.
(4)		Reduces the graph. The graph is reduced so that the portion of the graph where the marker is located is displayed in the center of the screen.
(5)		Scrolls the screen horizontally.
(6)		Displays alarms. Up to three alarms may be displayed at a time.
(7)		Displays the marker position time and detailed error/alarm data on that position.
(8)		Opens the Analyze Setup dialog box.
(9)		Displays the start time of the displayed graph.
(10)		Displays the end time of the displayed graph.
(11)		The marker for specifying one bar in the bar graph. Specify it by clicking the bar or Jump dialog box.

4.6.1 Jump Dialog Box

Figure 4-17 shows the Jump dialog box, and Table 4-17 describes the dialog box.

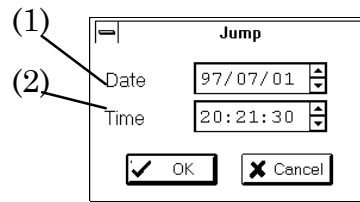

Figure 4-17 Jump Dialog Box

Table 4-17 Jump Dialog Box Description

No.	Item	Description
(1)	Date	Specifies the date of the marker position to be moved.
(2)	Time	Specifies the time of the marker position to be moved.

4.6.2 Analyze Setup Dialog Box

Figure 4-18 shows the Analyze Setup dialog box, and Table 4-18 describes the dialog box.

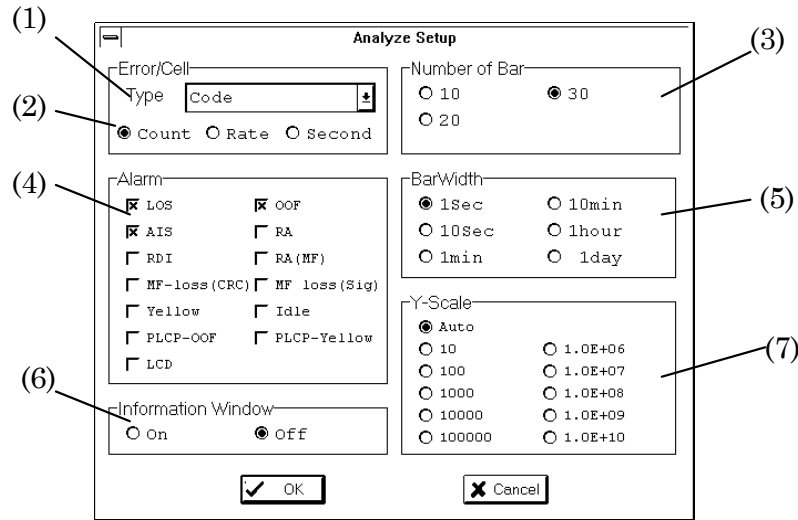

Figure 4-18 Analyze Setup Dialog Box

Table 4-18 Analyze Setup Dialog Box Description

No.	Item	Description
(1)	Type	Select an error or a cell to be displayed in the graph. Only one error/cell may be displayed at a time.
(2)		Selects the type of error display format: Count : Displays the number of errors. Rate : Displays the error rate. Second : Displays the number of seconds for an error.
(3)	Number of Bar	Selects the number of bar graphs to be displayed on one screen.
(4)	Alarm	Selects the alarms to be displayed in the graph. Up to three alarms may be displayed at a time.
(5)	Bar Width	Selects the period of time indicated by one bar in the bar graph.
(6)	Information Window	Specifies whether the items specified in 4.6 (8) are to be displayed in the Analyze sheet.
(7)	Y-Scale	Selects the vertical axis of the graph. Auto : The minimum vertical axis on which the maximum value can be displayed is selected automatically.

SECTION 5 MEASUREMENT

5.1 Performance Measurement

1. Connection

Connect the unit and turn it on as shown in Figure 5-1.

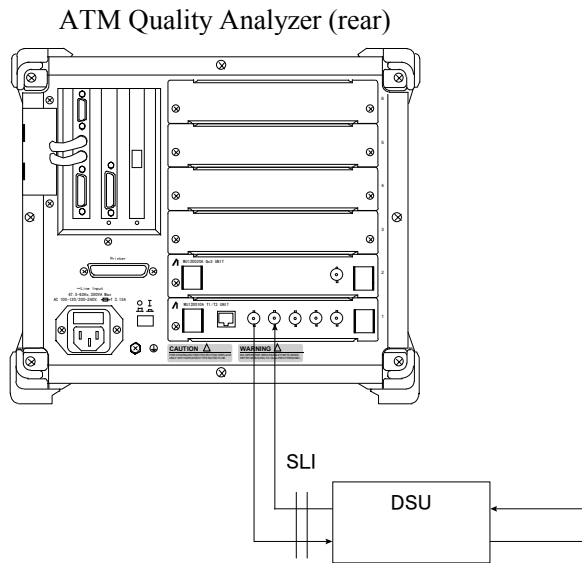



Figure 5-1 Performance Measurement Connection Diagram

2. Physical interface setup

Open the Physical Interface dialog box in the Physical Interface group box on the Construction panel. Set up the physical interface on the Setup-1 panel as follows:

Route : 

Clock : Internal

Bitrate : 45M-M23

3. Measurement results

Open the Layout dialog box on the Alarm/Error panel. Set up Error (Count), Error (Rate), and Error (Second) in the First Group group box or Second Group group box. Pressing the measurement start button (Go button) displays the error measurement results on the Alarm/Error panel. To display the current result, select Current; to display the final result, select Last.

4. Analyze

Open the Analyze panel when the log file is specified on the main frame. Information on errors and their occurrence times is displayed.

CHAPTER5 MEASUREMENT

SECTION 6 PERFORMANCE TEST

6.1 Performance Test

This section explains the performance test that is used to check if the unit is operating correctly. For the test procedure (how to insert the unit into the main frame, turn on the unit, and open MU120010A T1/T3 Unit Window), see the MP1220A ATM Quality Analyzer Operation manual.

Appendix A contains the performance test result sheet.

6.1.1 Alarm/Error Measurement Test

1. Connection

Connect the unit and turn it on as shown in Figure 6-1.

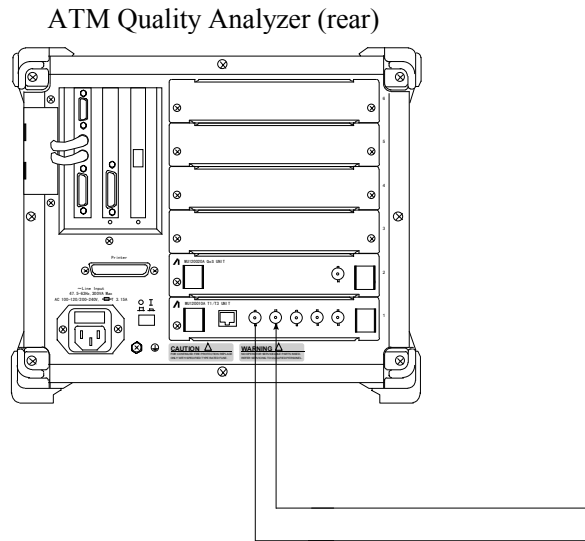
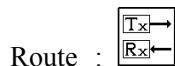

Figure 6-1 Alarm/Error Measurement Connection Diagram

2. Physical interface setup

Open the Physical Interface dialog box in the Physical Interface group box on the Construction panel. Set up the physical interface on the Setup-1 panel as follows:



Clock : Internal
 Bitrate : 45M-Cbit

Set up the Setup-2 panel as follows:

PLCP : On
 Tx-Level : DSX
 Rx-Level : Off

3. Measurement results

Open the Layout dialog box on the Alarm/Error panel. Set up Alarm, Error (Count), Error (Rate), Error (Second), Cell (Count), Cell (Rate), and Cell (Second). Pressing the measurement start button (Go button) displays the alarm/error measurement results on the Alarm/Error panel. To display the current result, select Current; to display the final result, select Last.

Performs the above 1 to 3 operations with the following physical interface settings :

Bitrate : 45M-M23 : On, PLCP : On or Off
 45M-Cbit : On, PLCP : Off
 1.5M-ESF : On, PLCP : On or Off

SECTION 7 MAINTENANCE

7.1 Daily Maintenance

1. To remove contaminants, wipe the unit with a cloth moistened with detergent.
2. To remove dirt and dust, vacuum the unit.
3. Tighten the screws on the parts with the specified tool.

7.2 Storage

Note the following when storing the unit for a long time:

1. Remove dust and contaminants before storing the unit.
2. Store the unit in a place where the temperature is between -20°C and 60°C .
3. Do not store the unit in a place for a long time where there is direct sunlight or much dust.
4. Do not store the unit in a place for a long time where there is a possibility that the unit is exposed to water or active gas.
5. Do not store the unit in a place where the unit may be oxidized or there is vibration.

7.3 Transportation

If you have the transportation pads that came with the unit, use them to pack the unit: otherwise, follow the instructions given below. To avoid damage to the unit, put on clean gloves and gently pack the unit.

1. Clean the unit with a dry cloth to remove contaminants or dust.
2. Check for loose or lost screws.
3. Use protective pads on projected or fragile parts. Wrap the unit with a polyethylene sheet. Then, pack it using a humidity-protective paper.
4. Put the packed unit in a corrugated cardboard box, and close the box with a tape. Store the unit in a wooden box as necessary.

7.4 Calibration

The unit is calibrated only by the manufacturer. For highest performance, calibrate the unit regularly.

APPENDIX

APPENDIX A PERFORMANCE TEST RESULT SHEET

Unit name : MU120010A T1/T3 unit Report No. : _____
 Serial No : _____ Test engineer : _____
 Test location : _____ Ambient temperature : _____ °C
 Date : ___year___month___day (___) Relative humidity : _____ %
 Notice : _____

Alarm/error measurement test

Item	Standard	Test result	Result
Code	0 [Count]		
CRC-6	0 [Count]		
CP	0 [Count]		
FEBE	0 [Count]		
PLCP-BIP-8	0 [Count]		
PLCP-FEBE	0 [Count]		
LOS	0 [s]		
OOF	0 [s]		
AIS	0 [s]		
Yellow	0 [s]		
Idle	0 [s]		
PLCP-OOF	0 [s]		
PLCP-Yellow	0 [s]		
LCD	0 [s]		
Corrected	0 [Count]		
Discarded	0 [Count]		

APPENDIX A PERFORMANCE TEST RESULT SHEET

INDEX

B

BNC 1-6, 3-1

C

Corrected cell 1-1

D

DSX 1-1, 4-6, 6-2

Discarded cell 1-3

H

HEC 1-1, 1-5, 4-8, 4-10, 4-14

L

Live-Monitor measurement 4-3

M

MU1220A ATM Quality Analyzer I, 1-1

MU120010A T1/T3 Unit ii, I, 1-1, 1-6, 1

MU120020A QoS Unit 1-1, 4-3, 4-12

MU120021A Protocol Unit 1-1, 4-3, 4-12

R

Reception loopback 1-1, 4-4

T

Transmission loopback 1-1, 4-4

INDEX