

**MU120015A ATM25M Unit
MU120016A 6.3M Unit
MU120017A 6.3/25M Unit
Operation Manual**

Sixth Edition

**Read this manual before using the equipment.
Keep this manual with the equipment.**

ANRITSU CORPORATION

Safety Symbols

To prevent the risk of personal injury or loss related to equipment malfunction, Anritsu Corporation uses the following safety symbols to indicate safety-related information. Insure that you clearly understand the meanings of the symbols BEFORE using the equipment. Some or all of the following five symbols may not be used on all Anritsu equipment. In addition, there may be other labels attached to products which are not shown in the diagrams in this manual.

Symbols used in manual

DANGER  This indicates a very dangerous procedure that could result in serious injury or death if not performed properly.

WARNING  This indicates a hazardous procedure that could result in serious injury or death if not performed properly.

CAUTION  This indicates a hazardous procedure or danger that could result in light-to-severe injury, or loss related to equipment malfunction, if proper precautions are not taken.

Safety Symbols Used on Equipment and in Manual

The following safety symbols are used inside or on the equipment near operation locations to provide information about safety items and operation precautions. Insure that you clearly understand the meanings of the symbols and take the necessary precautions BEFORE using the equipment.



This indicates a prohibited operation. The prohibited operation is indicated symbolically in or near the barred circle.



This indicates an obligatory safety precaution. The obligatory operation is indicated symbolically in or near the circle.



This indicates warning or caution. The contents are indicated symbolically in or near the triangle.



This indicates a note. The contents are described in the box.



These indicate that the marked part should be recycled.

MU120015A ATM25M Unit

MU120016A 6.3M Unit

MU120017A 6.3/25M Unit

Operation Manual

10 February 1998 (First Edition)

21 September 2004 (Sixth Edition)

Copyright © 1998-2004, ANRITSU CORPORATION.

All rights reserved. No part of this manual may be reproduced without the prior written permission of the publisher.

The contents of this manual may be changed without prior notice.

Printed in Japan

For Safety

WARNING



or



Repair

WARNING 

1. ALWAYS refer to the operation manual when working near locations at which the alert mark shown on the left is attached. If the operation, etc., is performed without heeding the advice in the operation manual, there is a risk of personal injury. In addition, the equipment performance may be reduced. Moreover, this alert mark is sometimes used with other marks and descriptions indicating other dangers.
2. When supplying power to this equipment, connect the accessory 3-pin power cord to a grounded outlet. If a grounded outlet is not available, before supplying power to the equipment, use a conversion adapter and ground the green wire, or connect the frame ground on the rear panel of the equipment to ground. If power is supplied without grounding the equipment, there is a risk of receiving a severe or fatal electric shock.
3. This equipment cannot be repaired by the user. DO NOT attempt to open the cabinet or to disassemble internal parts. Only Anritsu-trained service personnel or staff from your sales representative with a knowledge of electrical fire and shock hazards should service this equipment. There are high-voltage parts in this equipment presenting a risk of severe injury or fatal electric shock to untrained personnel. In addition, there is a risk of damage to precision parts.

For Safety

CAUTION

Check Terminal



1. Never input a signal of more than the indicated value between the measured terminal and ground. Input of an excessive signal may damage the equipment.
-

Equipment Certificate

Anritsu Corporation certifies that this equipment was tested before shipment using calibrated measuring instruments with direct traceability to public testing organizations recognized by national research laboratories including the National Institute of Advanced Industrial Science and Technology, and the National Institute of Information and Communications Technology, and was found to meet the published specifications.

Anritsu Warranty

Anritsu Corporation will repair this equipment free-of-charge if a malfunction occurs within 1 year after shipment due to a manufacturing fault, provided that this warranty is rendered void under any or all of the following conditions.

- The fault is outside the scope of the warranty conditions described in the operation manual.
- The fault is due to mishandling, misuse, or unauthorized modification or repair of the equipment by the customer.
- The fault is due to severe usage clearly exceeding normal usage.
- The fault is due to improper or insufficient maintenance by the customer.
- The fault is due to natural disaster including fire, flooding, earthquake, etc.
- The fault is due to use of non-specified peripheral equipment, peripheral parts, consumables, etc.
- The fault is due to use of a non-specified power supply or in a non-specified installation location.

In addition, this warranty is valid only for the original equipment purchaser. It is not transferable if the equipment is resold.

Anritsu Corporation will not accept liability for equipment faults due to unforeseen and unusual circumstances, nor for faults due to mishandling by the customer.

Anritsu Corporation Contact

If this equipment develops a fault, contact Anritsu Service and Sales offices at the address at the end of paper-edition manual or the separate file of CD-edition manual.

CE Conformity marking

Anritsu affixes the CE Conformity marking on the following product (s) in accordance with the Council Directive 93/68/EEC to indicate that they conform to the EMC and LVD directive of the European Union (EU).

CE marking



1. Product Model

Plug-in Units: MU120015A ATM25M Unit,
MU120016A 6.3M Unit,
MU120017A 6.3/25M Unit

2. Applied Directive and Standards

When the MU120015A ATM25M Unit, MU120016A 6.3M Unit, and MU120017A 6.3/25M Unit are installed in the MP1220A, the applied directive and standards of this Unit are conformed to those of the MP1220A main frame.

PS: About main frame

The kind of main frame (a measuring apparatus) will be to increase.
Please, contact us about the newest information of the main frame.

C-tick Conformity marking

Anritsu affixes the C-tick marking on the following product (s) in accordance with the regulation to indicate that they conform to the EMC framework of Australia/New Zealand.

C-tick marking



1. Product Model

Plug-in Units: MU120015A ATM25M Unit,
MU120016A 6.3M Unit,
MU120017A 6.3/25M Unit

2. Applied Directive and Standards

When the MU120015A ATM25M Unit, MU120016A 6.3M Unit, and MU120017A 6.3/25M Unit are installed in the MP1220A, the applied directive and standards of this Unit are conformed to those of the MP1220A main frame.

PS: About main frame

The kind of main frame (a measuring apparatus) will be to increase.
Please, contact us about the newest information of the main frame.

Preface

Organization of the Operation Manual

MU120015A ATM25M Interface Unit, MU120016A 6.3M Interface unit and MU120017A 6.3/25M Interface Unit is one of the plug-in units which can be inserted to the MP1220A ATM Quality Analyzer. Manuals are provided for the mainframe and each of the plug-in units. Each manual is supplemented with a remote control instruction manual (the remote control software is optional). Select and use the manuals that meet your needs

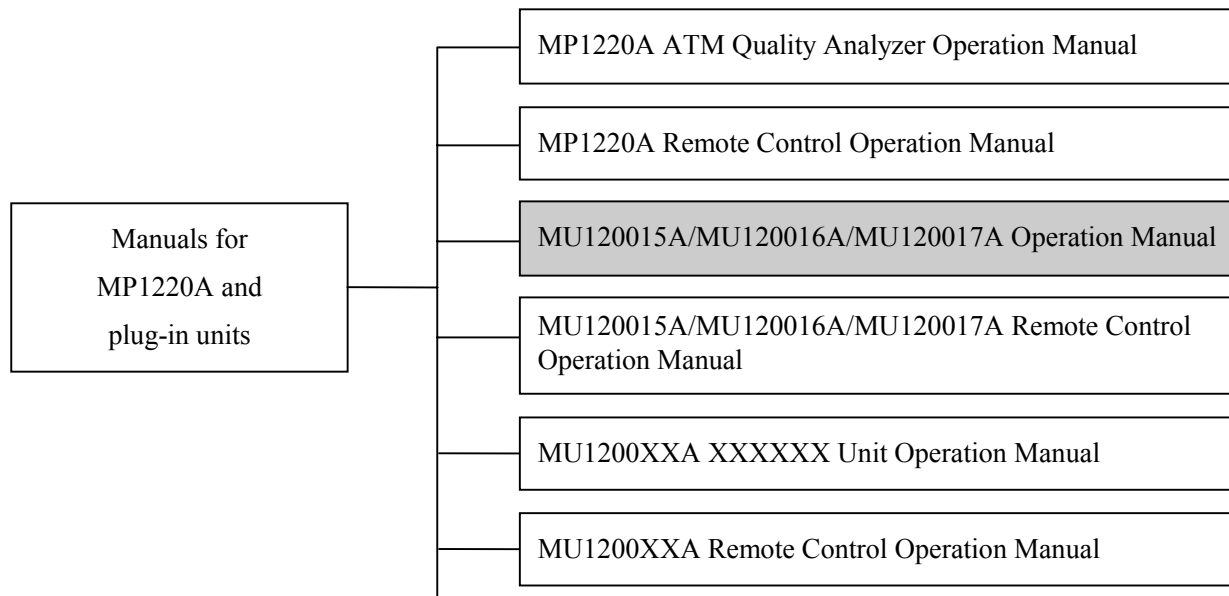

- **MP1220A ATM Quality Analyzer Operation Manual**
Provides an overview of the MP1220A and describes its usage precautions, panel configuration, specifications, performance, and operation.
- **MP1220A ATM Quality Analyzer Remote Control Operation Manual**
Describes how to control the equipment through an external interface, and provides program examples.
- **Operation Manuals for each unit**
Provides an overview of each unit and describes its specifications, performance and operation.
- **Operation Manuals for each unit's remote control units**
Describes how to control the unit through an external interface, and provides programs examples.

Contents

For Safety	iii
Preface	I
Section 1 Overview	1-1
1.1 Overview of the Product	1-1
1.2 Specifications	1-2
1.3 Configuration	1-9
1.3.1 Standard Configuration	1-9
1.3.2 Application Parts	1-9
Section 2 Preparation For Use	2-1
2.1 Environmental Requirements	2-1
2.2 Safety Precautions	2-2
Section 3 Description Of The Panel	3-1
3.1 Organization of the Panel and Its Functions	3-1
Section 4 Description Of The Screen	4-1
4.1 MU120017A 6/25M UNIT Window	4-1
4.2 Construction panel	4-2
4.2.1 Physical Interface Setup Dialog Box	4-4
4.2.2 Search Condition Setup Dialog Box	4-6
4.3 Tx-Setup Panel	4-7
4.3.1 Tc Setup Dialog Box	4-8
4.3.1.1 Byte Setup dialog box	4-10
4.3.2 Alarm/Error Setup Dialog Box	4-11
4.4 Rx-Setup Panel	4-13
4.4.1 Tc Setup Dialog Box	4-14
4.4.2 Trigger Setup Dialog Box	4-15
4.5 Alarm/Error Panel	4-16
4.5.1 Layout Dialog Box	4-17

4.6 Analyze Panel	4-18
4.6.1 Jump Dialog Box	4-19
4.6.2 Analyze Setup Dialog Box	4-20
Section 5 Measurement	5-1
5.1 Performance Measurement	5-1
Section 6 Performance Test	6-1
6.1 About Performance Tests	6-1
6.1.1 Alarm/Error Measurement Test	6-2
Section 7 Maintenance	7-1
7.1 Daily Maintenance	7-1
7.2 Notes on Storage	7-2
7.3 Transportation	7-3
7.4 Calibration	7-4
Appendix	A-1
Index	I-1

Section 1 Overview

1.1 Overview of the Product

MU120017A 6.3/25M UNIT, which is to be inserted to a slot of the MP1220A ATM Quality Analyzer (Main frame), adds frame to or terminates the 6.312Mb/s and 25.6Mb/s signal, and gains HEC synchronization to the signal.

MU120015A ATM25M UNIT (25M Unit) adds frame to or terminates the 25.6Mb/s signal, and the MU120016A 6.3M Unit (6.3M Unit) adds frame to or terminates the 6.312Mb/s signal and gains HEC synchronization to the signal.

Note that this operation manual is written for MU120017A 6.3/25M UNIT (referred to as THIS UNIT). Hence, the user of ATM25M unit can ignore the description about 6.312Mb/s signal handling, and the user of 6.3M unit can ignore the description about 25.6Mb/s signal.

Features

- Capable of receiving monitor level signal (attenuated by 20dB. Only for 6.3M).
- Loopback function
 - Reception loopback (the received signal, as well as being measured by this unit, is folded back inside the unit to the transmitter side, and is sent to the external terminals, MU120020A QoS unit, and MU120021A protocol unit)
 - Transmission loopback (the transmission signal, as well as sent to the external terminal, is redirected to the receiver side inside the unit).
- Error/Alarm measurement
 - Various types of error/Alarms including error ratios, error count, error status display, and warning status display.
- Cell number count by HEC function
 - Number of cells disposed due to header error.
 - Number of cells whose header are error corrected (6.3M signal only).

1.2 Specifications

Table 1-1 shows specifications for MU120017A 6M/25M unit.

Table 1-1 Specifications for MU120017A 6M/25M unit

Number	Item	Specification																											
1 1.1	Input/output 25M Output/Input Transmission bit rate Output waveform Reception bit rate Input level Connector Code	32.00Mb/s ± 10ppm (when used with the internal clock) Compliant with af-phy-0040.000 (ATM-Forum) 32.00Mb/s ± 100ppm Can be received the transmission signal. 8-pin modular 100 Ω NRZI(4B/5B)																											
1.2	6.3M Output Transmission bit rate Output waveform Connector Code	6.312Mb/s ± 10ppm (when used with the internal clock) Compliant with NTT specification 5597-10 BNC75 Ω B8ZS																											
1.3	6.3M Input Reception bit rate Input level Connector Code	6.312Mb/s ± 30ppm 2Vo-p ± 0.3V + 0 to 6dB cable loss while monitoring, 0.2Vo-p ± 0.03V + 0 to 6dB cable loss BNC75 Ω B8ZS																											
1.4	25M Connector change	<table border="1"> <thead> <tr> <th>Pin number</th> <th>→ NT</th> <th>→ TE</th> </tr> </thead> <tbody> <tr> <td>1</td> <td>Transmission +</td> <td>Reception +</td> </tr> <tr> <td>2</td> <td>Transmission -</td> <td>Reception -</td> </tr> <tr> <td>3</td> <td>Non-connection</td> <td>Non-connection</td> </tr> <tr> <td>4</td> <td>Non-connection</td> <td>Non-connection</td> </tr> <tr> <td>5</td> <td>Non-connection</td> <td>Non-connection</td> </tr> <tr> <td>6</td> <td>Non-connection</td> <td>Non-connection</td> </tr> <tr> <td>7</td> <td>Reception +</td> <td>Transmission +</td> </tr> <tr> <td>8</td> <td>Reception -</td> <td>Transmission -</td> </tr> </tbody> </table>	Pin number	→ NT	→ TE	1	Transmission +	Reception +	2	Transmission -	Reception -	3	Non-connection	Non-connection	4	Non-connection	Non-connection	5	Non-connection	Non-connection	6	Non-connection	Non-connection	7	Reception +	Transmission +	8	Reception -	Transmission -
Pin number	→ NT	→ TE																											
1	Transmission +	Reception +																											
2	Transmission -	Reception -																											
3	Non-connection	Non-connection																											
4	Non-connection	Non-connection																											
5	Non-connection	Non-connection																											
6	Non-connection	Non-connection																											
7	Reception +	Transmission +																											
8	Reception -	Transmission -																											
1.5	Ext clk Input Frequency Level Connector	6M : 6.312Mb/s ± 30ppm (rectangular wave only) 25M : 32.00Mb/s ± 100ppm (rectangular wave only) 0.6 to 1.2Vp-p BNC50 Ω																											

Number	Item	Specification
1.6	Rev clk Output Frequency Level Connector	6M : 6.312Mb/s (Duty: $50 \pm 20\%$, \pm ppm range varies depending on the incoming frequency) 25M : 32.00Mb/s (Duty: $50 \pm 20\%$, \pm ppm range varies depending on the incoming frequency) 0.7 to 1.0Vp-p (Input and Output are mutually independent. Duty ratio is $50 \pm 20\%$ while the received signal is looped back to transmission stage) BNC50 Ω
1.7	Trig Output Level Connector	TTL level (triggered by Low level) BNC50 Ω
2	Operation mode	
2.1	Measurement mode	Input and output are mutually independent. The reception signal is looped back to transmission stage. The transmission signal is looped back to reception stage inside the unit.
2.2	Unit through function Transmission through Reception through	The cell from the lower unit can be passed through the upper unit. The cell from the upper unit can be passed through the lower unit.
3	Transmission function	
3.1	Network type	UNI/NNI
3.2	Clock type	Internal, External, Received
3.3	TC function Transmission free cell setting Transmission scramble cell Transmission coset processing	(6.3M only) GFC, PT, CLP, HEC, and Payload (48 bite are same value as bite unit.) ON/OFF (6.3M only) ON/OFF
3.4	Error addition Type Timing Burst Error mask	Bit, CRC5, Code, Cell error Single, 1×10^{-n} (n=3,4,5,6,7,8,9), ALL Note: n=3, 4, 5, 6 only when Cell is selected. Only Single can be used when Code is selected 1 to 64 (effective only for cell errors) Bit mask specified (effective only for cell errors)
3.5	Alarm addition Type Timing	LOS, AIS, RAI, LOF, LCD ALL

Number	Item	Specification
4	Reception function	
4.1	Network type	UNI/NNI
4.2	1023ch Measurement function Setting	Type selection : VP or VC Default channel : ON/OFF Channel number : 1 to 1023 Setting channel search time : 5 to 99sec (1 second unit) 1 to 99 min (1 minute unit)
4.3	TC function Cell de-scramble Coset processing HEC error correction	ON/OFF (6.3M only) ON/OFF ON/OFF (6.3M only)
4.4	Monitor level	ON/OFF (6.3M only)
4.5	Error detection Type Display	6.3M : CRC5, Corrected Cell, Discarded Cell 25M : Code, Discarded Cell, Illegal Cell Count display : 0 to 999999, 1.00E06 to 9.99E15, >9.99E15 Errors second display : 0 to 999999, 1.00E06 to 9.99E15, >9.99E15[S] Rate display : 1.00E-15 to 1.00E00, 0.00E00 to 0.00E-15, >1.00E-15 However Illegal Cell is Count display and Error second display only.
4.6	Alarm detection Type Display	LOS, AIS, RAI, LOF, LCD (LOS only when 25M is selected) However LOS is not displayed in the transmission to reception loopback. 0 to 999999, 1.00E06 To 9.99E15, >9.99E15[S]
4.7	Analyze function	Displays the detected Error/Alarm in the graph.
5	Sync-Event function Transmission Reception	(25M only) OFF, Internal 8k timing, Reception timing Now, Max, Min, Average Count display : 0 to 999999, 1.00E06 to 9.99E15, >9.99E15[count/s]
6	Trigger generation Type Port connection Trigger output Internal trigger	6.3M : LCD 25M : Sync Event, Illegal Cell ON/OFF Internal-1/Internal-2 Internal-1/Internal-2
7	Mechanical Dimensions Mass	29.5(H)×169(W)×241(D) [mm] 1.0 kg or less
8	Environmental performance	Conforms to the mainframe specifications.

Table 1-2 shows the specifications for MU120015A 25M unit.

Table 1-2 MU120015A 25M unit

Number	Item	Specification																											
1 1.1	Input/output 25M Output/Input Transmission bit rate Output waveform Reception bit rate Input level Connector Code	32.00Mb/s \pm 10ppm (For internal clock) Compliant with af-phy-0040.000 (ATM Forum) 32.00Mb/s \pm 100ppm Can be received the transmission signal 8-pins modular 100 Ω NRZI (4B/5B)																											
1.2	25M connector change	<table border="1"> <thead> <tr> <th>Pin number</th> <th>\rightarrowNT</th> <th>\rightarrowTE</th> </tr> </thead> <tbody> <tr> <td>1</td> <td>Transmission +</td> <td>Reception +</td> </tr> <tr> <td>2</td> <td>Transmission -</td> <td>Reception -</td> </tr> <tr> <td>3</td> <td>Non-connection</td> <td>Non-connection</td> </tr> <tr> <td>4</td> <td>Non-connection</td> <td>Non-connection</td> </tr> <tr> <td>5</td> <td>Non-connection</td> <td>Non-connection</td> </tr> <tr> <td>6</td> <td>Non-connection</td> <td>Non-connection</td> </tr> <tr> <td>7</td> <td>Reception +</td> <td>Transmission +</td> </tr> <tr> <td>8</td> <td>Reception -</td> <td>Transmission -</td> </tr> </tbody> </table>	Pin number	\rightarrow NT	\rightarrow TE	1	Transmission +	Reception +	2	Transmission -	Reception -	3	Non-connection	Non-connection	4	Non-connection	Non-connection	5	Non-connection	Non-connection	6	Non-connection	Non-connection	7	Reception +	Transmission +	8	Reception -	Transmission -
Pin number	\rightarrow NT	\rightarrow TE																											
1	Transmission +	Reception +																											
2	Transmission -	Reception -																											
3	Non-connection	Non-connection																											
4	Non-connection	Non-connection																											
5	Non-connection	Non-connection																											
6	Non-connection	Non-connection																											
7	Reception +	Transmission +																											
8	Reception -	Transmission -																											
1.3	Ext clk Input Frequency Level Connector	25M : 32.00Mb/s \pm 100ppm (For rectangular wave only) 0.6 to 1.2Vp-p BNC50 Ω																											
1.4	Rcv clk Output Frequency Level Connector	25M : 32.00Mb/s (Duty : 50 \pm 10%, \pm ppm depends on the incoming frequency) 0.7 to 1.0Vp-p BNC50 Ω																											
1.5	Trig Output Level Connector	TTL level (triggered by Low level) BNC50 Ω																											
2 2.1	Operation mode Measurement mode	Input and output are mutually independent. The reception signal is looped back to transmission stage. The transmission signal is looped back to reception stage inside the unit.																											
2.2	Unit trough function Transmission through Reception through	The cell from the lower unit can be passed through the upper unit. The cell from the upper unit can be passed through the lower unit.																											

Number	Item	Specification
3	Transmission function	
3.1	Network type	UNI/NNI
3.2	Clock selection	Internal, External, Received signal
3.3	TC function Transmission Coset processing	ON/OFF
3.4	Error addition Type Timing	Code Single
3.5	Alarm addition Type Timing	LOS ALL
4	Reception function	
4.1	Network type	UNI/NNI
4.2	1023ch Measurement function Setting	Type selection : VP or VC Default channel : ON/PFF Channel number : 1 to 1023 Setting channel search time : 5 to 99sec (1 second unit) 1 to 99min (1 minute unit)
4.3	TC function Coset processing	ON/OFF
4.4	Error detection Type Display	Code, Discarded, Cell, Illegal Cell Count : 0 to 999999, 1.00E06 to 9.99E15, >9.99E15 Errors/second : 0 to 999999, 1.00E06 to 9.99E15, >9.99E15[S] Rate : 1.00E-15 to 1.00E00, 0.00E00 to 0.00E-15, >1.00E-15 However Illegal Cell is Count display and Error second display only.
4.5	Alarm detection Type Display	LOS However LOS is not displayed in the transmission to reception loopback. 0 to 999999, 1.00E06 to 9.99E15, >9.99E15[S]
4.6	Analyze function	Displays the detected Error/Alarm in the graph.
5	Sync Event function Transmission Reception	Off, Internal 8k timing, Reception timing. Now, Max, Min, Average Count display: 0 to 999999, 1.00E06 to 9.99E15, >9.99E15[count/s]

Number	Item	Specification
6	Trigger generation Type Port connection Trigger output Internal trigger	Sync Event, Illegal Cell ON/OFF Internal-1/Internal-2 Internal-1/Internal-2
7	Dimensions and weight Dimensions Weight	29.5(H) × 169(W) × 241(D)[mm] 1.0kg or less

Table 1-3 shows specifications for MU120016A 6M unit

Table 1-3 MU120016A 6M unit

Number	Item	Specification
1 1.1	Input/output 6.3M Output Transmission bit rate Output waveform Connector Code	6.312Mb/s \pm 10ppm (For internal clock) Compliant with NTT specification 5597-10 BNC75 Ω B8ZS
1.2	6M Input Reception bit rate Input level Connector Code	6.312Mb/s \pm 30ppm 2V o-p \pm 0.3V, with the cable loss of 0 to 6dB While monitoring; 0.2Vo-p \pm 0.03V, with the cable loss of 0 to 6dB. BNC75 Ω B8ZS
1.3	Ext clk Input Frequency Level Connector	6M : 6.312Mb/s \pm 30ppm (For rectangular wave only) 0.6 to 1.2Vp-p BNC50 Ω
1.4	Rcv clk Output Frequency Level Connector	6M : +6.312Mb/s (Duty : 50 \pm 10%, \pm ppm depends on the incoming frequency) 0.7 to 1.0Vp-p (Input and output are mutually independent. Duty ratio is 50 \pm 10% when the received signal is looped back to transmission stage) BNC50 Ω
1.5	Trig Output Level Connector	TTL level (triggered by Low level) BNC75 Ω
2 2.1	Operation mode Measurement mode	Input and output are mutually independent. The reception signal is looped back to transmission stage. The transmission signal is looped back to reception stage inside the unit.
2.2	Unit trough function Transmission through Reception through	The cell from the lower unit can be passed through the upper unit. The cell from the upper unit can be passed through the lower unit.
3 3.1	Transmission function Network type	UNI/NNI
3.2	Clock selection	Internal, External, Received signal

Number	Item	Specification
3.3	TC function Transmission free cell setting Transmission scramble cell Transmission coset processing	GFC, PT, CLP, HEC, and Payload (48 bite are same value as bite unit.) ON/OFF ON/OFF
3.4	Error addition Type Timing Burst Error addition byte	Bit, CRC5, Cell Single, $1 \times 10\text{-}n$ ($n=3,4,5,6,7,8,9$), ALL Note : $n = 3, 4, 5, 6$ only when Cell is selected. 1 to 64 (for cell error only) 1 to 53 (1 byte unit) (for cell error only)
3.5	Alarm addition Type Timing	LOS, AIS, RAI, LOF, LCD ALL
4	Reception function	
4.1	Network type	UNI/NNI
4.2	1023ch Measurement function Setting	Type selection : VP or VC Default channel : ON/OFF Channel number : 1 to 1023 Setting channel search time : 5 to 99sec (1 second unit) 1 to 99 min (1 minute unit)
4.3	TC function Cell de-scramble Coset processing HEC error correction	ON/OFF ON/OFF ON/OFF
4.4	Monitor level	ON/OFF
4.5	Error detection Type Display	CRC5, Corrected Cell, Discarded Cell Count display : 0 to 999999, 1.00E06 to 9.99E15, >9.99E15 Errors second display : 0 to 999999, 1.00E06 to 9.99E15, >9.99E15[S] Rate display : 1.00E-15 to 1.00E00, 0.00E00 to 0.00E-15, >1.00E-15
4.6	Alarm detection Type Display	LOS, AIS, RAI, LOF, LCD (LOS only when 25M is selected) However LOS is not displayed in the transmission to reception loopback. 0 to 999999, 1.00E06 To 9.99E15, >9.99E15[S]
4.7	Analyze function	Displays the detected Error/Alarm in the graph.

Section 1 Overview

Number	Item	Specification
5	Trigger generation Type Port connection Trigger output Internal trigger	LCD ON/OFF Internal-1/Internal-2 Internal-1/Internal-2
6	Mechanical Dimensions Mass	29.5(H) × 169(W) × 241(D) [mm] 1.0 kg or less
7	Environmental performance	Conforms to the mainframe specifications.

1.3 Configuration

1.3.1 Standard Configuration

Table 1-4 shows the standard configuration of MU120017A 6.3/25M unit.

Table 1-4 Standard Configuration of MU120017A 6.3/25M unit

Item	Type/No.	Description	Quantity	Note
This unit	MU120017A	6.3/25M unit	1	
Documents	MW1312AE	MU120015A/MU120016A/MU120017A Operation manual	1	
	MW1318AE	MU120015A/MU120016A/MU120017A Remote control operation manual	1	

Table 1-5 shows the standard configuration of MU120015A ATM25M unit.

Table 1-5 MU120015A ATM25M unit.

Item	Type/No.	Description	Quantity	Note
ATM25M unit	MU120015A	ATM25M unit	1	
Documents	MW1312AE	MU120015A/MU120016A/MU120017A Operation manual	1	
	MW1318AE	MU120015A/MU120016A/MU120017A Remote control operation manual	1	

Table 1-6 shows the standard configuration of the MU120016A 6.3M unit.

Table 1-6 MU120016A 6.3M unit.

Item	Type/No.	Description	Quantity	Note
6M unit	MU120016A	6.3M unit	1	
Documents	MW1312AE	MU120015A/MU120016A/MU120017A Operation manual	1	
	MW1318AE	MU120015A/MU120016A/MU120017A Remote control operation manual	1	

1.3.2 Application Parts

Table 1-7 shows the application parts of the MU120017A 6.3/25M UNIT.

Table 1-7 Application Parts of MU120017A 6.3/25M UNIT

Type/No.	Description	Quantity
J0775D	75 Ω coaxial cable (2 m) : terminated with BNC 75 Ω connector on both ends.	1
J0776D	50 Ω coaxial cable (2 m) : terminated with BNC 50 Ω connector on both ends.	1
J0838A	UTP category 3 cable	1

Table 1-8 shows the application parts of MU120015A ATM25M UNIT.

Table 1-8 Application Parts of he MU120015A ATM25M UNIT

Type/No.	Description	Quantity
J0775D	75 Ω coaxial cable (2 m) : terminated with BNC 75 Ω connector on both ends.	1
J0776D	50 Ω coaxial cable (2 m) : terminated with BNC 50 Ω connector on both ends.	1
J0838A	UTP category 3 cable	1

Table 1-9 shows the application parts of the MU120016A 6.3M unit.

Table 1-9 Application Parts of MU120016A 6.3M UNIT

Type/No.	Description	Quantity
J0775D	75 Ω coaxial cable (2 m) : terminated with BNC 75 Ω connector on both ends.	1
J0776D	50 Ω coaxial cable (2 m) : terminated with BNC 50 Ω connector on both ends.	1

Section 2 Preparation For Use

2.1 Environmental Requirements

Avoid using this instrument in the environment described below:

1. Places where temperature rises above 50°C or falls below 5°C, or where humidity exceeds 85% or falls short of 45%.
2. Places where the sun may hit the unit directly, or dust may accumulate inside the unit.
3. Places exposed to direct sunlight or dusty place.
4. Places where the unit is exposed to oxidation or strong vibration.

2.2 Safety Precautions

- Never attempt to insert the unit into the instruments other than the MP1220A ATM Quality Analyzer. The unit is designed for use solely with the MP1220A, and any attempt to use with other instruments may cause irreversible damage or hazards.

- Carefully avoid to apply higher voltage signal than rated value for this unit. This may cause circuit disruption.

- If the unit have been stored at a low temperature for a period of time, take enough length of time for the unit to equilibrate with ambient temperature and get thoroughly dry. Dew formation due to the lack of temperature equilibrium may cause short circuit.

- To avoid hazards due to static discharge, be sure to connect, prior to connecting input signals, ground lines of the instruments (including experimental ones) to be connected to the unit.

- Core and outer conductor of a coaxial cable tends to accumulate charge as a capacitor: Try to discharge using a metal rod or the like prior to use.

Section 3 Description Of The Panel

3.1 Organization of the Panel and Its Functions

Fig. 3-1 shows the front panel of the MU120017A 6.3/25M unit, and Table 3-1 describes its functions.

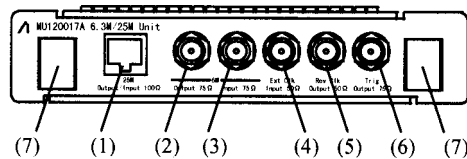

Fig. 3-1 Front panel of MU120017A 6.3/25M UNIT

Table 3-1 Description of MU120017A 6.3/25M UNIT Front Panel

No.	Label	Description																											
(1)	25M Output/Input 100 Ω	25M Input/output connector <table border="1" style="margin-left: 20px;"> <thead> <tr> <th>Pin No.</th> <th>→NT</th> <th>→TE</th> </tr> </thead> <tbody> <tr> <td>1</td> <td>Transmission +</td> <td>Reception +</td> </tr> <tr> <td>2</td> <td>Transmission -</td> <td>Reception -</td> </tr> <tr> <td>3</td> <td>Not connected</td> <td>Not connected</td> </tr> <tr> <td>4</td> <td>Not connected</td> <td>Not connected</td> </tr> <tr> <td>5</td> <td>Not connected</td> <td>Not connected</td> </tr> <tr> <td>6</td> <td>Not connected</td> <td>Not connected</td> </tr> <tr> <td>7</td> <td>Reception +</td> <td>Transmission +</td> </tr> <tr> <td>8</td> <td>Reception -</td> <td>Transmission -</td> </tr> </tbody> </table>	Pin No.	→NT	→TE	1	Transmission +	Reception +	2	Transmission -	Reception -	3	Not connected	Not connected	4	Not connected	Not connected	5	Not connected	Not connected	6	Not connected	Not connected	7	Reception +	Transmission +	8	Reception -	Transmission -
Pin No.	→NT	→TE																											
1	Transmission +	Reception +																											
2	Transmission -	Reception -																											
3	Not connected	Not connected																											
4	Not connected	Not connected																											
5	Not connected	Not connected																											
6	Not connected	Not connected																											
7	Reception +	Transmission +																											
8	Reception -	Transmission -																											
(2)	6.3M Output 75 Ω	6.3M output connector (BNC)																											
(3)	6.3M Input 75 Ω	6.3M input connector (BNC)																											
(4)	Ext Clk Input 50 Ω	External clock input connector (BNC)																											
(5)	Rev Clk Output 50 Ω	Received clock output connector (BNC)																											
(6)	Trig Output 75 Ω	Trigger output connector (BNC)																											
(7)	(Ejector)	Ejector for unit's extraction																											

Section 3 Description Of The Panel

Section 4 Description Of The Screen

4.1 MU120017A 6/25M UNIT Window

MU120017A 6/25M UNIT windows is used to specify all the settings and to display measurement results. The window is invoked from the tool bar of the MP1220A ATM Quality Analyzer window. For further information, refer to the MP1220A ATM Quality Analyzer Operation Manual.

MU120017A 6/25M UNIT window consists of the following panels.

Table 4-1 Panels in the Window

Panel	Main purpose
Construction panel	Sets up for transmitter/receiver interfaces
Tx-Setup panel	Sets up for transmitter
Rx-Setup panel	Sets up for Receiver
Alarm/Error panel	Displays the results of alarm/Error measurements
Analyze panel	Displays history of alarm/error measurements. But, this panel is only displayed when the Logging of Measurement-1 panel is set ON in Mainframe window. (Refer to the MP1220A ATM Quality Analyzer Operation Manual)

Fig. 4-1 shows the MU120017A 6/25M UNIT window.

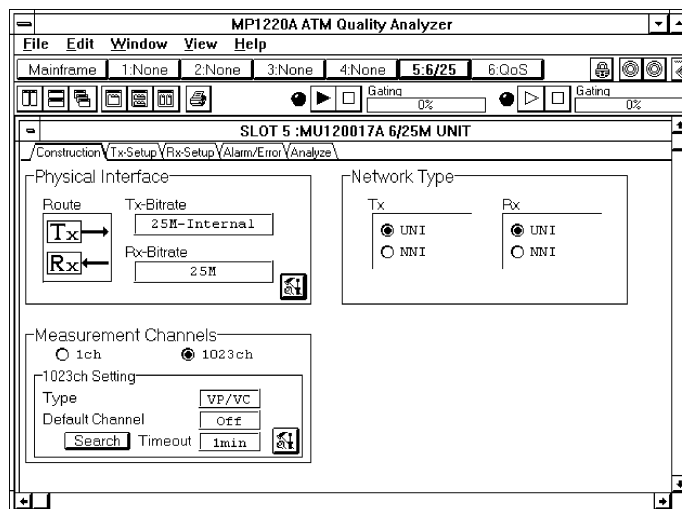

Fig. 4-1 MU120017A 6/25M UNIT Window

4.2 Construction Panel

Fig. 4-2 shows the Construction panel, and Table 4-2 describes its functions.

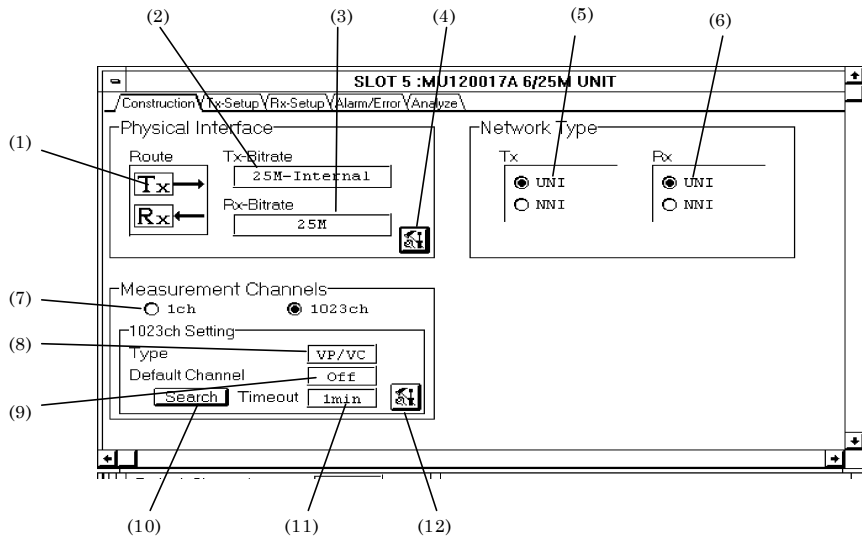



Fig. 4-2 Construction Panel

Table 4-2 Description of Construction Panel

Number	Item	Description
(1)	Route	Displays signal flow inside the unit
(2)	Tx-Bitrate	Displays the bit rate and type of clock in the transmission unit.
(3)	Rx-Bitrate	Displays the bit rate in the reception unit.
(4)		Opens Physical Interface Setup dialog box
(5)	Tx	Network type of the transmitter
(6)	Rx	Network type of the receiver
(7)	Measurement Channels	<p>Sets the monitor of the band width of each channel and AIS/RDI status in ATM network. (Live-Monitor measurement)</p> <p>The MU120020A QoS Unit and MU120021A Protocol Unit are needed for selecting “1023ch” of the Live-Monitor measurement.</p> <p>1ch : Selects the monitor for 1ch.</p> <p>1023ch : Selects the monitor for 2ch to 1023ch at the same time.</p> <p>When set “1023ch” at “Repeat” in measurement mode, the warning dialog box appears and the setting returns to “1ch”.</p>
(8)	Type	Displays the types of 1023ch measurement compatible channels.
(9)	Default Channel	Displays if the Default Channel settings are activated.
(10)	Search	If the button is pushed, 1023ch search is started.
(11)	Time Out	Displays the timeout for 1023ch search.
(12)		Opens the Search Condition Setup dialog box. Cannot be set up during measurements.

4.2.1 Physical Interface Setup Dialog Box

Fig. 4-3 shows the Physical Interface Setup dialog box, and Table 4-3 describes its functions.

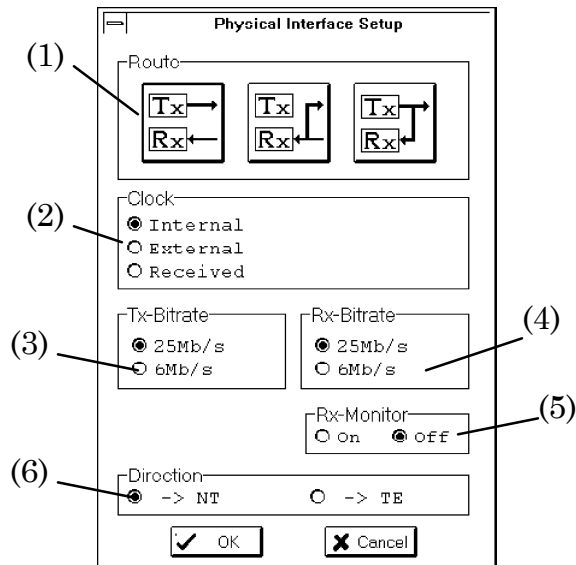
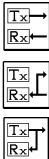





Fig. 4-3 Physical Interface Setup Dialog Box

Table 4-3 Description of Physical Interface Setup Dialog Box

Number	Item	Description																											
(1)	Route	<p>Selects a signal flow inside the unit.</p>  <p>  : Transmitter and Receiver function independently.  : Receiver loop back  : Transmitter loop back </p>																											
(2)	Clock	<p>Selects type of the working clock.</p> <p>Internal : Uses the internally generated clock.</p> <p>External : Uses the clock provided through the external connector.</p> <p>Received : Uses the clock regenerated from the received data.</p>																											
(3)	Tx-Bitrate	Sets up transmitter speed																											
(4)	Rx-Bitrate	Sets up receiver speed																											
(5)	Rx-Monitor	<p>Selects input level of received signal. Cannot be specified if Tx monitor is selected in (1), or 25M is selected in (4).</p> <p>On : Signal from the Monitor Point is connected, where the instrument's output signal is attenuated by 20dB.</p> <p>Off : The instrument's output is directly connected.</p>																											
(6)	Direction	<p>Selects the destination of 25M signal. This item cannot be specified if 6Mb/s is selected in both 4.2.1(3) and (4). The selection of this item affects pin assignment of the 25M Output/Input connector (100Ω) as shown below:</p> <table border="1" data-bbox="662 1218 1292 1543"> <thead> <tr> <th>Pin No.</th> <th>→NT</th> <th>→TE</th> </tr> </thead> <tbody> <tr> <td>1</td> <td>Transmission +</td> <td>Reception +</td> </tr> <tr> <td>2</td> <td>Transmission -</td> <td>Reception -</td> </tr> <tr> <td>3</td> <td>Not connected</td> <td>Not connected</td> </tr> <tr> <td>4</td> <td>Not connected</td> <td>Not connected</td> </tr> <tr> <td>5</td> <td>Not connected</td> <td>Not connected</td> </tr> <tr> <td>6</td> <td>Not connected</td> <td>Not connected</td> </tr> <tr> <td>7</td> <td>Reception +</td> <td>Transmission +</td> </tr> <tr> <td>8</td> <td>Reception -</td> <td>Transmission -</td> </tr> </tbody> </table>	Pin No.	→NT	→TE	1	Transmission +	Reception +	2	Transmission -	Reception -	3	Not connected	Not connected	4	Not connected	Not connected	5	Not connected	Not connected	6	Not connected	Not connected	7	Reception +	Transmission +	8	Reception -	Transmission -
Pin No.	→NT	→TE																											
1	Transmission +	Reception +																											
2	Transmission -	Reception -																											
3	Not connected	Not connected																											
4	Not connected	Not connected																											
5	Not connected	Not connected																											
6	Not connected	Not connected																											
7	Reception +	Transmission +																											
8	Reception -	Transmission -																											

4.2.2 Search Condition Setup Dialog Box

Fig. 4-4 shows the Search Condition Setup dialog box, and Table 4-4 describes its functions.

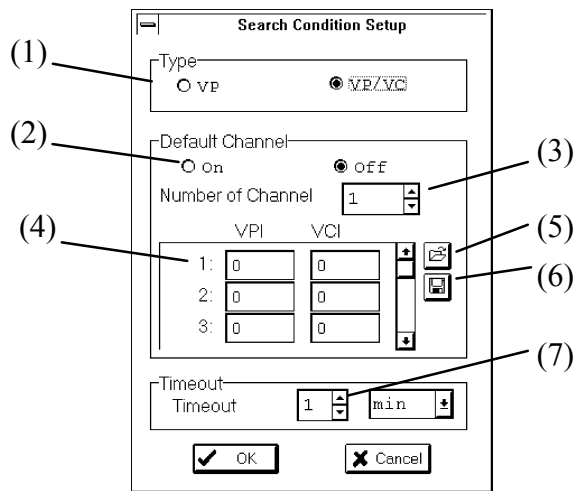



Fig. 4-4 Search Condition Setup Dialog Box

Table 4-4 Description of Search Condition Setup Dialog Box

Number	Item	Description
(1)	Type	Selects types of cells to search.
(2)	Default Channel	Selects if Default Channel settings are activated.
(3)	Number of Channel	Specifies the number of channels to search.
(4)		Specifies the values for VPI and VCI.
(5)		Reads Default Channel settings from a file.
(6)		Saves Default Channel settings to a file.
(7)	Time Out	Specifies time out for 1023ch search.

4.3 Tx-Setup Panel

Fig. 4-5 shows the Tx-Setup panel, and Table 4-5 describes its functions.

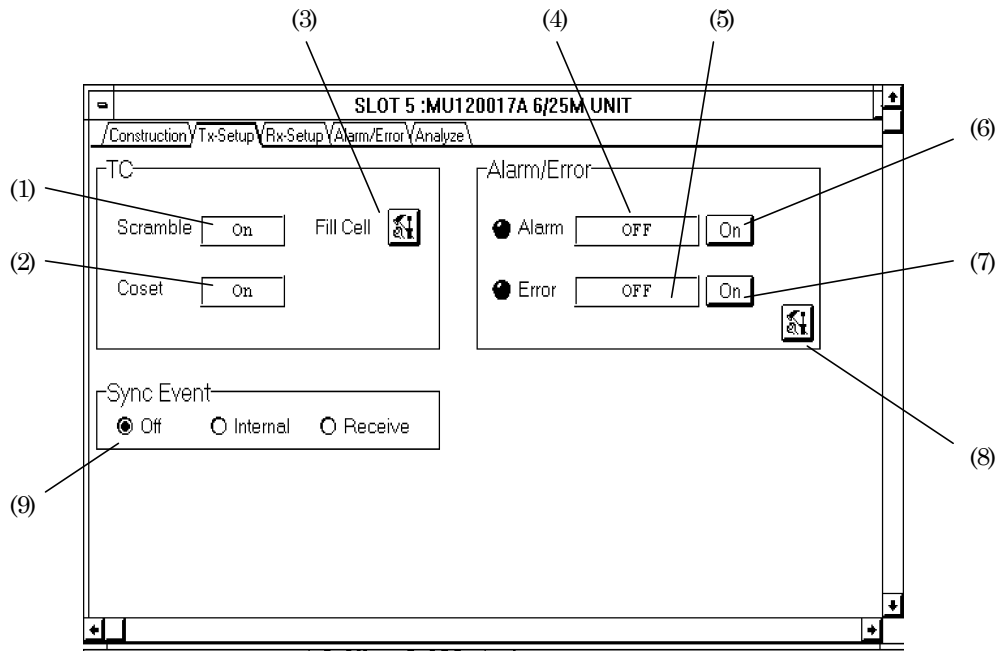



Fig. 4-5 Tx-Setup Panel

Table 4-5 Description of Tx-Setup Panel

Number	Item	Description
(1)	Scramble	Displays ON/OFF setting of scramble processing for transmitter cell payload.
(2)	Coset	Displays ON/OFF setting of Coset processing for transmitter cell HEC.
(3)	Fill Cell 	Opens Tc Setup dialog box.
(4)	Alarm	Displays the currently selected alarm type.
(5)	Error	Displays the currently selected error type.
(6)	On/Off	Adds the alarm shown in (4).
(7)	On/Off	Adds the error shown in (5).
(8)		Opens Alarm/Error/Pointer Setup dialog box.
(9)	Sync Event	Selects Sync Event setting. This item cannot be specified if 6Mb/s is selected in 4.2.1 (3).

4.3.1 Tc Setup Dialog Box

Fig. 4-6 shows the Tc Setup dialog box, and Table 4-6 describes its functions.

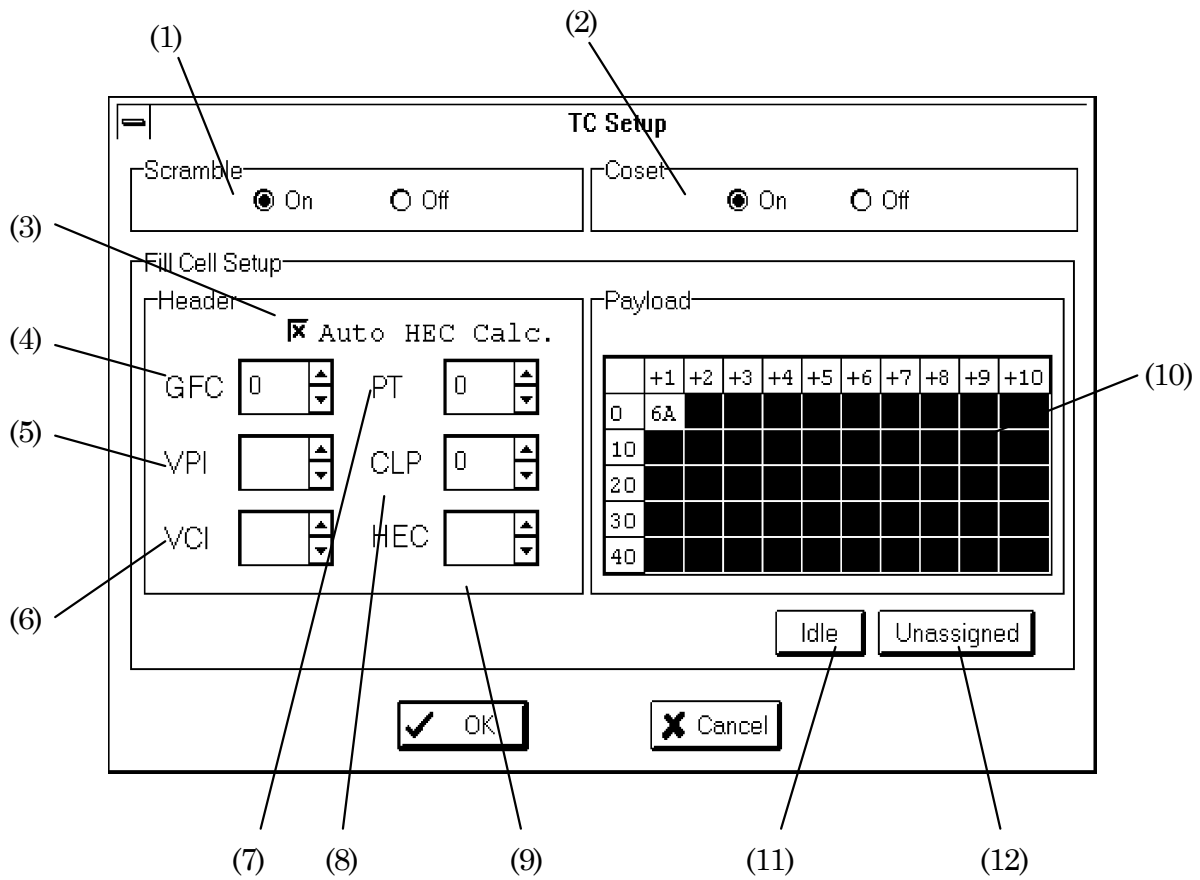

Fig. 4-6 Tc Setup Dialog Box

Table 4-6 Description of Tc Setup Dialog Box

Number	Item	Description
(1)	Scramble	Selects ON/OFF setting of scramble processing for transmitter cell payload.
(2)	Coset	Selects ON/OFF setting of Coset processing for transmitter cell HEC.
(3)	Auto HEC Calc.	Selects if HEC is automatically calculated and added.
(4)	GFC	Selects the GFC value. The GFC value cannot be specified if NNI is selected in 4.2 (5).
(5)	VPI	Displays the VPI value (fixed to be zero).
(6)	VCI	Displays the VCI value (fixed to be zero).
(7)	PT	Specifies the PT value.
(8)	CLP	Specifies the CLP value.
(9)	HEC	Specifies the HEC value. HEC value cannot be specified if Auto HEC calc. is selected in (1).
(10)	Payload	Specifies the payload value. Double click on the frame of crossing the vertical position 0 and horizontal position +1, then Byte Setup dialog box is opened.
(11)	Idle	If the button is pressed, the contents of Idle cell are shown in Header and Payload group box. The contents of the Idle cell are : GFC:0, VPI:0, VCI:0, PT:0, CLP:1, HEC : calculated value, Payload:6A.
(12)	Unassigned	If the button is pressed, the contents of Unassigned cell are shown in Header and Payload group box. The contents of the Unassigned cell are : GFC:0, VPI:0, VCI:0, PT:0, CLP:0, HEC : calculated value, Payload:6A.

4.3.1.1 Byte Setup dialog box

Fig. 4-7 shows the Byte Setup dialog box, and Table 4-7 describes its functions.

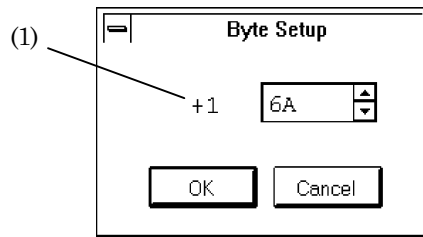

Fig. 4-7 Byte Setup Dialog Box

Table 4-7 Description of Byte Setup Dialog Box

Number	Item	Description
(1)		Specifies the payload value. 48 bytes are the same value as bite unit.

4.3.2 Alarm/Error Setup Dialog Box

4.3.2.1 Alarm Panel

Fig. 4-8 shows the Alarm panel, and Table 4-8 describes its functions.

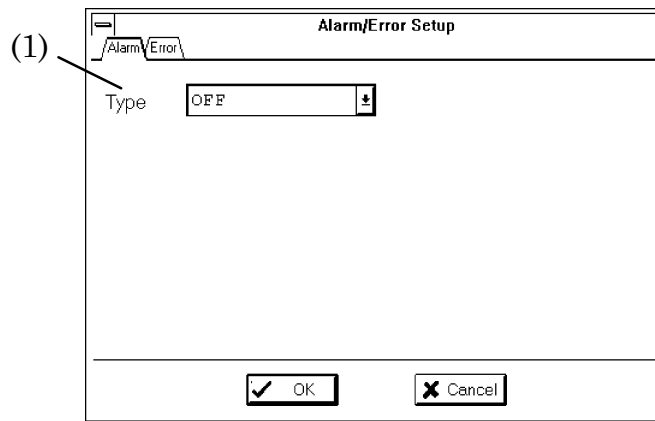

Fig. 4-8 Alarm Panel

Table 4-8 Description of Alarm Panel

Number	Item	Description
(1)	Type	Selects the type of alarms to add.

4.3.2.2 Error Panel

Fig. 4-9 shows the Error panel, and Table 4-9 describes its functions.

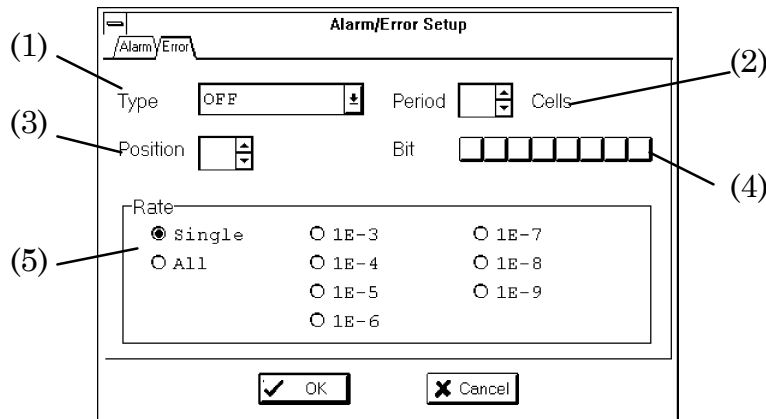

Fig. 4-9 Error Panel

Table 4-9 Description of Error Panel

Number	Item	Description
(1)	Type	Selects the type of errors to add. If Cell is selected, When Bit has been selected in the Setup screen of the MU120020A QoS Unit or MU120021A Protocol Unit, the selection of Cell will display a warning dialog and prompt user's confirmation.
(2)	Period	Specifies the number of contiguous cells to add error. Specify a desired value (1 to 64); the value can only be set if Cell is selected in (1).
(3)	Position	Specifies the byte position of the cell to be bit-reversed. The value can only be set if Cell is selected in (1).
(4)	Bit	Specifies the bit to be reversed. This selection can be made only if Cell is selected in (1).
(5)	Rate	Selects the timing of error addition. The options are: Single, All, Rate (1E-n, n=3,4,5,6,7,8,9).

4.4 Rx-Setup Panel

Fig. 4-10 shows Rx-Setup panel, and Table 4-10 describes its functions.

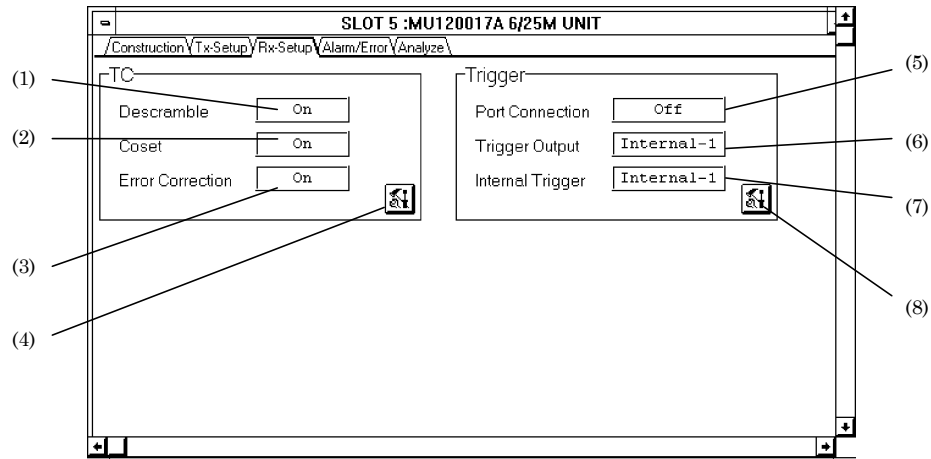



Fig. 4-10 Rx-Setup Panel

Table 4-10 Description of Rx-Setup Panel

Number	Item	Description
(1)	Descramble	Displays the setting in 4.4.1 (1).
(2)	Coset	Displays the setting in 4.4.1 (2).
(3)	Error Correction	Displays the setting in 4.4.1 (3).
(4)		Opens TC Setup dialog box.
(5)	Port Connection	Shares the trigger between units.
(6)	Trigger Output	Displays the current setting of either internal trigger is to be output to the Trigger Output connector.
(7)	Internal Trigger	Displays the current setting of either trigger is to be output to the internal trigger.
(8)		Opens the Trigger Setup dialog box.

4.4.1 Tc Setup Dialog Box

Fig. 4-11 shows the Tc Setup dialog box, and Table 4-11 describes its functions.

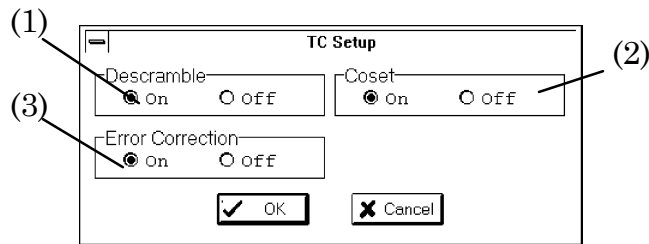

Fig. 4-11 Tc Setup Dialog Box

Table 4-11 Tc Setup Dialog Box

Number	Item	Description
(1)	Descramble	Selects ON/OFF of descrambling for receiving cell payload.
(2)	Coset	Selects ON/OFF of Coset processing for receiving cell HEC.
(3)	Error Correction	Selects ON/OFF of HEC correction for receiving cell.

4.4.2 Trigger Setup Dialog Box

Fig. 4-12 shows the Trigger Setup dialog box, and Table 4-12 describes its functions.

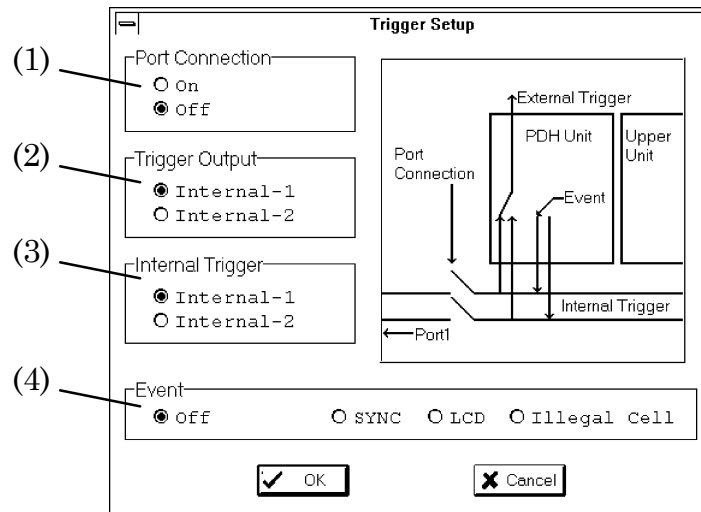

Fig. 4-12 Trigger Setup Dialog Box

Table 4-12 Description of Trigger Setup Dialog Box

Number	Item	Description
(1)	Port Connection	Trigger signal is shared in unit group when select On.
(2)	Trigger Output	Sets up the Trigger Output connector Internal-1 : Trigger line 1 trigger is connected to Trigger Output connector. Internal-2 : Trigger line 2 trigger is connected to Trigger Output connector.
(3)	Internal Trigger	Select trigger and sets up trigger line. Internal-1 : Connect trigger to the trigger line 1. Internal-2 : Connect trigger to the trigger line 2.
(4)	Event	Selects the type of trigger output.

4.5 Alarm/Error Panel

Fig. 4-13 shows the Alarm/Error panel, and Table 4-13 describes its functions.

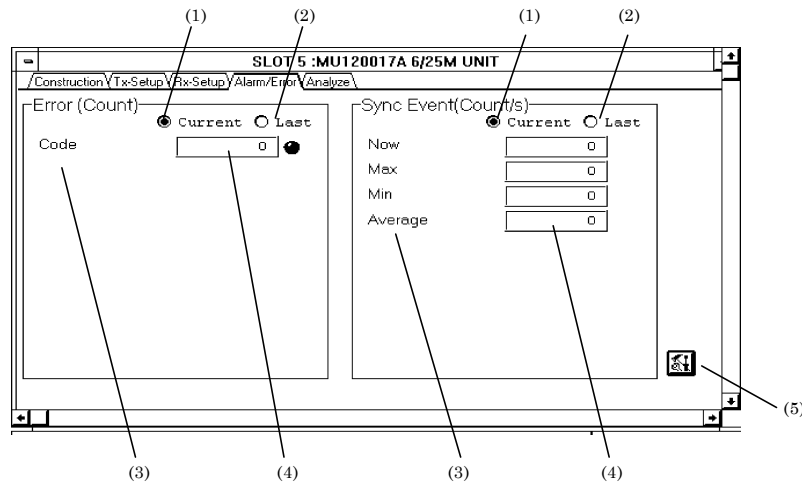



Fig. 4-13 Alarm/Error Panel

Table 4-13 Description of Alarm/Error Panel

Number	Item	Description
(1)	Current	Displays the interim results from the start to the current time.
(2)	Last	Displays the final results after the measurement is complete.
(3)		Displays all the detectable alarms, errors, and cell items concerning the specified reception bit rate and frame.
(4)	LED	Displays alarms, errors, and status of cell detection. Red : Now being detected Mandarin : Detected during a measurement (if Current is selected) Detected in the last measurement (if Last is selected)
(5)		Opens the Layout dialog box

4.5.1 Layout Dialog Box

Fig. 4-14 shows the Layout dialog box, and Table 4-14 describes its functions.

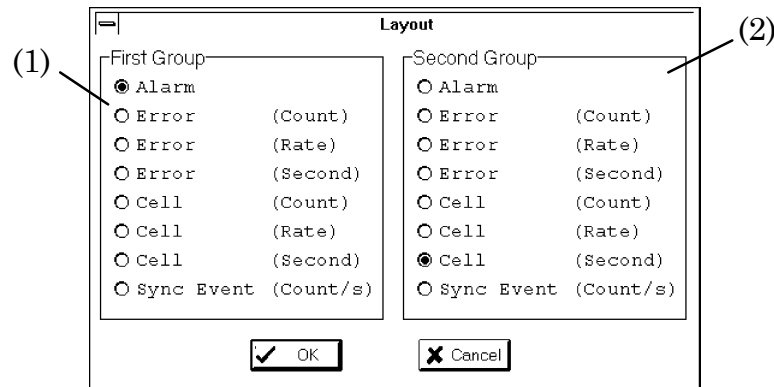

Fig. 4-14 Layout Dialog Box

Table 4-14 Description of Layout Dialog Box

Number	Item	Description
(1)	First Group	Selects a group box to be displayed in the Alarm/Error panel. Options are: Alarm, Error (Count, Rate, Second), Cell (Count, Rate, Second), and Sync Event(Count/s). If lengthwise-split or full screen is selected, the items selected here will appear on the left side of the display. If widthwise-split screen is selected, the items will appear on the upper side of the display.
(2)	Second Group	The same types of selections are made with First Group. If widthwise-split screen is selected, these items will appear on the bottom side of the screen.

4.6 Analyze Panel

Fig. 4-15 shows the Analyze panel, and Table 4-15 describes its functions.

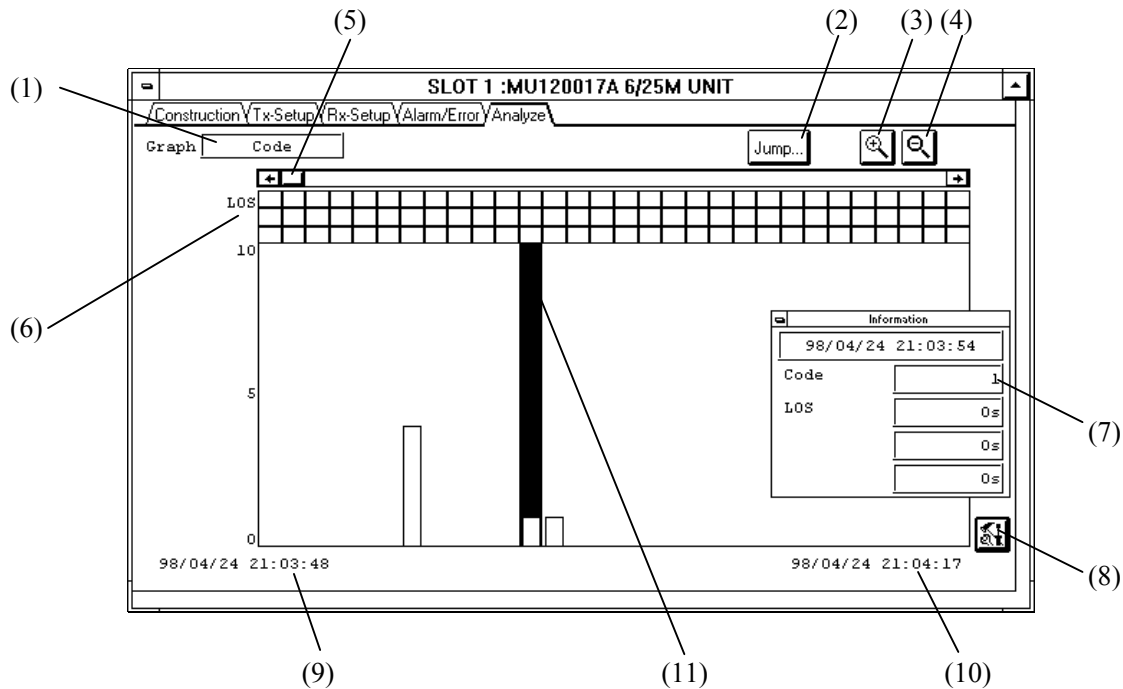





Fig. 4-15 Analyze Panel

Table 4-15 Description of Analyze Panel

Number	Item	Description
(1)	Graph	Displays the type of error shown in the graph. Settings can be modified in Analyze Setup dialog.
(2)	Jump..	Opens the Jump dialog box. It can not be selected when the Auto Scroll is performed.
(3)		Zooms out the graph in such a way that the marker always comes to the center of the screen.
(4)		Zooms in the graph in such a way that the marker always comes to the center for the screen.
(5)	[Scroll bar]	Scroll the screen horizontally.
(6)	[Alarm]	Shows the occurrence of alarms. Up to three alarm items can be displayed simultaneously.
(7)		Shows the time at the marker position, and detailed information of errors/alarms at that point.
(8)		Opens Analyze Setup dialog box.
(9)		Shows the time associated with the top of the graph currently displayed.
(10)		Shows the end time associated with the graph currently displayed.
(11)		The marker for specifying one bar in the bar graph. Specify it by clicking the bar or Jump dialog box.

4.6.1 Jump Dialog Box

Fig. 4-16 shows the Jump dialog box, and Table 4-16 describes its functions.

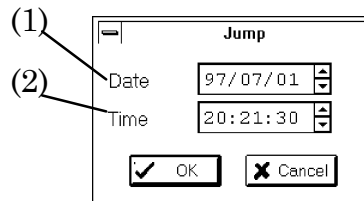

Fig. 4-16 Jump Dialog Box

Table 4-16 Description of Jump Dialog Box

Number	Item	Description
(1)	Date	Sets the date to the marker position to move to.
(2)	Time	Sets the time to the marker position to move to.

4.6.2 Analyze Setup Dialog Box

Fig. 4-17 shows the Analyze Setup dialog box, and Table 4-17 describes its functions.

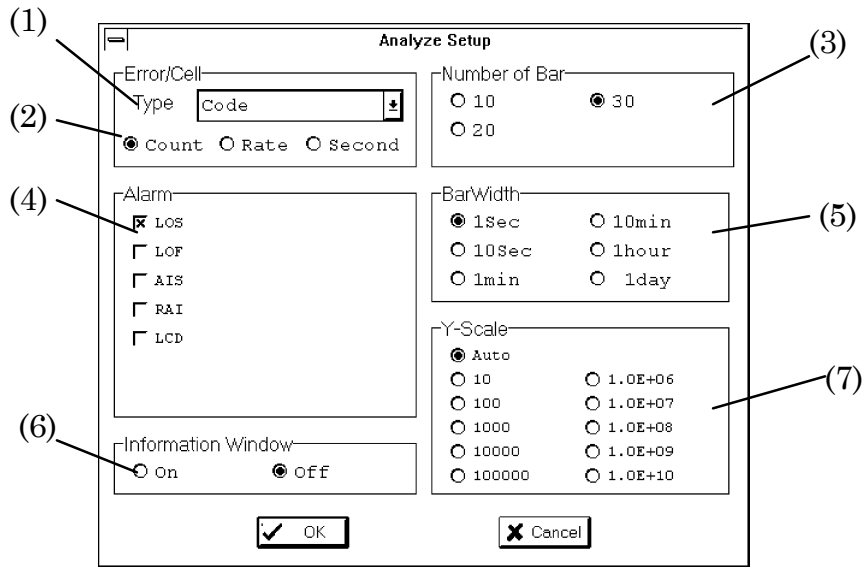

Fig. 4-17 Analyze Setup Dialog Box

Table 4-17 Description of Analyze Setup Dialog Box

Number	Item	Description
(1)	Type	Selects either an error or a cell to display in the graph. Only one item of error/cell is displayed at one time.
(2)		Selects the type of error to display. Count : Number of errors is displayed Rate : Error rate is displayed Second : Error seconds is displayed.
(3)	Number of Bar	Selects the number of bar graphs to be displayed on one screen.
(4)	Alarm	Selects alarm items to be displayed in the graph. Up to three alarm items can be shown at one time.
(5)	Bar Width	Selects the length of time indicated by one bar graph.
(6)	Information Window	Selects if 4.6 (8) is to be shown in Analyze sheet.
(7)	Y-Scale	Selects vertical axis for the bar graphs. Auto : Vertical axis is automatically scaled so that minimum vertical span that can contain the maximum graph value is automatically selected.

Section 5 Measurement

5.1 Performance Measurement

1. Connection

Connect the system as shown in Fig. 5-1, and turn the power on.

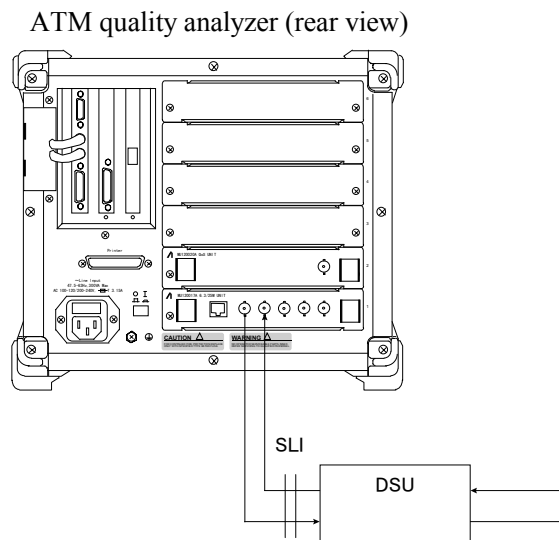



Fig. 5-1 Connection for Performance Measurement

2. Physical Interface Settings

Open the Physical Interface dialog box under Physical Interface group box in the Construction panel. Specify physical interface settings as follows:

Route	:	
Clock	:	Internal
Tx-Bitrate	:	6Mb/s
Rx-Bitrate	:	6Mb/s

3. Results of measurement

Open the Layout dialog box in the Alarm/Error panel. Select Error (Count), Error (Rate), or Error (Second) in either First Group or Second Group group boxes.

Push the start button (Go button) to start measurement, and the result will be displayed in the Alarm/Error panel. Either intermediate, or final results will be displayed by selecting Current or Last.

4. Analyze

If the use of the log file had been specified in the main frame, the user has an access, by opening an Analyze sheet, to the information concerning the time and frequency of error occurrence.

Section 5 Measurement

Section 6 Performance Test

6.1 About Performance Tests

This Section describe how to carry out performance tests to make certain that the unit is working properly. For detailed procedures to insert the unit to the main frame, to turn on power, and to open the MU120017A 6M/25M Unit windows, refer to the MP1220A ATM Quality Analyzer Operation Manual.

A performance test sheet is contained in Appendix A.

6.1.1 Alarm/Error Measurement Test

1. Connection

Connect the system as shown in Fig. 6-1, and turn on the power.

ATM quality analyzer (rear view)

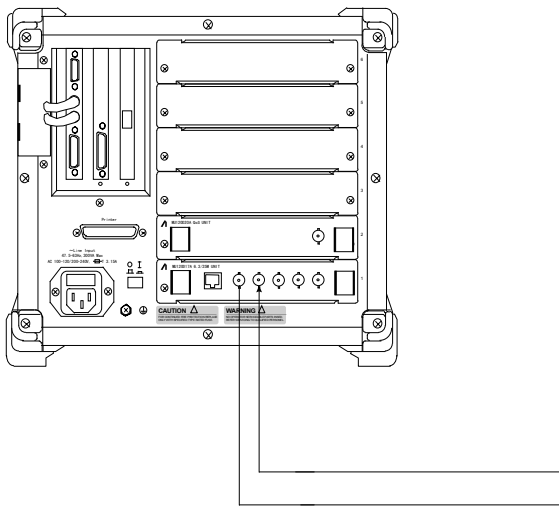



Fig. 6-1 Connection for Alarm/Error Measurements

2. Physical Interface Setup

Open the Physical Interface Setup dialog box under Physical Interface group box in the Construction panel. Specify physical interface settings as follows:

- Route : 
- Clock : Internal
- Tx-Bitrate : 6Mb/s
- Rx-Bitrate : 6Mb/s

3. Results of Measurements

Open the Layout dialog box in Alarm/Error panel. Select an item from the options: Alarm, Error(Count), Error(Rate), Error(Second), Cell(Count), Cell(Rate), and Cell(Second). Push the start button (Go button) to start measurements, and the results will be displayed in Alarm/Error panel. Either interim or final results will be displayed by selecting Current or Last.

Repeat steps 1 through 3 for each case in which Tx-Bitrate and Rx-Bitrate in physical interface are set to be 25Mb/s.

Section 7 Maintenance

7.1 Daily Maintenance

1. Wipe dirt off the instrument with a cloth and diluted synthetic detergent.
2. Suck dust with a vacuum cleaner.
3. If any part is found loose, use the dedicated tool to tighten it.

7.2 Notes on Storage

For a prolonged storage of the instrument, pay attention to the followings:

1. Remove dust and dirt from the instrument prior to storage.
2. Avoid storage in the place where temperature rises above 60°C, or falls below -20°C.
3. Avoid prolonged storage in a place where the sun directly hits the instrument, or dust may accumulate.
4. Avoid prolonged storage in a place exposed to direct sunlight or with much dust.
5. Avoid storage in a place where the instrument is exposed to oxidation or strong vibration.

7.3 Transportation

If the packing materials used for factory shipping have been preserved, do use them for the transportation of the instrument. Otherwise, follow the packaging procedures described below. Do not fail to wear a clean pair of gloves, and handle the instrument with care to avoid making scars or bruises on the surface.

1. Clean dirt and dust off the instrument's surface with a dry cloth.
2. Check if any part is missing or have become loose.
3. Protruding or damage-prone portion should be carefully protected. Wrap the instrument with sheets of polyethylene, and furthermore with sheets of moisture proof paper.
4. Place the wrapped instrument inside a cardboard box and seal the box with masking tapes. Transportation distance and method may necessitate the use of a cart box for protection.

7.4 Calibration

This instrument can only be calibrated by the manufacturer. Periodical calibration is recommended to maintain utmost performance.

Appendix

Appendix A Performance Test Sheet

Instrument : MU120017A 6.3/25M Unit	Report No. : _____
Serial No. : _____	Tested by : _____
Test Site : _____	Ambient Temperature : _____ °C
Date : ____ / ____ / ____ ()	Relative Humidity : _____ %
Notes : _____	_____
_____	_____
_____	_____

Alarm/Error Performance Test

Item	Criteria	Result	Pass/fail
Code	0[Count]		
CRC5	0[Count]		
LOS	0[s]		
LOF	0[s]		
AIS	0[s]		
RAI	0[s]		
LCD	0[s]		
Corrected	0[Count]		
Discarded	0[Count]		
Illegal	0[Count]		

Index

4

4B/5B 1-2, 1-5

A

AIS 1-3, 1-9

ATM-Forum 1-2, 1-5

B

B8ZS 1-2, 1-8

Bit 1-3, 1-9

BNC 1-2, 1-5, 1-8, 1-11, 1-12

C

Code 1-3, 1-6

Corrected Cell 1-3, 1-9

Coset 1-4, 1-6, 1-9

CRC5 1-3, 1-9

D

Discarded Cell 1-3

H

HEC 1-1, 1-4, 1-6, 1-9

Header error 1-1

I

Idle 4-9

Illegal Cell 1-3, 1-6

Index

L
LCD 1-3, 1-9
LOF 1-3, 1-9
LOS 1-3, 1-6, 1-9

M
Monitor point 4-4
MP1220A ATM Quality Analyzer v, 1-1
MU120015A ATM25M Unit ii, 1-1, 1-5, 1-11, 1-12
MU120016A 6.3M Unit ii, 1-1, 1-8, 1-11, 1-12
MU120017A 6.3/25M Unit 1-1, 1-2, 1-11
MU120020A QoS Unit 1-1
MU120021A Protocol Unit 1-1

N
NRZI 1-2, 1-5
NTT 1-2, 1-8

R
RAI 1-3, 1-9
Reception loopback 1-1, 4-5

S
Sync Event 1-3, 1-4, 1-6

T
Transmission loopback 1-1, 1-2

U
Unassigned 4-9
UTP 1-11, 1-12

V
Fill cell 1-4