

MF2400C Series

Microwave Frequency Counter



**MF2412/13/14C
Microwave Frequency Counter**

– Product Introduction –

**September 2007
Anritsu Corporation
Version 1.00**

MF2400C Microwave Frequency Counter

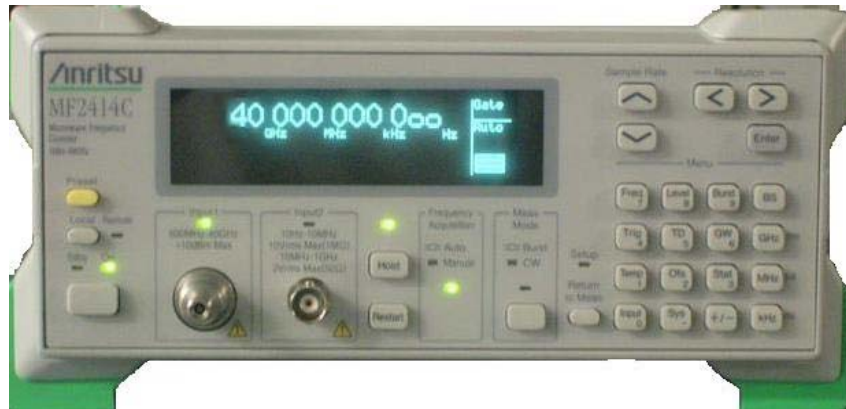

Wideband Measurement

20/27/40 GHz models

High-Accuracy Burst Measurement

Supports burst signal widths of 100 ns to 0.1 s

Analog Display Function

Displays easy-to-see changes in measured frequency

High-Speed Transient Measurement

Up to 10 μ s transient capture

Data memory for 2000 points max.

Graphical frequency display using host PC



MF2400C

Frequency Ranges to Match Application

The three models in the MF2400C Series have different upper frequencies to match the application and help cut capital investment.

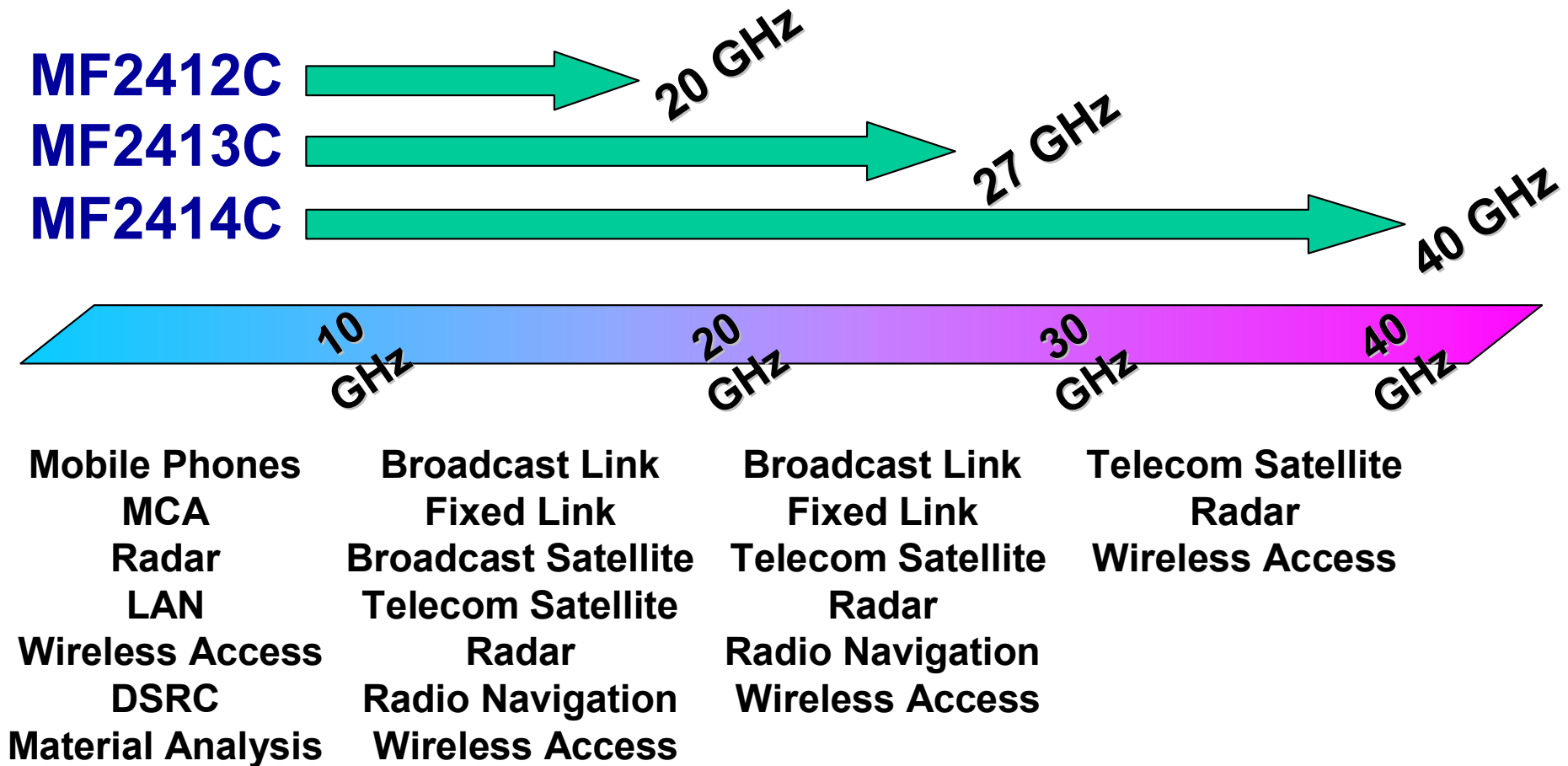

Full Range of Burst Signal Measurement Functions

The MF2400C Series has a full range of versatile burst measurement functions.

- Carrier Frequency
- Burst Reputation Frequency
- Burst ON Width

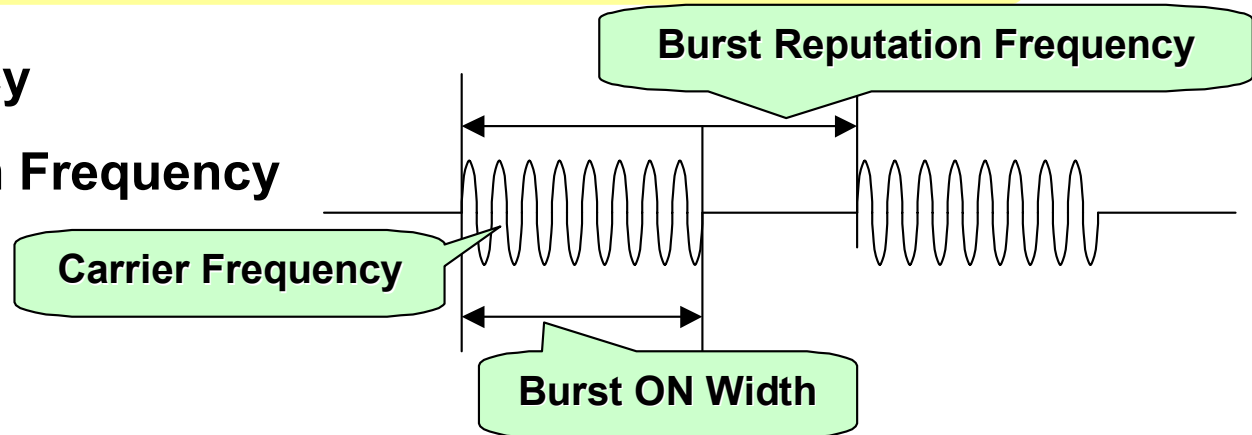

Any burst signal position and time interval can be specified for frequency measurement.

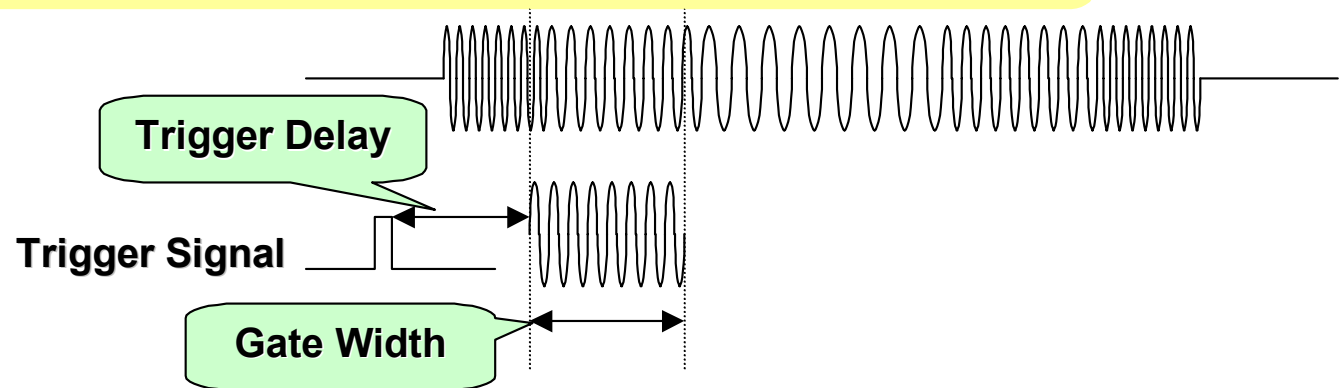

MF2400C

Analog Display Function

The MF2400C analog meters display markers at positions equivalent to the measured value...



... making it easy to see changes in measured frequency. Frequency can be fine-tuned and Go/No-Go evaluation performed simply and quickly.

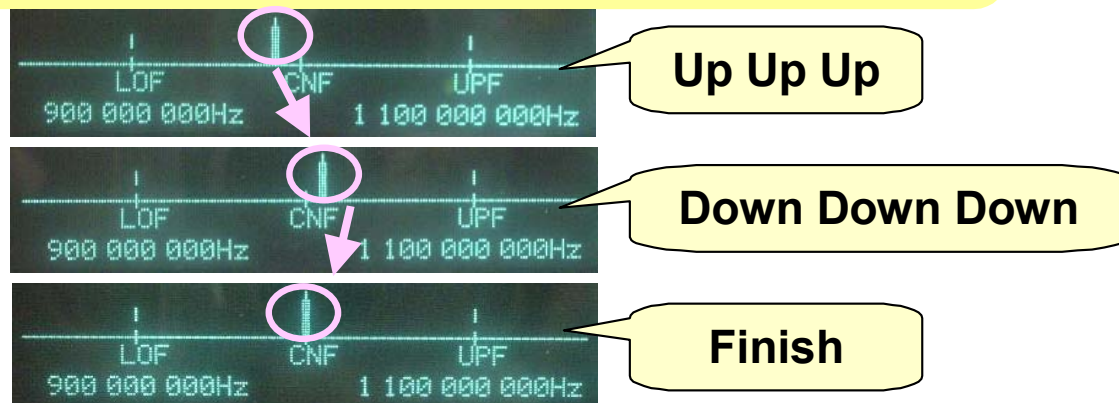

MF2400C Template Function

Go/No-Go is displayed at the preset limit.

When the upper and lower frequency limits are preset, Go is displayed when in the range, and No-Go is displayed when outside it.

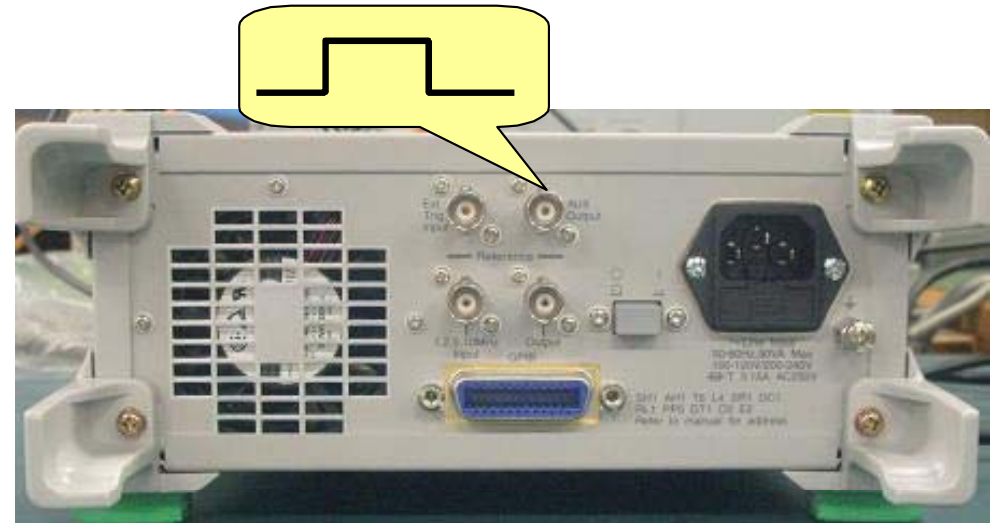
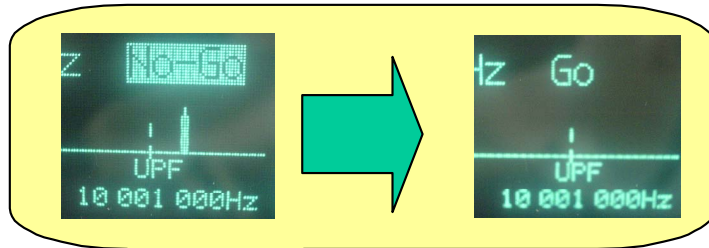

The Go/No-Go signal is output as a TTL signal from the back-panel AUX connector, which is useful for configuring automatic test systems.

MF2400C Option

High Stability Reference Crystal Oscillator

	Standard	Option-003
Frequency	10 MHz	10 MHz
Start Up Characteristics	$\pm 5 \times 10^{-8}/10$ minutes (After power-on, referenced to frequency after 1 h)	Unspecified
Aging Rate	$\pm 5 \times 10^{-9}/\text{day}$ (After power-on, referenced to frequency after 24 h)	$\pm 5 \times 10^{-10}/\text{day}$ $\pm 2 \times 10^{-8}/\text{year}$ (After power-on, referenced to frequency after 72 h)
Temperature Characteristics	$\pm 5 \times 10^{-8}$ ($25^\circ \pm 25^\circ\text{C}$)	$\pm 5 \times 10^{-9}$ (-10° to $+60^\circ\text{C}$, 25°C reference)

Appendix

Changes from MF2400 “B” to “C”



Changes from MF2400 “B” to “C”

Basic Specifications

Improved Display Visibility

The MF2400C Series uses a vacuum fluorescent display (VFD) offering good visibility in dark locations and wide viewing angle.

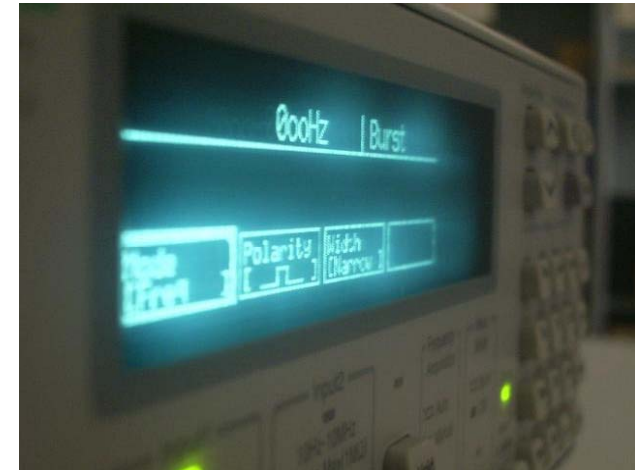

High-Stability Reference Crystal Oscillator

The MF2400C Series has a reference crystal oscillator with an order-of-magnitude better accuracy, eliminating the need to purchase an option and helping cut setup costs.

	“B” Series Standard Crystal Oscillator	“C” Series Standard Crystal Oscillator
Starting Characteristics	$\pm 5 \times 10^{-8}/10$ day (After 30-minute warm-up)	$\pm 5 \times 10^{-8}/10$ minutes (After power-on, referenced to frequency after 1 h)
Aging Rate	$\pm 2 \times 10^{-8}/\text{day}$ (After power-on, referenced to frequency after 24 h)	$\pm 5 \times 10^{-9}/\text{day}$ (After power-on, referenced to frequency after 24 h)
Temperature Characteristics	$\pm 5 \times 10^{-8}$ ($25^\circ \pm 25^\circ\text{C}$)	$\pm 5 \times 10^{-8}$ ($25^\circ \pm 25^\circ\text{C}$)

GPIB Function

The MF2400C Series does not support the GPIB talker function.

Changes from MF2400 “B” to “C” Options

The MF2400C Series has a reference crystal oscillator with an order-of-magnitude better accuracy, eliminating the need to purchase an option and helping cut setup costs.

“B” Series	Standard (10 MHz)	Opt-01 (10 MHz)	Opt-02 (10 MHz)	Opt-03 (10 MHz)
Starting Characteristics	$\pm 5 \times 10^{-8}/10$ day (After after 30-minutes warm-up)			
Aging Rate	$\pm 2 \times 10^{-8}/\text{day}$ (After power-on, referenced to frequency after 24 hours)	$\pm 5 \times 10^{-9}/\text{day}$ $\pm 5 \times 10^{-8}/\text{month}$ $\pm 7.5 \times 10^{-8}/\text{year}$ (After power-on, referenced to frequency after 24 h)	$\pm 2 \times 10^{-9}/\text{day}$ $\pm 3 \times 10^{-8}/\text{month}$ $\pm 4.5 \times 10^{-8}/\text{year}$ (After power-on, referenced to frequency after 24 h)	$\pm 5 \times 10^{-10}/\text{day}$ $\pm 1 \times 10^{-8}/\text{month}$ $\pm 1.5 \times 10^{-8}/\text{year}$ (After power-on, referenced to frequency after 24 h)
Temperature Characteristics	$\pm 5 \times 10^{-8}$ (0° to 50°C)	$\pm 5 \times 10^{-8}$ (-10° to 60°C, 25°C reference)	$\pm 1.5 \times 10^{-8}$ (-10° to 60°C, 25°C reference)	$\pm 5 \times 10^{-9}$ (-10° to 60°C, 25°C reference)

“C” Series		Standard (10 MHz)		Opt-003 (10 MHz)
Starting Characteristics		$\pm 5 \times 10^{-8}/10$ minute (After power-on, referenced to frequency after 1 h)		
Aging Rate		$\pm 5 \times 10^{-9}/\text{day}$ (After power-on, referenced to frequency after 24 h)		$\pm 5 \times 10^{-10}/\text{day}$ $\pm 2 \times 10^{-8}/\text{year}$ (After power-on, referenced to frequency after 72 h)
Temperature Characteristics		$\pm 5 \times 10^{-8}$ (25° ± 25°C)		$\pm 5 \times 10^{-9}$ (-10° to 60°C, 25°C reference)



Discover What's Possible™

MF2400C-E-L-1

Slide 11

Anritsu

Anritsu Corporation

5-1-1 Onna, Atsugi-shi, Kanagawa, 243-8555 Japan
Phone: +81-46-223-1111
Fax: +81-46-296-1264

● U.S.A.

Anritsu Company

1155 East Collins Blvd., Suite 100, Richardson,
TX 75081, U.S.A.
Toll Free: 1-800-267-4878
Phone: +1-972-644-1777
Fax: +1-972-671-1877

● Canada

Anritsu Electronics Ltd.

700 Silver Seven Road, Suite 120, Kanata,
Ontario K2V 1C3, Canada
Phone: +1-613-591-2003
Fax: +1-613-591-1006

● Brazil

Anritsu Eletrônica Ltda.

Praca Amadeu Amaral, 27 - 1 Andar
01327-010-Paraiso-São Paulo-Brazil
Phone: +55-11-3283-2511
Fax: +55-11-3288-6940

● U.K.

Anritsu EMEA Ltd.

200 Capability Green, Luton, Bedfordshire, LU1 3LU, U.K.
Phone: +44-1582-433200
Fax: +44-1582-731303

● France

Anritsu S.A.

16/18 avenue du Québec-SILIC 720
91961 COURTABOEUF CEDEX, France
Phone: +33-1-60-92-15-50
Fax: +33-1-64-46-10-65

● Germany

Anritsu GmbH

Nemetschek Haus, Konrad-Zuse-Platz 1
81829 München, Germany
Phone: +49-89-442308-0
Fax: +49-89-442308-55

● Italy

Anritsu S.p.A.

Via Elio Vittorini 129, 00144 Roma, Italy
Phone: +39-6-509-9711
Fax: +39-6-502-2425

● Sweden

Anritsu AB

Borgafjordsgatan 13, 164 40 KISTA, Sweden
Phone: +46-8-534-707-00
Fax: +46-8-534-707-30

● Finland

Anritsu AB

Teknobulevardi 3-5, FI-01530 VANTAA, Finland
Phone: +358-20-741-8100
Fax: +358-20-741-8111

● Denmark

Anritsu A/S

Kirkebjerg Allé 90, DK-2605 Brøndby, Denmark
Phone: +45-72112200
Fax: +45-72112210

● Spain

Anritsu EMEA Ltd.

Oficina de Representación en España

Edificio Veganova
Avda de la Vega, n° 1 (edf 8, pl 1, of 8)
28108 ALCOBENDAS - Madrid, Spain
Phone: +34-914905761
Fax: +34-914905762

● United Arab Emirates

Anritsu EMEA Ltd.

Dubai Liaison Office

P O Box 500413 - Dubai Internet City
Al Thuraya Building, Tower 1, Suit 701, 7th Floor
Dubai, United Arab Emirates
Phone: +971-4-3670352
Fax: +971-4-3688460

● Singapore

Anritsu Pte. Ltd.

60 Alexandra Terrace, #02-08, The Comtech (Lobby A)
Singapore 118502
Phone: +65-6282-2400
Fax: +65-6282-2533

● India

Anritsu Pte. Ltd.

India Branch Office

Unit No. S-3, Second Floor, Esteem Red Cross Bhavan,
No. 26, Race Course Road, Bangalore 560 001, India
Phone: +91-80-32944707
Fax: +91-80-22356648

● P.R. China (Hong Kong)

Anritsu Company Ltd.

Units 4 & 5, 28th Floor, Greenfield Tower, Concordia Plaza,
No. 1 Science Museum Road, Tsim Sha Tsui East,
Kowloon, Hong Kong
Phone: +852-2301-4980
Fax: +852-2301-3545

● P.R. China (Beijing)

Anritsu Company Ltd.

Beijing Representative Office

Room 1515, Beijing Fortune Building,
No. 5, Dong-San-Huan Bei Road,
Chao-Yang District, Beijing 10004, P.R. China
Phone: +86-10-6590-9230
Fax: +86-10-6590-9235

● Korea

Anritsu Corporation, Ltd.

8F Hyunjuk Building, 832-41, Yeoksam Dong,
Kangnam-ku, Seoul, 135-080, Korea
Phone: +82-2-553-6603
Fax: +82-2-553-6604

● Australia

Anritsu Pty. Ltd.

Unit 21/270 Ferntree Gully Road, Notting Hill,
Victoria 3168, Australia
Phone: +61-3-9558-8177
Fax: +61-3-9558-8255

● Taiwan

Anritsu Company Inc.

7F, No. 316, Sec. 1, Neihu Rd., Taipei 114, Taiwan
Phone: +886-2-8751-1816
Fax: +886-2-8751-1817

Please Contact: