

Anritsu - GRL

PCIe 3.0 BASE Rx Test Application

Release Note

Ninth Edition

This software is released for PCIe BASE Rx Test.

Table of Contents

Item	Contents
1. Released Software ...Page 2	Provides information for this release.
2. Peripheral Devices ...Page 2	Shows the list of devices that can be controlled by this software.
3. Added Functions ...Page 3	Describes added functions for this release.
4. Bug Fixes ...Page 3	Describes bug fixes in the released software version.
5. Remaining Known Bugs ...Page 3	Describes known software bugs in this version to be fixed in future releases.
6. Usage Notes ...Page 4	Describes precautions for using this software.
7. Troubleshooting ...Page 7	Describes troubleshooting procedures for using this software.
Appendix ...Page 9	Describes Quick Startup Guide.

1. Released Software

The certificate software versions for Keysight / Tektronix Scope are shown in the following table.

Edition	GRL BASE Rx Test Application	Anritsu MX190000A	Scope	
			Keysight	Tektronix
09	V1.0.84	V6.01.05	DSAZ634A V06.60.00403	DPO77002SX V10.11.0.30
08	V1.0.75	V5.01.00	DSAZ634A V06.60.00403	DPO77002SX V10.11.0.30
07	V1.0.68	V4.10.20	DSAZ634A V06.55.00702	DPO77002SX V10.1.0.34
06	V1.0.66	V4.09.50	DSAZ634A V06.55.00702	DPO77002SX V10.1.0.34
05	V1.0.65	V4.09.41	DSAZ634A V06.55.00702	DPO77002SX V10.1.0.34
04	V1.0.63	V4.03.12	DSAZ634A V06.40.00714	DPO75902SX V10.0.8.138
03	V1.0.54	V4.03.12	DSAZ634A	DPO73304DX 10.8.3 Build 3
		V4.02.10	V06.40.00714	
02	V1.0.54	V3.00.05	DSAZ634A V06.20.01101	DPO73304DX 10.8.3 Build 3
01	V1.0.54	V2.05.08	DSAZ634A V06.20.01101	DPO73304DX 10.8.3 Build 3

2. Peripheral Devices

The peripheral devices of the application are shown in the following table.

Model	Name
MP1900A	Signal Quality Analyzer-R
MU181000B	12.5GHz 4port Synthesizer (Option02 is required.)
MU181500B	Jitter Modulation Source
MU195020A or MU196020A	21G/32G bit/s SI PPG or PAM4 PPG
MU195040A	21G/32G bit/s SI ED
MU195050A	Noise Generator

For the installation position of the mainframe, refer to the Anritsu website (<https://www.anritsu.com>).

3. Added Functions

Version	Description
V1.0.84	Adds option to choose between PCIe Base Spec 3.0 or 4.0 calibration targets
V1.0.75	Supports insertion loss target in Gen4 spec Updates MOI
V1.0.66	Turns OFF PPG output after testing complete and when changing test setup
V1.0.65	Supports Keysight UXR scope
V1.0.63	Supports MU196020A PAM4 PPG

4. Bug Fixes

Version	Description
V1.0.84	Fixes DM calibration failure
V1.0.75	Fixes ACCM calibration target
V1.0.68	Fixes connectivity issue

5. Remaining Known Bugs

None

6. Usage Notes

The precautions for using each version are described below.

6.1 ISI Generator explanation

ISI Generator can be selected from the following two options:

- None
- Artek

This section explains these two options.

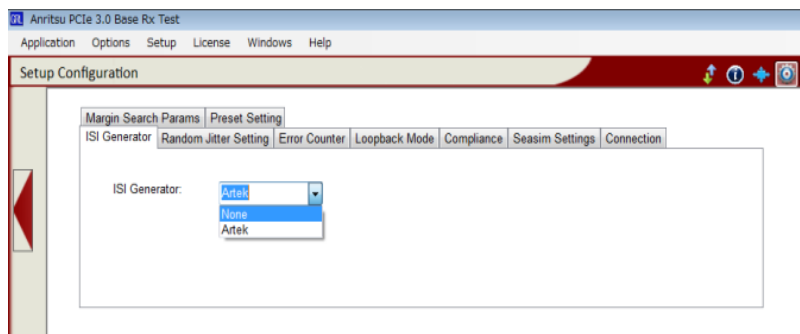

6.1.1 None (Recommended):

2.5 dB, 12 dB and 20 dB (@ 4GHz) Insertion Loss channels calibrated by VNA should be used for this setting. User fixtures would be acceptable if they meet the specifications below.

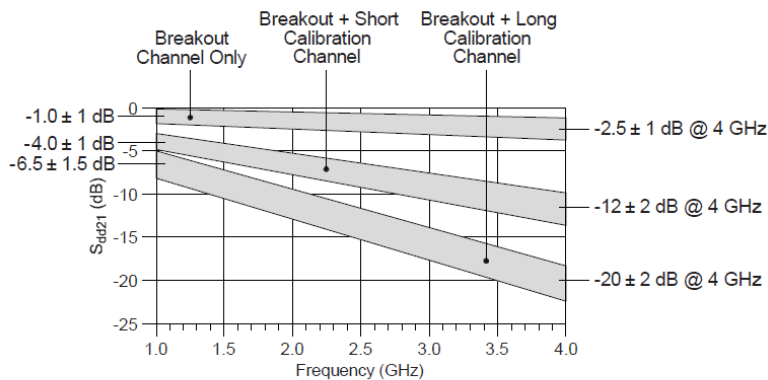

Figure 4-66: Insertion Loss Guidelines for Calibration/Breakout Channels

➤ Recommended configuration for Demonstration

Coaxial cables K-K(80 cm): 2 pairs

Adaptors SMA – SMP: 2 pairs

CBB3.0, Riser Board, CLB3.0, PCIe 4.0 Variable ISI: 1 for each

If the spec Insertion Loss (IL) values cannot be achieved, change the ISI pair number.

IL is smaller than expected.

Increase the pair number.

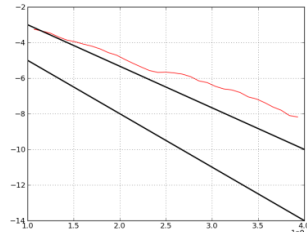

Proper IL

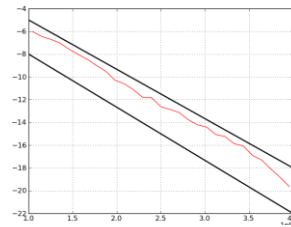

- Connection Diagram for Breakout Channel (GRL software: None)

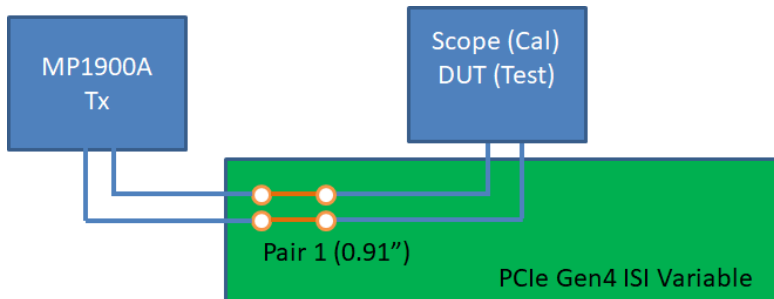

- Connection Diagram for Breakout + Short Calibration Channel (GRL software: Short)

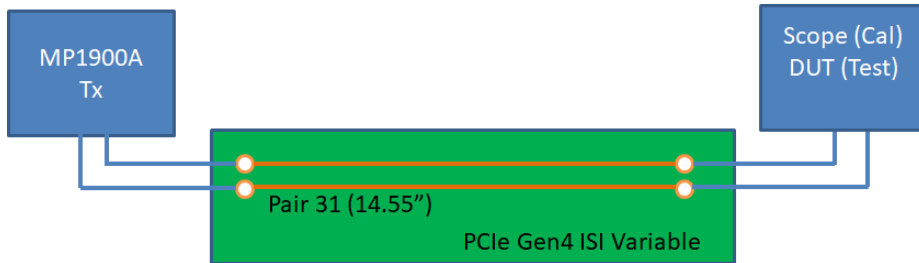

- Connection Diagram for Breakout + Long Calibration Channel (GRL software: Long)

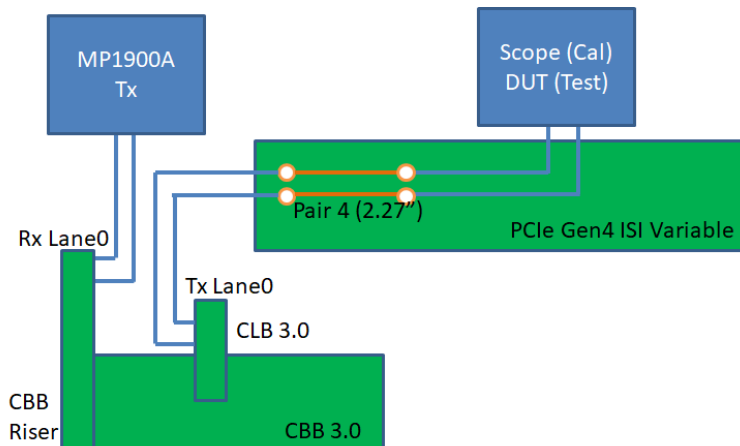

6.1.2 Artek (Optional):

This is an optional method to automate calibration sequence. This method also calibrates the Insertion Loss using Step Response of Seasim instead of VNA.

Artek CLE1000-S2 or A2 and PCIe 4.0 CEM ISI Variable / PCIe 4.0 Base Calibration Board are required for this setting. It is necessary to change connection by channel configuration.

Channel Configuration	Recommended Fixtures	
None (Breakout) (2.5 dB @4GHz)	CLE1000-S2	Fixed Board (PCIe 4.0 CEM ISI Variable pair 1)
Short (12 dB @4GHz)	CLE1000-S2	CLE1000-A2
Long (20 dB @4GHz)	CLE1000-S2 + Fixed Board (PCIe 4.0 CEM ISI Variable pair 26)	CLE1000-A2

7. Troubleshooting

If you encounter any errors during calibration or testing, check as follows.

7.1 Calibration

7.1.1 In case of an error when calibrating **Amplitude, Preset, SJ** and **RJ**

- Check the RF connections. Especially, the connection polarity (Pos/Neg) and the trigger connections (PPG Aux Out and Scope Aux In) are easy to mistake.
- Check the software version. A different version of software may cause an unexpected error.
- Check the SigTest version. SigTest version needs to be 3.2.0.3 for Gen3 or 4.0.52 for Gen4. Also, this should be installed to the directory C:\Program Files (x86). Do not change the installation directory from the default setting.

7.1.2 In case of a SigTest error when performing Long Channel Calibration

A SigTest error message is displayed and SigTest has stopped working when calibrating SJ, RJ and EH/EW. Since this message has no effect on calibration results, click **Close the program** to continue the calibration.

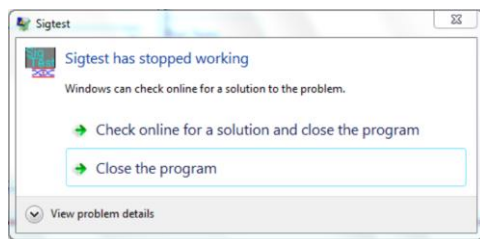

To avoid this message:

- Close all applications except the GRL software, MX190000A, MX183000A and scope applications. Especially when VNC is running, SigTest may not work properly.
- If you see this message frequently despite not running other applications on the PC, use another PC with the GRL software installed.

7.1.3 When Final Eye calibration cannot be succeeded

- Use the ISI Trace properly calibrated to 27 to 30 dB. It is recommended to use the calibration fixture distributed by the PCI-SIG.
- If any components (DC block, Power Divider, Attenuator and Adaptor) are attached to the Noise module output, remove them. These components may affect the waveform.

7.2 Others

7.2.1 When a session file cannot be loaded

- Close the folder where you installed the GRL software and saved PDF report file(s) because the loaded session file accesses and edits the folder.

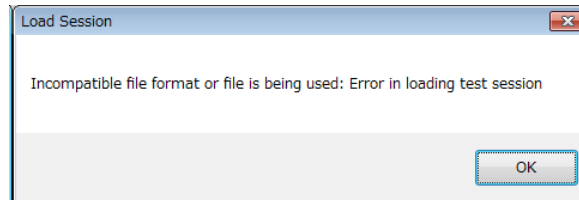

Appendix

A. Quick Startup Guide

1. Connect instruments with Ethernet cables as shown below.
2. Set the IP addresses as shown below. These can be set in the Network and Sharing Center (Windows OS feature).
3. Install all applications as shown below (Yellow letters).

- Recommended connection

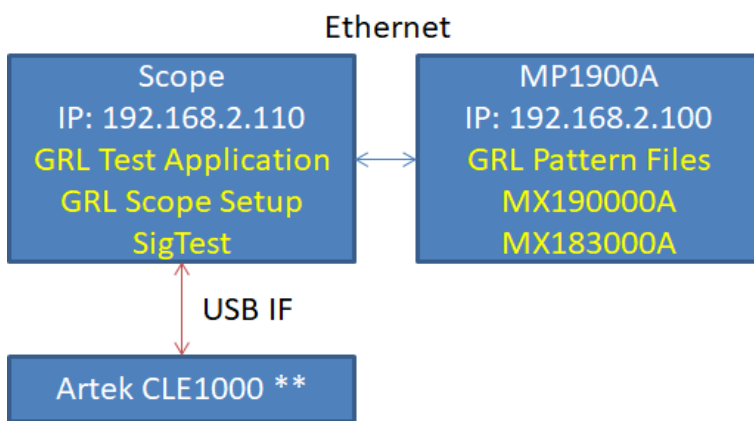

* Artek CLE1000 ISI Variable is not mandatory.

- Optional connection

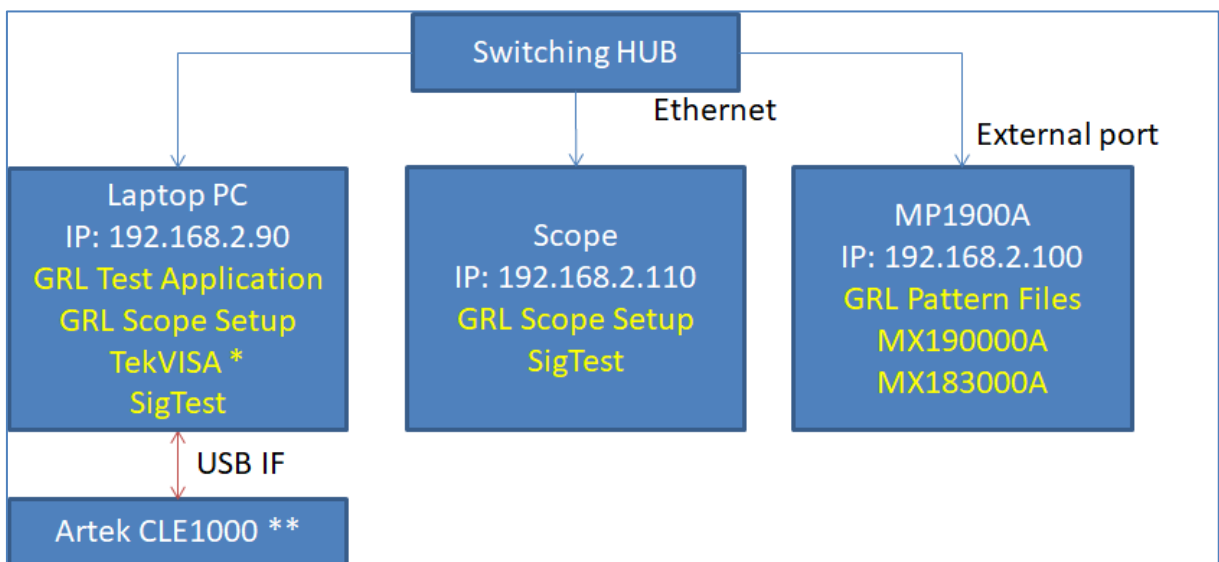

* TekVISA is needed to control Tektronix scopes. But, the PC on which TekVISA is installed cannot control Keysight scopes. Also, this configuration makes the remote-control speed slower than the recommended configuration.

* Artek CLE1000 ISI Variable is not mandatory.

- Launch application and configure equipment settings.
Enter the scope address as below and click . If the setting and connection are correct, the button will turn green.

Tektronix Scope

When the GRL software is installed on the laptop: TCPIP0::192.168.2.110::inst0::INSTR

When the GRL software is installed on the scope: GPIBX::1::INSTR*

- * Tektronix scope cannot use TCP/IP when the GRL software is installed on it. In this case, GPIB VISA should be set. The address can be checked using the VISA instruments Manager.

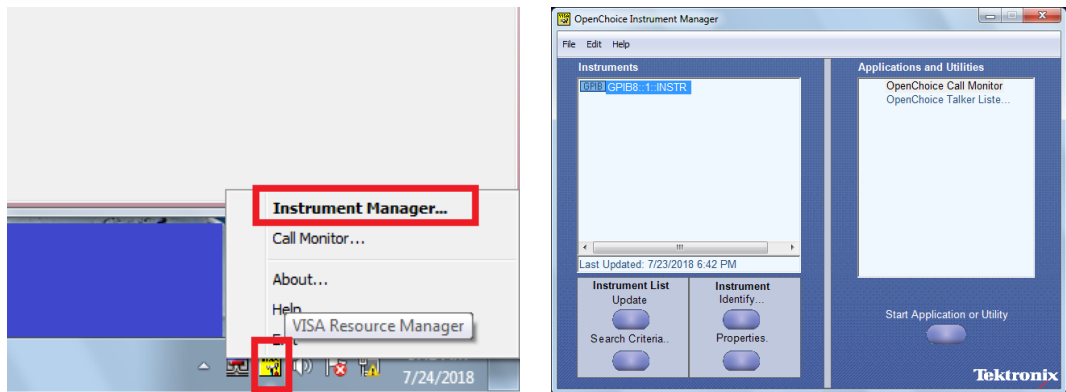

Keysight Scope

When the GRL software is installed on the laptop: TCPIP0::192.168.2.110::inst0::INSTR

When the GRL software is installed on the scope: TCPIP0::localhost::inst0::INSTR

MX190000A: TCPIP0::192.168.2.100::5001::SOCKET*

MX183000A: TCPIP0::192.168.2.100::5000::SOCKET*

- * Port numbers should be set for MX190000A and MX183000A.

ISI Generator: COM4*

- * Enter the COM number which can be checked by the CLE-1000 software.
- * The CLE1000 software must be closed when controlled by the GRL Software.

