

# Radio Communication Test Station

## MT8000A



# All-in-One 5G NR RF Measurements, Protocol Tests and Application Tests

**5G, Official Start**

Anritsu is releasing its new platform for developing 5G communications terminals, chipsets and devices.

With support for both RF measurements and protocol tests, this all-in-one platform can be configured easily for various tests, including RF measurements, protocol and application tests matching the module construction.

Anritsu — the leader in 4G testing — is also now taking the lead in 5G.



## Flexibility

### Measurement Module Configurations Matching Test Application

The all-in-one MT8000A supports RF measurements, protocol and application tests with a single unit while its flexible expandability not only meets future wider application needs but also helps cut-back new instrument investment and training costs for more efficient cost-performance.

## FR1 (to 7.125 GHz) — FR2

### Comprehensive Test Coverage from mmWave RF Measurements to Beamforming Tests

As well as supporting the FR1 (to 7.125 GHz) used by 5G, combining the MT8000A with OTA chambers also supports the FR2 (mmWave band) RF measurements and beamforming tests.

# MT8000A



## Software

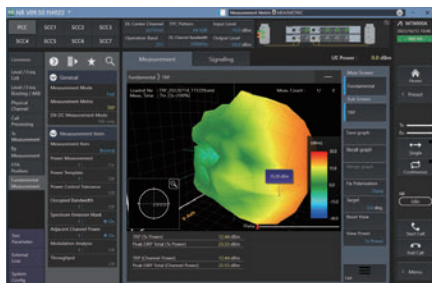

RF Measurement Software

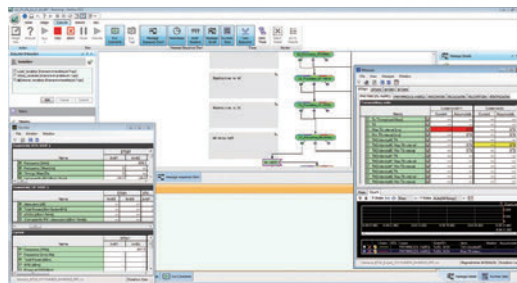

RTD for 5G NR

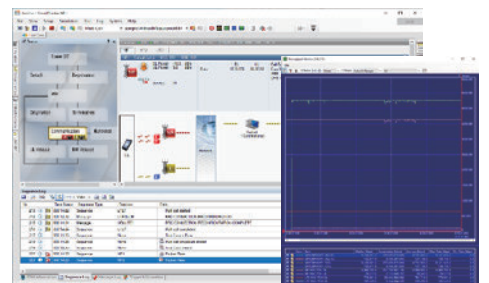

Function and Application Tests Software:  
SmartStudio NR  
SmartStudio NR IP Performance

\*: The design, explanation and appearance are subject to change without notice.

# The Wireless Communication Test Station for 5G Device Development

## Radio Communication Test Station MT8000A Features

### All-in-One Support for FR1 (to 7.125 GHz) and Millimeter Wave Bands

With a 5G base station emulation function, a single MT8000A test platform supports both the FR1 (to 7.125 GHz) and the FR2 (28 GHz/39 GHz/43.5 GHz) bands used by 5G. Combining it with the RF Chamber enables both millimeter wave band RF measurements and beamforming tests using call connections specified by 3GPP.

### Example of Supported Band

Band	n71 (600 MHz)	n41 (2.5 GHz)	n78-79 (3.5 G/4.5 GHz)	n257 (28 GHz)	n260 (39 GHz)	n259 (43.5 GHz)
	✓	✓	✓	✓	✓	✓

\*: Please enquire about other supported bands.

### Flexible Platform using Modular Architecture

Both Non-signalling and Signalling RF TRx measurements and protocol tests are supported by switching the test application at the common hardware platform.

In addition to supporting high-order MIMO (4x4 MIMO) and carrier aggregation (8CA) for implementing enhanced Mobile Broadband (eMBB), new 5G test needs, such as Ultra-Reliable and Low Latency Communications (URLLC) and massive Machine Type Communications (mMTC) are supported by the leading-edge design with flexibility and expandability based on the modular architecture.

A futureproof, flexible test environment is provided for a wide application range.

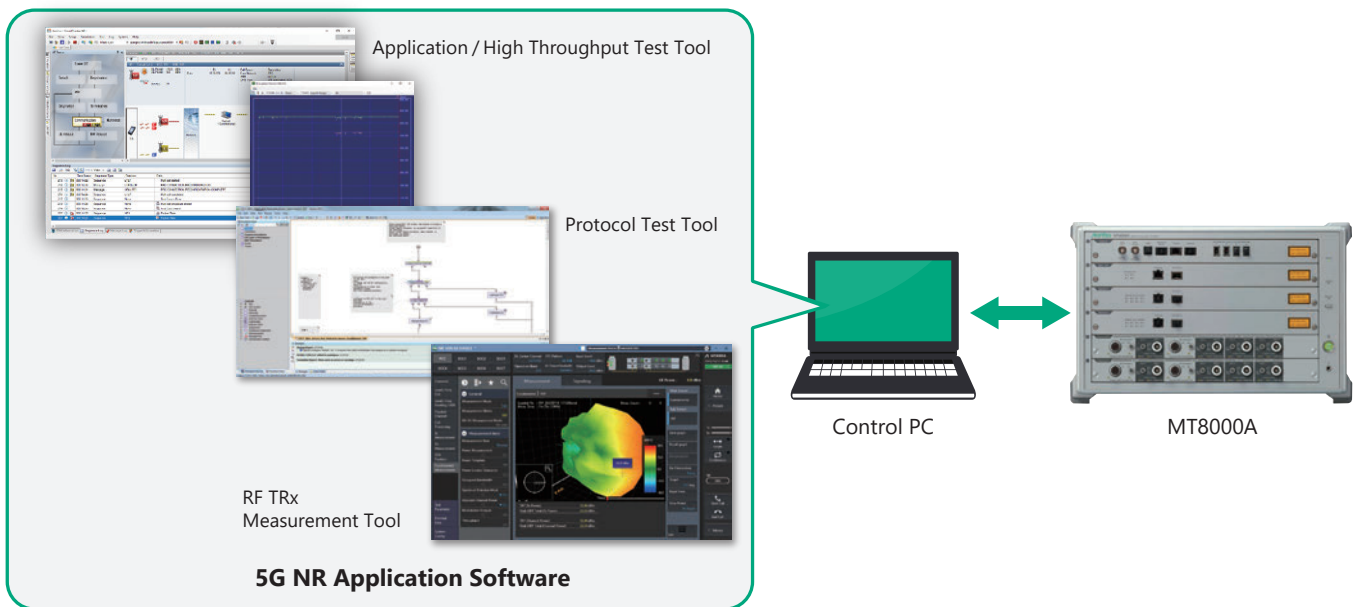

# The Wireless Communication Test Station for 5G Device Development

## Radio Communication Test Station MT8000A Features

### Supports Existing LTE Test Environment

A comprehensive test environment is provided by using Anritsu's LTE test platform offering leading-edge functions based on the company's long experience in this market. Easy configuration of a linked environment for simulating the 5G Non-Standalone (NSA) mode with LTE makes best use of measurement assets, such as the customer's test environment and test scenarios. (For RF, Protocol and Application tests, it is also possible to build an LTE test environment using the MT8000A.)

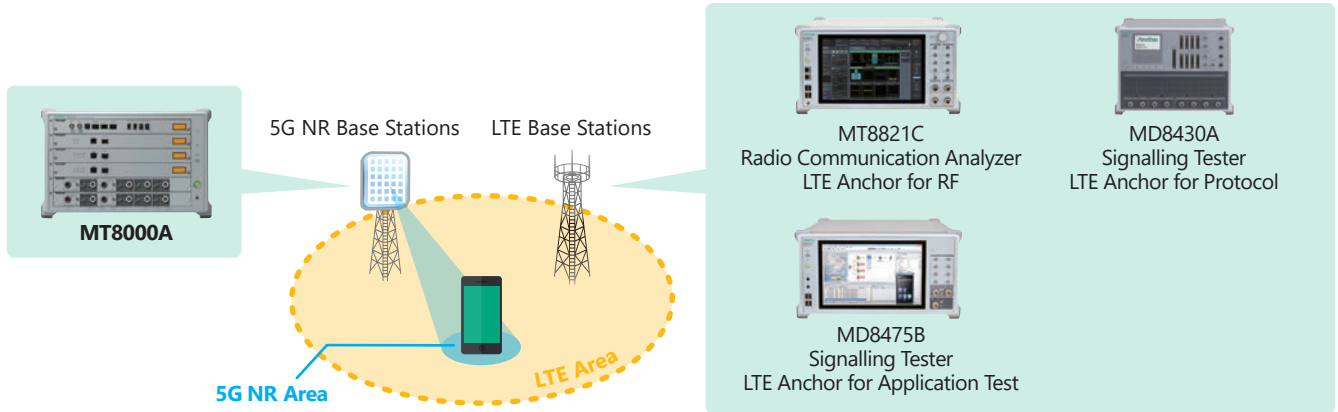

# Radio Communication Test Station MT8000A Features

## RF TRX Measurement GUI : MX800010A

### 3GPP RF Tests

Development and testing of mobile terminals and chipsets as well as network operator acceptance inspection tests, etc., are essential for evaluating compliance of the mobile terminal TRx performance with the 3GPP standards. With the increasing complexity of mobile terminal circuitry due to the use of more frequency bands, such as mmWave, the MX800010A software is an ideal solution for testing various aspects in support of 5G NR Mobile terminal RF TRx tests.

### Flexible Parameter Settings

The easy to change MX800010A parameter settings also support RF parametric tests and simplified protocol tests.

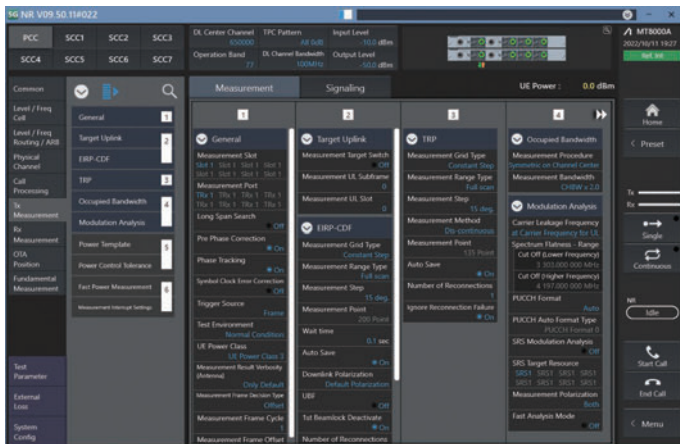

Typical Parameters (5G NR)

### Supports NSA Mode Tests

The 5G NR Non-Standalone (NSA) mode is supported. In the NSA mode, as well as using the Radio Communication Analyzer MT8821C as an LTE Anchor, the MT8000A with MX800010A-070 software option also supports NSA call connection and RF tests.

### Enhanced GUI for Efficient Operability

The MX800010A has the same easy to use and easy to understand GUI as the MT8821C. In addition to one-touch switching of listed and individual graph displays as well as summary and detailed displays of measurement results, the MX800010A supports convenient parameter setting functions such as, parameter searching and bookmarking for frequently used parameters.

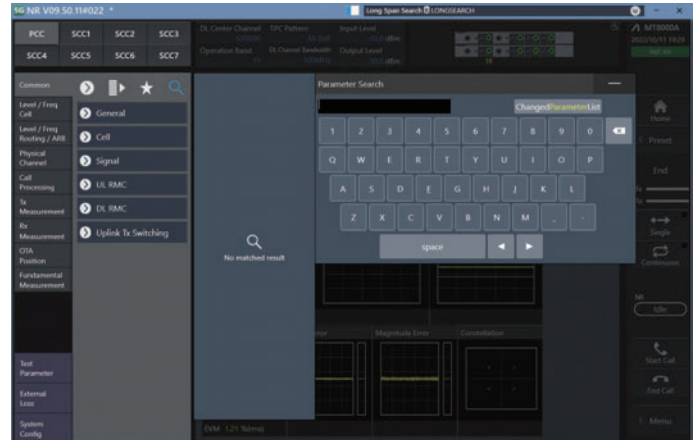

Parameter Search Function



Graph Display

# Radio Communication Test Station MT8000A Features

## RF TRX Measurement GUI : MX800010A

### OTA (Over The Air) Tests

OTA evaluation is required because the TRx performance of mobile terminals is influenced by factors such as the terminal form and antenna characteristics, etc.

There are two main types of 5G NR OTA test as follows:

- mmWave RF TRx Test
- Evaluating Mobile Terminal General TRx Performance Including Antenna

#### <mmWave RF TRx Test>

Since 5G NR uses an antenna array for sending and receiving signals in the mmWave band, evaluation of the RF TRx performance is performed using an OTA connection without an RF cable connection like that for LTE. Anritsu provides a turnkey mmWave RF TRx measurement solution including the RF chamber.

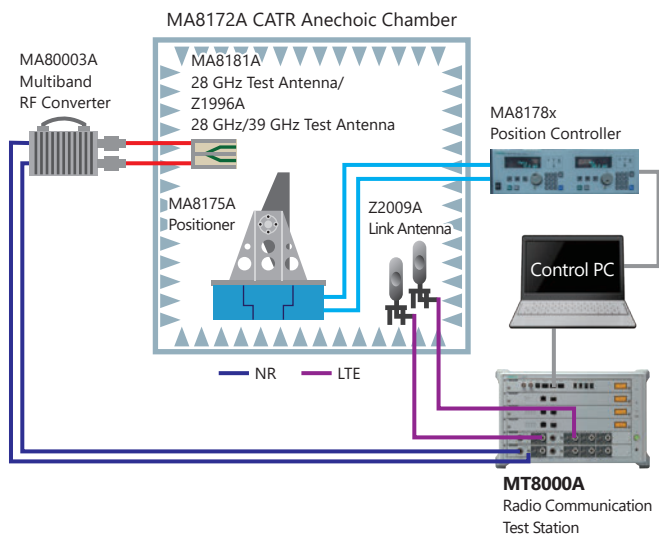

Can be constructed by combining MT8000A and MT8821C.

mmWave RF TRx Measurement Environment

#### <Evaluating Mobile Terminal General TRx Performance Including Antenna>

There are two antenna test methods: Total Radiated Power (TRP), and Total Radiated Sensitivity (TRS); various test systems using the MT8000A are available from OTA vendors.

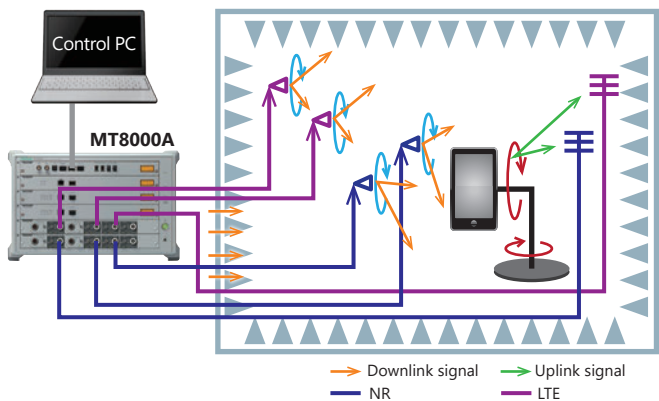

Can be constructed by combining MT8000A and MT8821C.

Radiowave Anechoic Chamber

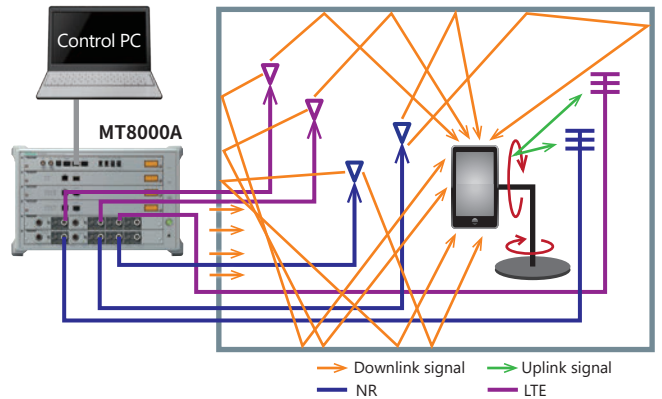

Can be constructed by combining MT8000A and MT8821C.

Reverberation Chamber

### SAR (Specific Absorption Rate) Test

The SAR test evaluates the amount of energy in the electromagnetic spectrum radiated from the mobile terminal absorbed by a jig known as a 'phantom', mimicking the human body. The purpose of this test is to help protect handheld users from adverse effects of electromagnetic waves on health. The specified amount of permissible absorbed energy is regulated by national and regional standards. The MT8000A fully supports 5G NR SAR tests.

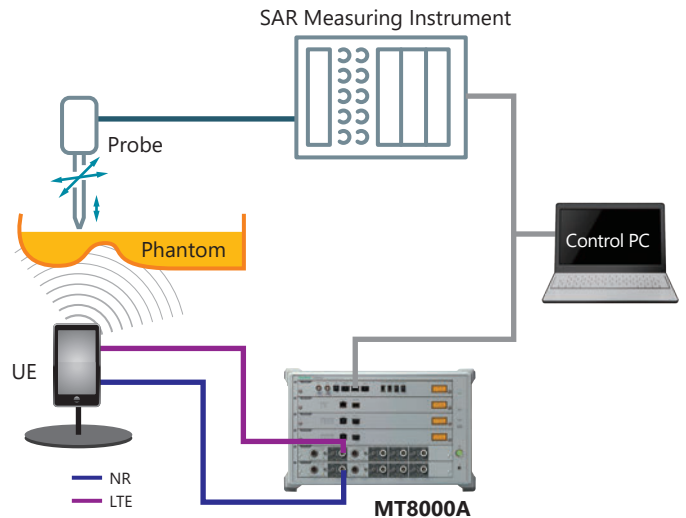

Can be constructed by combining MT8000A and MT8821C.

SAR Test Configuration

# Radio Communication Test Station MT8000A Features

## NR Protocol Test Solutions

### Encoding/Decoding Test

The 5G NR terminal encoding/decoding test is performed by connecting the equipment as follows using an RF cable.

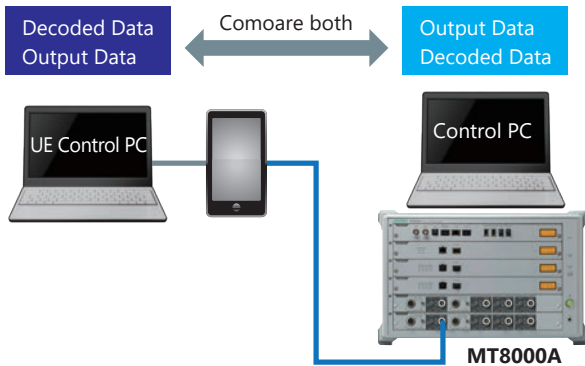

Encoding/Decoding Test Configuration (RF, Serial Control Test)

The Rapid Test Designer Platform (RTD) MX800050A and the NR Protocol Firmware MX800051A have built-in support for the digital baseband input/output function. Using the function supports high-reproducibility encoding/decoding tests without dependence on the performance of the RF section for stable baseband evaluation of 5G NR chipsets. In addition, 5G NR encoding/decoding tests are performed certainly because the baseband chip is evaluated at a slow clock below the clock frequency.

### Cuts Test Case Developer Training

With a full range of test procedures for Layer 1/2 and Layer 3 tests, the RTD software eliminates the need for specialist knowledge about TTCN code and unique simulator APIs, etc. Moreover, each procedure automatically sets the Layer 1/2 (L1/L2) connection conditions based on the complex 3GPP standards. Since the MD8430A can be controlled directly, 5G NR and LTE NSA test environments can be configured easily. Furthermore, the full range of available reference test samples with confirmed connections supports development of test cases using a library.

### Shortens Test Case Development Time

The RTD GUI makes it easy to create test cases using intuitive operations to connect procedures. Additionally, each procedure has a screen for setting various parameters, such as network conditions and message information, to increase test case variations using simple operation. Lastly, an analysis function checks for program mistakes prior to testing, and any code edits or changes are reflected immediately in the executed test.

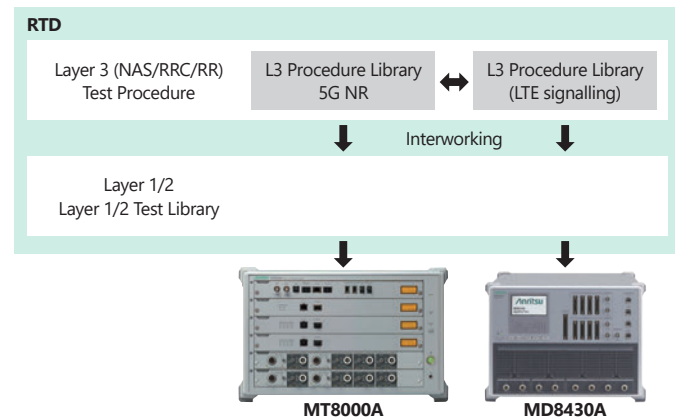

RTD Procedure Block

### Efficient Execution, Evaluation and Analysis

Test sequences can be confirmed in real-time during test execution and completed test results can be confirmed at a glance because Pass/Fail evaluations are defined within the test case. Moreover, detailed analysis is supported by integration of an HTML-based protocol analyzer with the RTD. Additionally, export of logs into HTML enables logs to be opened on any PC in the same manner as the protocol analyzer.

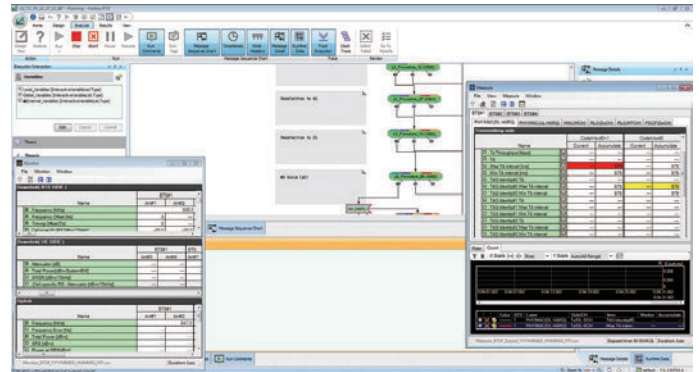

Test Execution Screen (RTD)

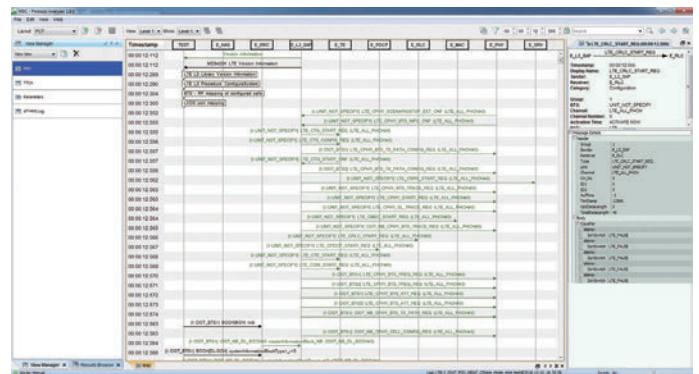

Log Analysis Screen (RTD)



# Radio Communication Test Station MT8000A Features

## NR Protocol Test Solutions

### Throughput Tests at Various Conditions

Combining the MX800030A with the Data Test Module MT8000A-012 supports IP throughput tests. Sample scenarios bundled with the software can be used to change parameters, such as bandwidth, scheduling, HARQ, etc., easily for running 5G NR IP throughput tests under various conditions.

### Handover Tests at Various Conditions

With support for up to 8 cells, handover tests between 5G NR 4CA cells are possible using only one MT8000A. Moreover, installing the Multi Box Data Connection MT8000A-009 option in the MT8000A enables up to 8CA 2x2 MIMO handover tests by connecting two MT8000A units. Lastly, combined use with the Signalling Tester MD8430A supports LTE interworking, helping maximize customers' investment in their existing hardware.

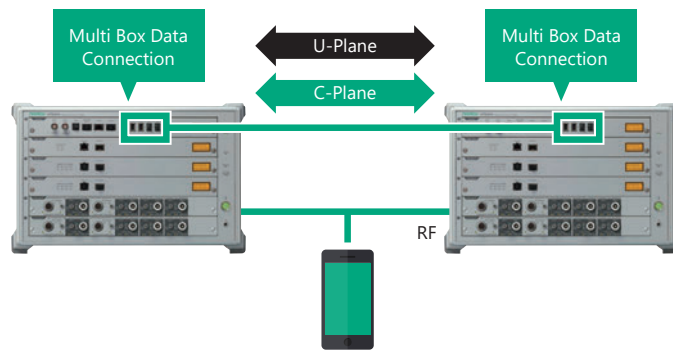

### Fully Versatile L1/L2 Monitoring Functions

To support the development of 5G terminals that process large volumes of low-layer data at very high speeds, the software enhances a full line of versatile power monitoring, throughput monitoring and log analysis functions. The Measure (Counter) functions can monitor Layer 1/2 (L1/L2) throughputs in real time by counting parameter values such as ACK/NACK/DTX/CQI.

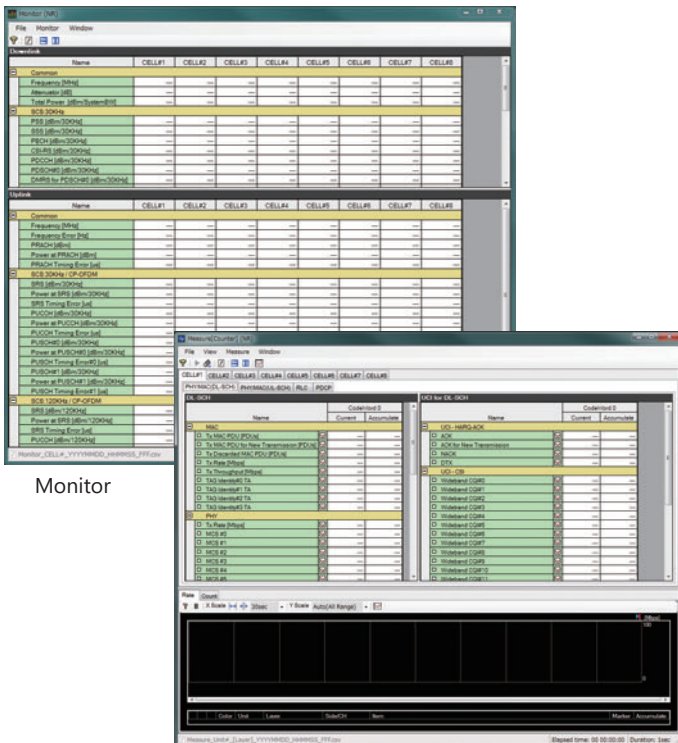

Monitor (Counter, Throughput Monitor)

### Powerful Test Automation

With support for mobile terminal control interfaces, the RTD software simplifies test automation. In addition, continuous multiple test case execution and automatic test report creation as well as various functions including repeat operation for a set number of times provide powerful support for automated testing.

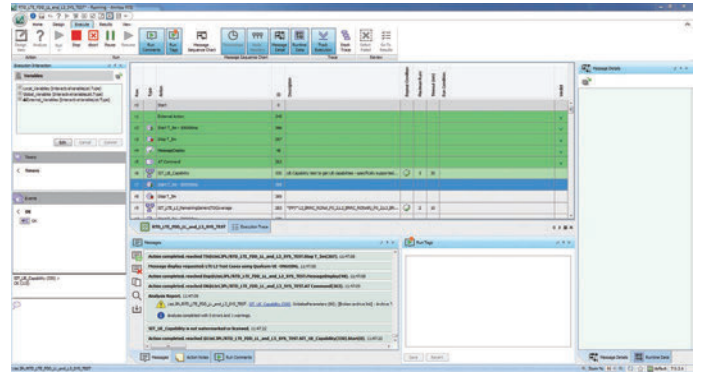

Example of Continuous Test Case Execution

### Easy Test Case Maintenance

Test cases created using the RTD software are easily updated for new 3GPP standard releases, helping cut test-case editing workloads. Moreover, recompiling is unnecessary because test cases maintain compatibility even after firmware updates. Consequently, test-case maintenance costs at commercial release of new mobile terminals are greatly reduced for pre-inspection regression tests and interoperability tests (IOT) with networking equipment.

### 5G NR/4G LTE Fading Tests

In cooperation with a fading PC, one MT8000A supports NR downlink fading tests up to 4CA 2x2 MIMO or 2CA 4x4 MIMO. Using two MT8000A units extends NR fading test support up to 8CA 2x2 MIMO or 4CA 4x4 MIMO. Furthermore, by adding one MT8000A for LTE BTS, it also supports the EN-DC fading test up to LTE 6CA 8x4 MIMO\*. The fading software includes 3GPP channel models which are compliant with TS38.521 for 5G NR (TDL), TS36.521 for 4G LTE. The channel models can be edited as necessary.

\*: Requires additional PC for LTE fading.

# Radio Communication Test Station MT8000A Features

## Application and Regression Tests for 5G devices: SmartStudio NR MX800070A

### 5G Device Application Tests

With an interactive GUI, SmartStudio NR MX800070A supports FR1/FR2 UE call connections, IP throughput tests, and IMS VoLTE testing, as well as Internet connections, live server application tests, and various mobility tests without requiring difficult scenario development. Moreover, user-generated test cases can be executed automatically using the SmartStudio Manager external control tool or an external control interface.

### Interactive GUI

The easy-to-use interactive GUI requires no knowledge of high-level protocols, and the current UE real-time status is displayed on the UE Status screen along with detailed protocol messages and sequences under the Log Display screen. Additionally, PDN settings, creation of test cases, etc., are supported.

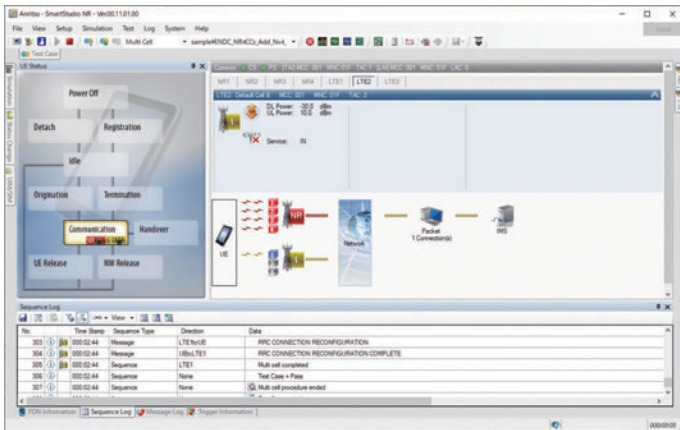

SmartStudio NR Main Screen

### Easy UE Capability Confirmation

UE Capability data are managed automatically and displayed at the UE Capability Information screen for easy confirmation during testing of UE-supported patterns, etc., of combinations of categories, bands, and CAs.

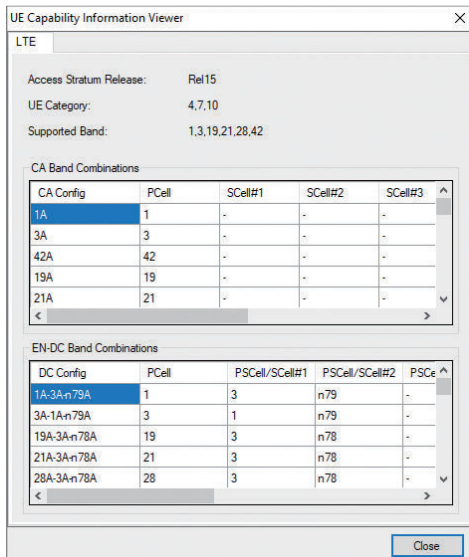

### Test Environment and Base Station Settings

The number of base stations in use, RAT, and antennas are set at the Simulation Parameter screen. In addition, an RF cable setup diagram based on set parameters is displayed, providing strong support for configuring the user's test environment. SIM and other user parameters are also set easily.

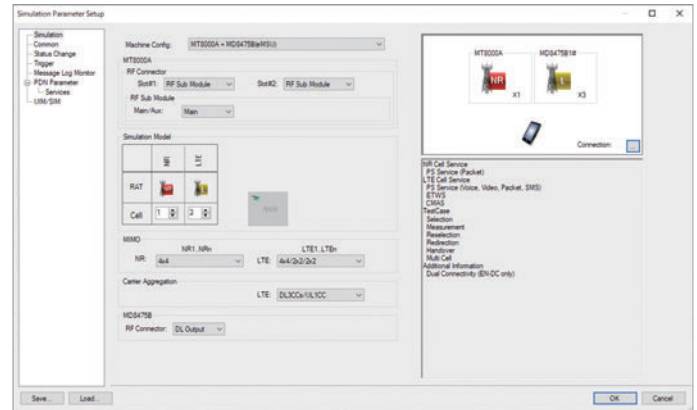

Simulation Parameter Settings Screen

Detailed parameters for each base station in use can be set at the Cell Parameter screen, where settings such as the band, frequency, bandwidth, UL/DL power, QAM, MCS, etc., can be set, saved, and loaded.

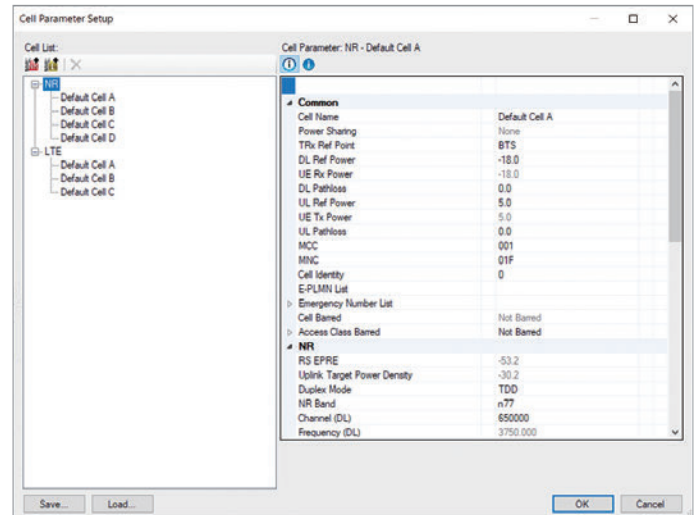

Cell Parameter Settings Screen

The base station TRx power can be changed during the simulation. In addition, base station transmissions can be stopped when executing the out of signal area test, and power can be controlled from the Test Case screen.

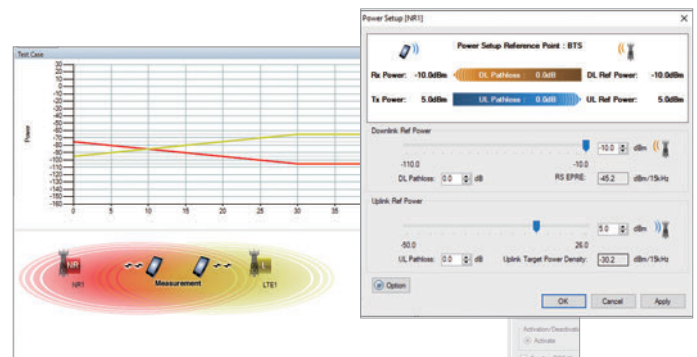

# Radio Communication Test Station MT8000A Features

## Application and Regression Tests for 5G devices: SmartStudio NR MX800070A

### Built-in IMS/PWS Service

With built-in IMS/PWS Service, the SmartStudio NR MX800070A supports VoLTE and SMS tests without requiring users to configure complex environments. Moreover, PWS Service tests, such as ETWS and CMAS, which are difficult to execute on a live network, are implemented easily, and message contents can also be edited.

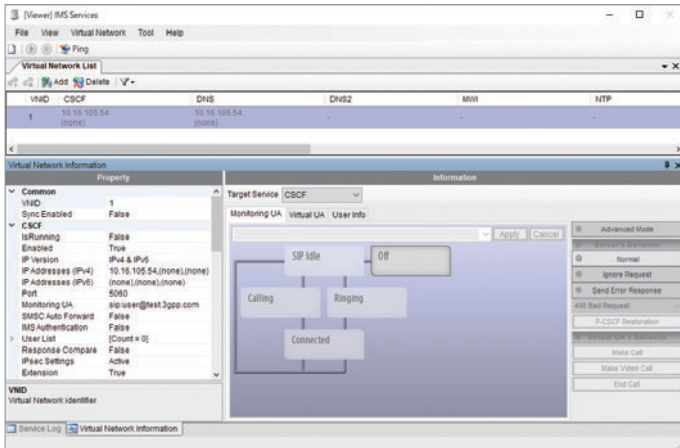

IMS Service Settings Screen

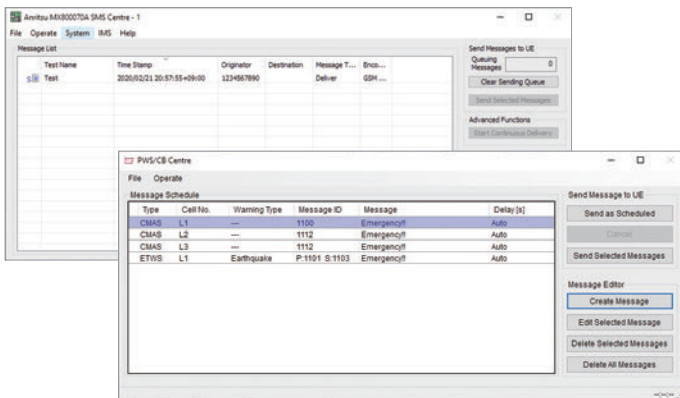

SMS/PWS Service Screen

### Test Automation

Studio NR and the UE can be controlled externally using SmartStudio Manager to configure an automated general test system. In addition to bundled test cases, users can create their own test cases with easy Pass/Fail confirmation after execution.

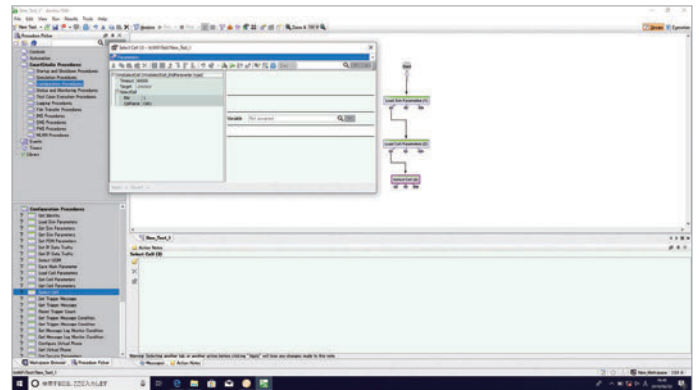

SmartStudio Manager Test Case Creation Screen

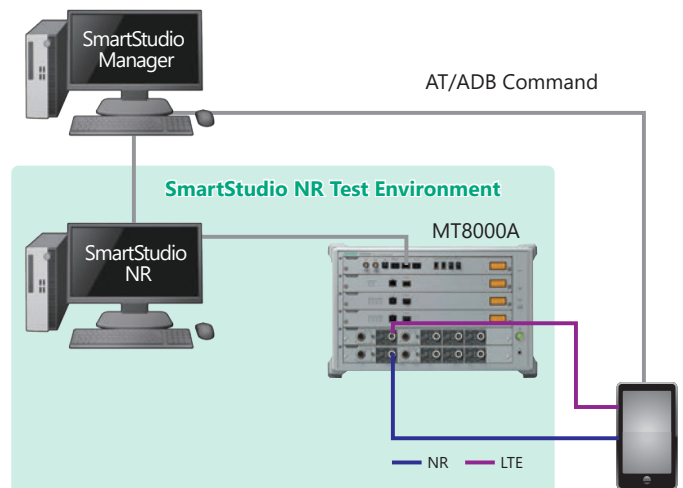

Can be constructed by combining MT8000A and MD8475B.

SmartStudio Manager Test Environment Example

# Radio Communication Test Station MT8000A Features

## Application and Regression Tests for 5G devices: SmartStudio NR MX800070A

### Evaluating Automobile Module Wireless Communications Ability:

**SSM Test PKG Telematics Connectivity MX847503A-TL660**

**SSM Test PKG Telematics Throughput MX847503A-TL661**

**SSM Test PKG Telematics Mobility Basic MX847503A-TL662**

The MX847503A-TL660/TL661/TL662 generates test patterns to analyze the wireless communications ability notified by the vehicle module and executes the test sequence.

The operation GUI displays the test sequence, sets the notification conditions, starts/stops the simulation, and automatically controls the test, including acquisition of measurement logs.

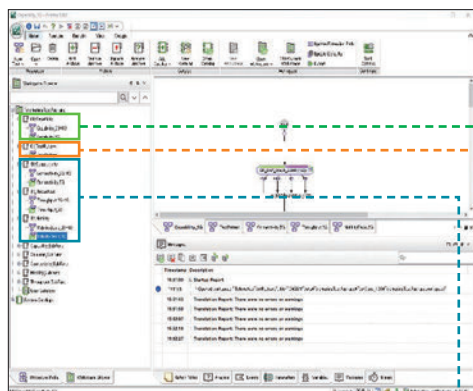

Provides evaluation procedure as test sequence

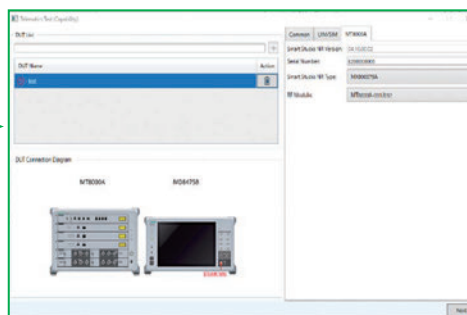

Step 1 Acquires vehicle module wireless communications ability

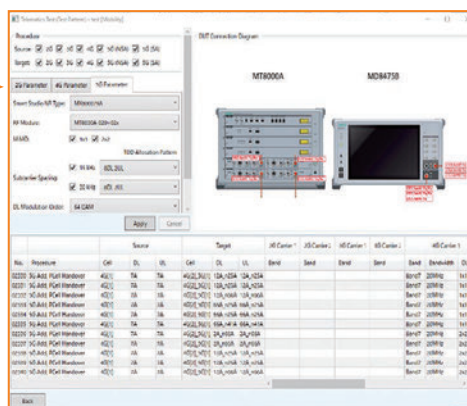

Step 2 Generates test pattern

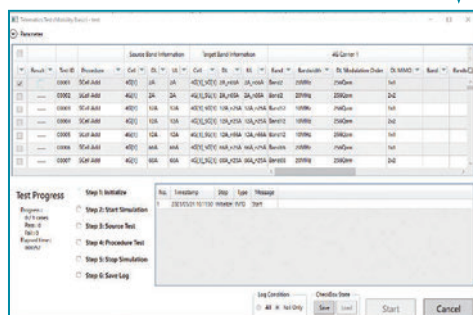

Step 3 Executes test (Connectivity/Throughput/Mobility)

# Radio Communication Test Station MT8000A Features

## Higher IP Data Throughput Test for 5G devices: SmartStudio NR IP Performance MX800071A

### More Efficient 5G Device IP Data Throughput Tests

The SmartStudio NR IP Performance MX800071A software solution supports easy and intuitive IP data throughput tests of 5G devices under a wide variety and increasing range of 5G band, CA, and MIMO combinations. Additionally, the MT8000A platform covering tests for each 4G/5G, NSA/SA wireless communication system simplifies conventional complex test environments using multiple platforms.

**Cell Parameter (CA, MIMO, TDD configuration, etc.)**

TDD Configuration Setup - Manual/Dedicated

DL/UL Periodicity	Pattern1	Pattern2
Slot	0 1 2 3 4 5 6 7 8 9 10 11 12 13 14 15 16 17 18 19 20	
DL/UL Allocation	0 0 0 0 0 0 0 0 0 0 0 0 0 0 0 0 0 0 0 0	
Number of DL Symbols	14 14 14 14 14 14 14 14 14 14 14 14 14 14 14 14 14 14 14 14	
Number of UL Symbols	0 0 0 0 0 0 0 0 0 0 0 0 0 0 0 0 0 0 0 0	
PUSCH		
K1	+5 -5 +4 -4 +3 -3 +2 -2 +1 -1 0 0 0 0 0 0 0 0 0 0	
Symbol	13 13 13 13 13 13 11 13 13 13 13 13 12 -13	
PUSCH #1		
Symbol		14
PUSCH #2		
Symbol		

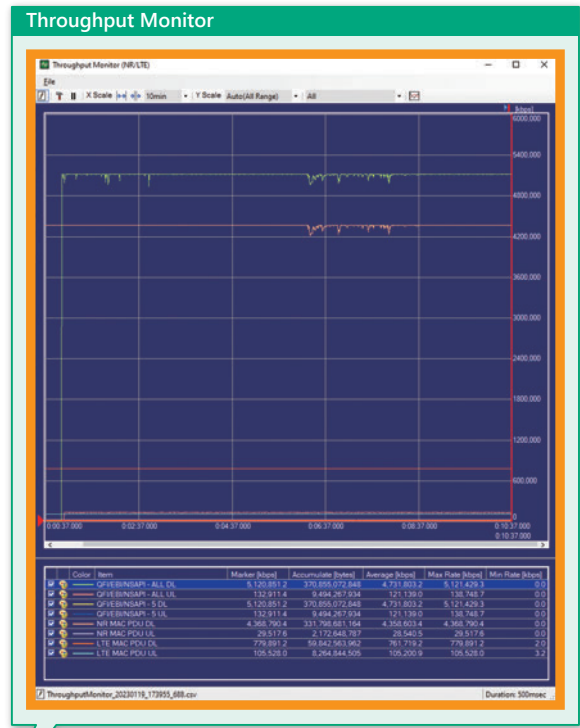

**Simulation Parameter (Frequency, Channel, BW, etc.)**

Simulation Parameter Setup

Machine Config: MT8000A v-LTE

RF Sub-Module: RF Sub-Module

Simulation Model: NR LTE

RF Sharing: LTE DL (L7E/L7E2) LTE UL (L7E/L7E4) IA (L7E/L7E2)

**UE Status**

UE Status

Message Log

No.	Progress TL	RTS	Direction	Message
28	00:00:18.026	881	→	EMM IDENTITY RESPONSE
29	00:00:18.196	881	←	UE CAPABILITY ENQUIRY
30	00:00:18.583	881	→	UE CAPABILITY INFORMATION
31	00:00:19.910	881	←	RRM CONNECTION RECONFIGURATION
32	00:00:19.945	881	→	RRM CONNECTION RECONFIGURATION COMPLETE
33	00:00:19.945	881	→	EMM ATTACH COMPLETE/EMM ACTIVATE DEFAULT EPS BEARER CONTEXT ACCEPT
34	00:00:19.901	881	←	EMM EMM INFORMATION
35	00:00:33.986	881	←	RRM CONNECTION RECONFIGURATION
36	00:00:34.016	881	→	RRM CONNECTION RECONFIGURATION COMPLETE
37	00:00:35.711	881	←	RRM CONNECTION RECONFIGURATION
38	00:00:35.752	881	→	RRM CONNECTION RECONFIGURATION COMPLETE

**Sequence Log between UE and MT8000A**

SmartStudio NR IP Performance Measurement Screen

# Radio Communication Test Station MT8000A Optional Accessories

## Butler Matrix 8x8: MA8118A

### Efficient IP/PHY Throughput Tests by Reducing RF Cable Changes During Testing

The 100+ 5G SA/NSA band combination patterns resulting from higher-order Carrier Aggregation and extended FR1 frequency range require an efficient test method.

The MA8118A supports MIMO tests that are not supported by RF combiner combinations.

Consequently, the MA8118A supports efficient IP/PHY throughput tests when evaluating 5G devices by minimizing RF cable changes during testing.

**Direct RF Cable Link:**

- Needs re-cabling many times to test all UE band combinations

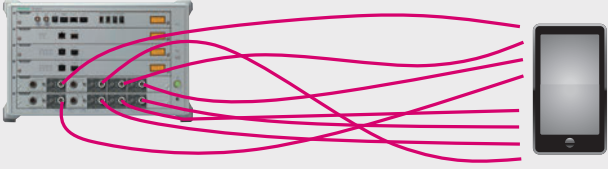

The diagram shows a test station on the left with multiple ports. Multiple red cables connect these ports to a smartphone on the right. A sad face icon is in the top right corner.

**RF Combiner Combinations:**

- No support for MIMO tests because RF combiners mix all signals

Cannot use RF Combiner Combinations

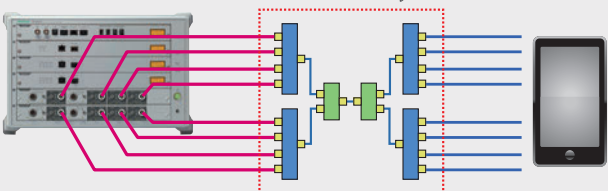

The diagram shows a test station on the left connected to a smartphone on the right through a series of RF combiners. A callout box with a sad face icon says "Cannot use RF Combiner Combinations".

**Butler Matrix (MA8118A):**

- Needs only minimum re-cabling to test all UE band combinations
- Supports MIMO testing because MA8118A divides all signals
- Supports Base Station/Wi-Fi AP MIMO tests

Easy MIMO Transmission Path Configuration

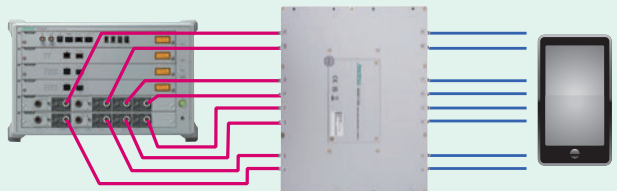

The diagram shows a test station on the left connected to a smartphone on the right via a Butler Matrix (MA8118A). A happy face icon is in the top right corner. A callout box says "Easy MIMO Transmission Path Configuration".



The diagram shows a base station and a Wi-Fi AP on the left connected to a Butler Matrix (MA8118A) in the middle, which is then connected to a smartphone on the right.

# Radio Communication Test Station MT8000A Layout

## MT8000A Front Panel



- 1 Ground Terminal**  
Functional ground terminal used as a measure against electrostatic discharge while using the MT8000A.
- 2 Power Switch**  
Switches power-on and standby. When the MT8000A is in the power on status, the LED lights up (green).
- 3 Standby LED**  
When the MT8000A is in the standby status of which the AC power is on, the LED lights (orange).
- 4 Recover LED/Recover Switch**  
Switch to recover MT8000A in case of emergency. Recovery LED lights up (orange) when the recovery function is enabled.
- 5 Caution LED**  
Lights up (orange) when MT8000A detects abnormality.
- 6 Ready LED**  
Lights up (green) when MT8000A startup is completed after power-on.
- 7 Control Module MT8000A-001 (with Multi-box Data Connection MT8000A-009)**  
Controls the entire MT8000A, processes upper layers, downloads firmware, and start MT8000A. Optical ports are used for connecting multiple MT8000As.
- 8 Data Test Module MT8000A-012**  
Performs data transfer for IP throughput test.
- 9 Baseband Module MT8000A-011**  
Performs baseband processing (L1/L2) in protocol test.
- 10 RF Base Module MT8000A-033**  
Converts digital signals into analog signals.  
Functions as RF interface for the external RF Converter or for RF signals in 2 GHz to 7.125 GHz.

# Radio Communication Test Station MT8000A Layout

## MT8000A Modules

### Control Module MT8000A-001

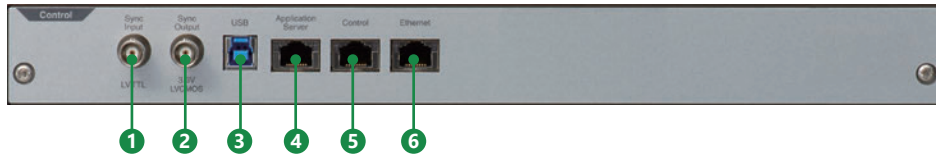

### Control Module MT8000A-001 + Multi-box Data Connection MT8000A-009

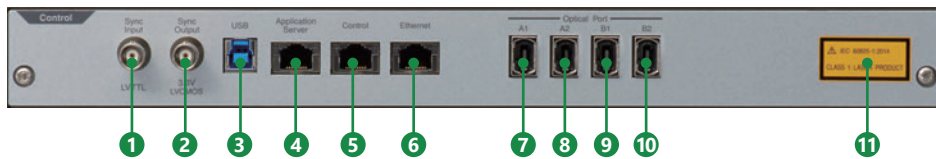

- 1 Sync Input Connector**  
BNC connector for inputting synchronizing signal.
- 2 Sync Output Connector**  
BNC connector for outputting synchronizing signal.
- 3 USB Connector**  
USB (Type B) connector to connect the external PC.
- 4 Application Server Connector**  
RJ-45 connector to connect the external PC for Application Server.
- 5 Control Connector**  
RJ-45 connector for connecting the MT8000A and Control PC.
- 6 Ethernet Connector**  
RJ-45 connector for connecting the external PC, etc.
- 7 Optical Port A1 Connector**  
MPO connector A1 for connecting multiple MT8000As when MT8000A-009 Multi-box Data Connection is installed.
- 8 Optical Port A2 Connector**  
MPO connector A2 for connecting multiple MT8000As when MT8000A-009 Multi-box Data Connection is installed.
- 9 Optical Port B1 Connector**  
MPO connector B1 for connecting multiple MT8000As when MT8000A-009 Multi-box Data Connection is installed.
- 10 Optical Port B2 Connector**  
MPO connector B2 for connecting multiple MT8000As when MT8000A-009 Multi-box Data Connection is installed.
- 11 Explanatory Label**  
Indicates that the Optical Port A1, A2, B1, and B2 are Class 1 laser products.



# Radio Communication Test Station MT8000A Layout

## MT8000A Modules

### Data Test Module MT8000A-012



- 1 Data Test Status LED**  
Indicates the Data Test status.
- 2 Ethernet Connector for Data Test**  
RJ-45 connector for Data Test.
- 3 SFP/SFP+ Connector**  
Connector to insert SFP or SFP+ (application parts) into.
- 4 Explanatory Label**  
Indicates that the device is a Class 1 laser product when SFP or SFP+ are installed.

### Baseband Module MT8000A-011



- 1 Baseband Status LED**  
Indicates the Baseband status.
- 2 Ethernet Connector for Baseband**  
RJ-45 connector for Baseband.
- 3 SFP/SFP+ Connector**  
Connector to insert SFP or SFP+ (application parts) into.
- 4 Explanatory Label**  
Indicates that the device is a Class 1 laser product when SFP or SFP+ are installed.

# Radio Communication Test Station MT8000A Layout

## MT8000A Modules

### RF Base MT8000A-020

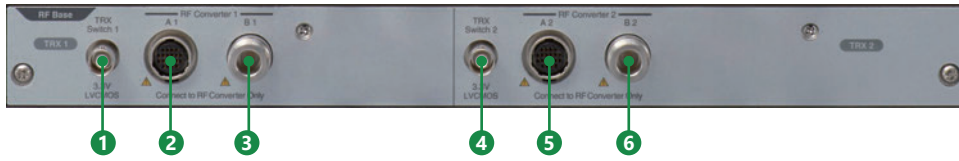

### MT8000A-020 + 3 GHz-12 GHz RF Sub Module MT8000A-022

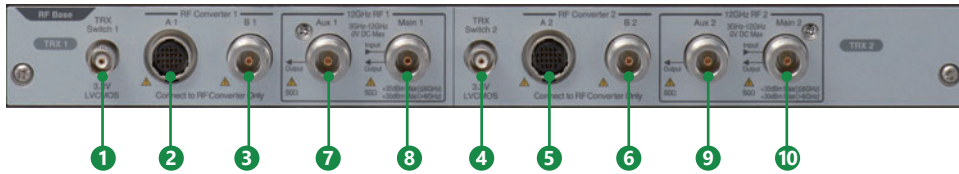

### MT8000A-020 + MT8000A-022 + Extend RF 2.4 GHz-3 GHz MT8000A-023

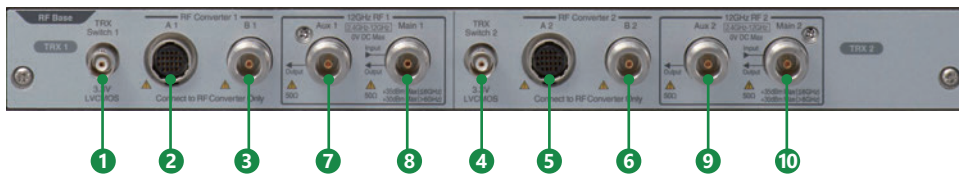

- 1 TRX Switch 1 Connector**  
BNC connector that outputs signals to control the external amplifier, etc.
- 2 RF Converter 1 A1 Connector**  
Multi-contact connector that controls the external RF Converter.
- 3 RF Converter 1 B1 Connector**  
N connector that input/output the external RF Converter and RF signals.
- 4 TRX Switch 2 Connector**  
BNC connector that outputs signals to control the external amplifier, etc.
- 5 RF Converter 2 A2 Connector**  
Multi-contact connector that controls the external RF Converter.
- 6 RF Converter 2 B2 Connector**  
N connector that inputs/outputs the RF signals between the external RF Converter and MT8000A.
- 7 12 GHz RF1 Aux 1 Connector**  
RF auxiliary connector (output) when 3 GHz-12 GHz RF Sub Module option is installed.
- 8 12 GHz RF1 Main 1 Connector**  
RF main connector (input/output) when 3 GHz-12 GHz RF Sub Module option is installed.
- 9 12 GHz RF2 Aux 2 Connector**  
RF auxiliary connector (output) when 3 GHz-12 GHz RF Sub Module option is installed.
- 10 12 GHz RF2 Main 2 Connector**  
RF main connector (input/output) when 3 GHz-12 GHz RF Sub Module option is installed.

Note: The frequency range indicated on the panel is "2.4 GHz-12 GHz" when MT8000A-023 Extend RF 2.4 GHz-3 GHz is installed. RF Converter 1 and RF Converter 2 cannot be used simultaneously with 12 GHz RF 1 and 12 GHz RF 2 respectively.

# Radio Communication Test Station MT8000A Layout

## MT8000A Modules

### RF Base Module MT8000A-020 + 0.4 GHz-6 GHz RF Sub Module MT8000A-021

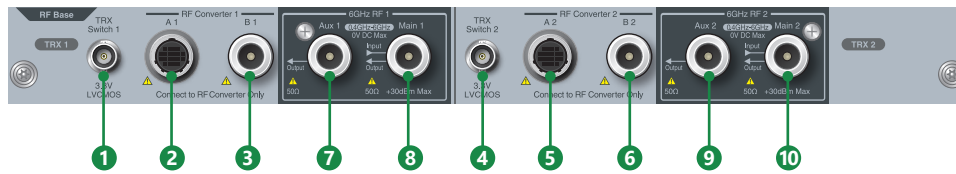

- 1 TRX Switch 1 connector**  
BNC connector that outputs signals to control the external amplifier, etc.
- 2 RF Converter 1 A1 connector**  
Multi-contact connector that controls the external RF Converter.
- 3 RF Converter 1 B1 connector**  
N connector that input/output the external RF Converter and RF signals.
- 4 TRX Switch 2 connector**  
BNC connector that outputs signals to control the external amplifier, etc.
- 5 RF Converter 2 A2 connector**  
Multi-contact connector that controls the external RF Converter.
- 6 RF Converter 2 B2 connector**  
N connector that inputs/outputs the RF signals between the external RF Converter and MT8000A.
- 7 6 GHz RF1 Aux 1 connector**  
RF auxiliary connector (output) when 0.4 GHz-6 GHz RF Sub Module option is installed.
- 8 6 GHz RF1 Main 1 connector**  
RF main connector (input/output) when 0.4 GHz-6 GHz RF Sub Module option is installed.
- 9 6 GHz RF2 Aux 2 connector**  
RF auxiliary connector (output) when 0.4 GHz-6 GHz RF Sub Module option is installed.
- 10 6 GHz RF2 Main 2 connector**  
RF main connector (input/output) when 0.4 GHz-6 GHz RF Sub Module option is installed.

Note: The frequency range indicated on the panel is "0.4 GHz-6 GHz" when 0.4 GHz-6 GHz RF Sub Module MT8000A-021 is installed.  
RF Converter 1 and RF Converter 2 cannot be used simultaneously with 6 GHz RF 1 and 6 GHz RF 2 respectively.

# Radio Communication Test Station MT8000A Layout

## MT8000A Modules

### Multi RF Module MT8000A-031/Multi RF Extension MT8000A-032

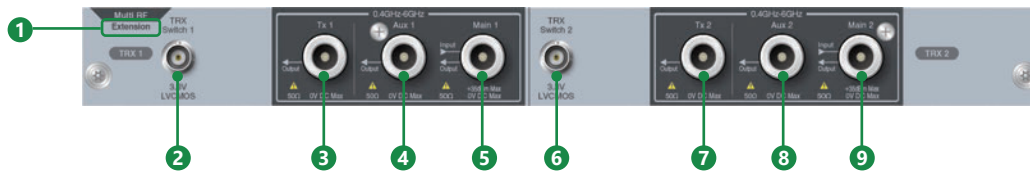

- 1 Extension marking**  
Mark for Multi RF Extension MT8000A-032. No mark for Multi RF Module MT8000A-031.
- 2 TRX Switch 1 connector**  
BNC connector that outputs signals to control the external amplifier, etc.
- 3 Tx 1 connector**  
RF transmission connector (output) for 0.4 GHz-6 GHz signal.
- 4 Aux 1 connector**  
RF auxiliary connector (output) for 0.4 GHz-6 GHz signal.
- 5 Main 1 connector**  
RF main connector (input/output) for 0.4 GHz-6 GHz signal.
- 6 TRX Switch 2 connector**  
BNC connector that outputs signals to control the external amplifier, etc.
- 7 Tx 2 connector**  
RF transmission connector (output) for 0.4 GHz-6 GHz signal.
- 8 Aux 2 connector**  
RF auxiliary connector (output) for 0.4 GHz-6 GHz signal.
- 9 Main 2 connector**  
RF main connector (input/output) for 0.4 GHz-6 GHz signal.

# Radio Communication Test Station MT8000A Layout

## MT8000A Modules

### 0.4 GHz-7.125 GHz Enhanced RF Module MT8000A-033

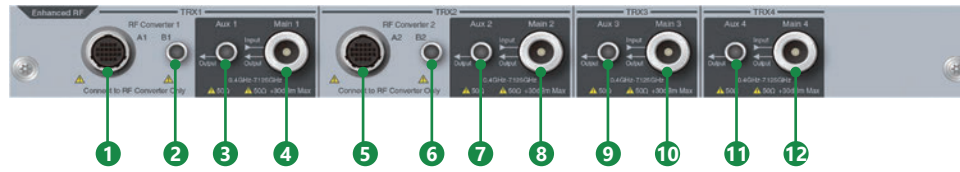

- 1 RF Converter 1 A1 connector**  
Multi-contact connector that controls the external RF Converter.
- 2 RF Converter 1 B1 connector**  
SMA connector that input/output the external RF Converter and RF signals.
- 3 Aux 1 connector**  
RF auxiliary connector (output) for 0.4 GHz-7.125 GHz signal.
- 4 Main 1 connector**  
RF main connector (input/output) for 0.4 GHz-7.125 GHz signal.
- 5 RF Converter 2 A2 connector**  
Multi-contact connector that controls the external RF Converter.
- 6 RF Converter 2 B2 connector**  
SMA connector that input/output the external RF Converter and RF signals.
- 7 Aux 2 connector**  
RF auxiliary connector (output) for 0.4 GHz-7.125 GHz signal.
- 8 Main 2 connector**  
RF main connector (input/output) for 0.4 GHz-7.125 GHz signal.
- 9 Aux 3 connector**  
RF auxiliary connector (output) for 0.4 GHz-7.125 GHz signal.
- 10 Main 3 connector**  
RF main connector (input/output) for 0.4 GHz-7.125 GHz signal.
- 11 Aux 4 connector**  
RF auxiliary connector (output) for 0.4 GHz-7.125 GHz signal.
- 12 Main 4 connector**  
RF main connector (input/output) for 0.4 GHz-7.125 GHz signal.

# Radio Communication Test Station MT8000A Layout

## MT8000A Rear Panel

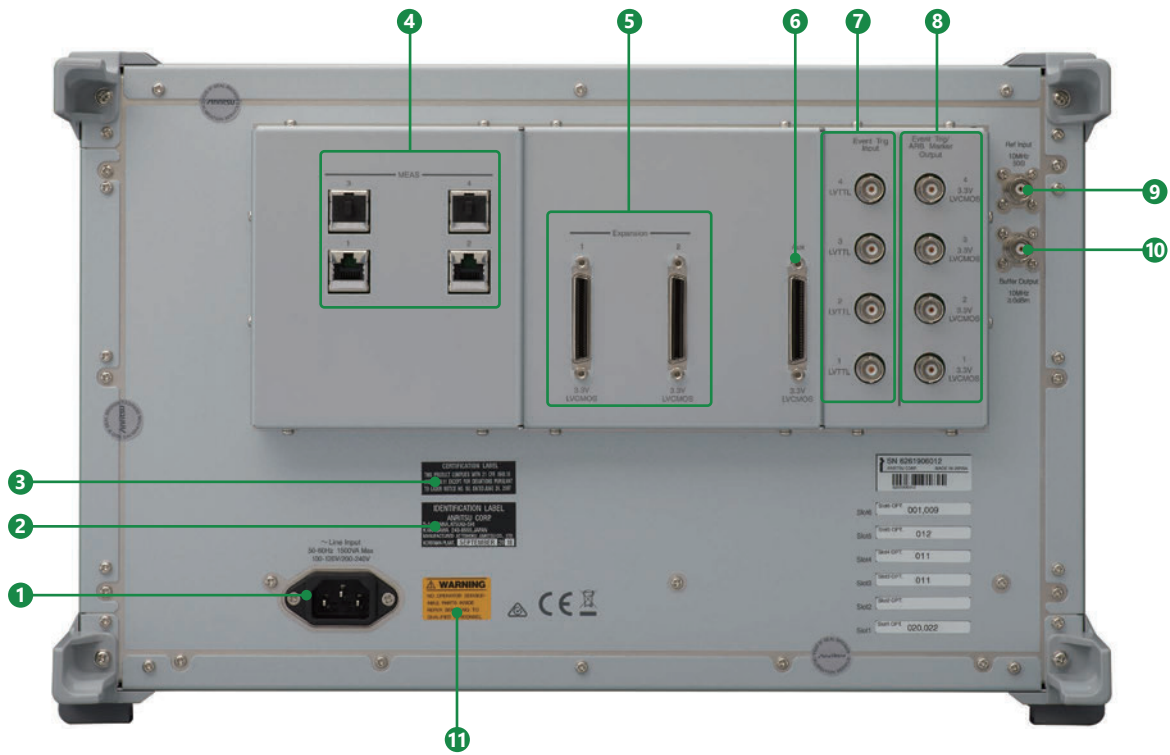

- 1 Power Inlet**  
Power cable connector for 100 VAC to 120 VAC or 200 VAC to 240 VAC (50 Hz/60 Hz) (auto-switching).  
Power consumption: 1500 VA or less.
- 2 Identification Label**  
Identifies the manufacturer of laser products.
- 3 Certification Label**  
Certifies that the MT8000A conforms to 21 CFR 1040.10 AND 1040.11 except Laser Notice No.50.
- 4 Ethernet Connector for Measure**  
RJ-45 connector for measurement.
- 5 Expansion Connector**  
Used for input/output of trigger signals.
- 6 Aux Connector**  
Auxiliary connector to output frame timing signals.
- 7 Event Trigger Input Connector**  
BNC connector to input event triggers from external devices. Can input event trigger signals of 4 systems.
- 8 Event Trigger Output Connector**  
BNC connector to output event triggers to external devices. Can output event trigger signals of 4 systems. Can be used also as output of ARB marker.
- 9 Reference signal input connector**  
BNC connector to input 10 MHz reference signal from external devices.
- 10 Reference Signal Output Connector**  
BNC connector to output 10 MHz reference signal built in the MT8000A.
- 11 Safety Label**  
WARNING label for safe operation of MT8000A. Observe the description on the label.

# Radio Communication Test Station MT8000A Layout

## System Configuration



- 1 Radio Communication Test Station MT8000A**  
All-in-one test platform supporting 5G RF measurements and protocol tests.
- 2 28 GHz RF Converter MA80001A/39 GHz RF Converter MA80002A/Multiband RF Converter MA80003A**  
Convert frequency of RF signal output from MT8000A to 28 GHz and 39 GHz band.
- 3 RF Chamber MA8171A**  
For 5G protocol tests in OTA environment.  
For 5G RF measurement, please use MA8172A (Refer to the OTA Product Catalog for details).
- 4 Position Controller MA8174A**  
Controls the Positioner MA8175A rotational angle inside the RF Chamber MA8171A.  
When using MA8172A, please use MA8178x. (Refer to the OTA Product Catalog for details).

# Radio Communication Test Station MT8000A Specifications

## Radio Communication Test Station MT8000A

Reference Oscillator	Reference frequency: 10 MHz Start-up characteristics: $\pm 5 \times 10^{-8}$ (3 min. after power-on. Referenced to frequency 1 hour after power-on) Aging rate: $\pm 1 \times 10^{-9}$ /day (referenced to frequency 48-hour after power-on) $\pm 1 \times 10^{-7}$ /year (referenced to frequency 10-day after power-on) Temperature characteristics: $\pm 2 \times 10^{-8}$ Frequency adjusted at shipment: $\pm 2.2 \times 10^{-8}$ (+18°C to +28°C, referenced to frequency 1 hour after power-on) 10 MHz Buffer Output Frequency: 10 MHz Connector: BNC (f) Impedance: 50Ω (nom.) Output Level: $\geq 0$ dBm (AC coupling) 10 MHz Ref Input Frequency: 10 MHz Operating range: $\pm 1$ ppm Connector: BNC (f) Impedance: 50Ω (nom.) Input level: $-15$ dBm $\leq$ level $\leq$ +20 dBm (AC coupling)	
External Interface	MEAS 1 to 4: RJ45, 1000Base-T, for slot 1 to 4 Event TRIG Input 1 to 4: BNC (f), LVTTTL Event TRIG/ARB Maker Output 1 to 4: BNC (f), 3.3 V LVCMOS Expansion 1, 2: DX20A (3.3 V LVCMOS) Aux: DX20A (3.3 V LVCMOS)	
Power Supply	Rated voltage: 100 VAC to 120 VAC/200 VAC to 240 VAC (Operating voltage is $-15\%/+10\%$ of rated voltage, however, lower limit is 90 V, upper limit is 250 V) Rated frequency: 50 Hz/60 Hz Power consumption: $\leq 1500$ VA (include all options and modules)	
Dimensions and Mass	Dimensions: 426 (W) $\times$ 265 (H) $\times$ 578 (D) mm (excluding projections) Mass: $\leq 50$ kg (including all options)	
Environmental Conditions	Operating temperature range: +5°C to +40°C (without condensation) Storage temperature: $-20^\circ\text{C}$ to +71°C (without condensation)	
CE	EMC	2014/30/EU, EN61326-1, EN61000-3-2
	LVD	2014/35/EU, EN61010-1
	RoHS	2011/65/EU, (EU) 2015/863, EN IEC 63000: 2018
UKCA	EMC	S.I. 2016 No.1091, EN 61326-1, EN61000-3-2
	LVD	S.I. 2016 No.1101, EN 61010-1
	RoHS	S.I. 2012 No.3032, EN IEC 63000:2018
Laser Safety*	IEC 60825-1 Class 1 FDA 21CFR1040.10 and 1040.11 Excludes deviations caused by conformance to LASER Notice No.50 dated June 24, 2007	

\*: Safety measures for laser products

This option complies with optical safety standards in IEC 60825-1, 21CFR1040.10 and 1040.11; the following descriptive labels are affixed to the product.

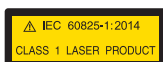

THIS PRODUCT COMPLIES WITH 21 CFR 1040.10 AND 1040.11 EXCEPT FOR DEVIATIONS PURSUANT TO LASER NOTICE NO. 50, DATED JUNE 24, 2007

## Control Module MT8000A-001

External Interface	USB: USB (Type-B) Application Server: RJ-45 (1000Base-T) Control: RJ-45 (1000Base-T) Ethernet: RJ-45 (1000Base-T) Sync Input: BNC (f) (LVTTTL) Sync Output: BNC (f) (3.3 V LVCMOS)
--------------------	---

## Multi-box Data Connection MT8000A-009

External Interface	Optical Port A1, A2, B1, B2: MPO optical adapter (m), 24 cores
--------------------	--

Typical (typ.): Performance not warranted.

Must products meet typical performance.

Nominal (nom.): Values not warranted.

Included to facilitate application of product.



# Radio Communication Test Station MT8000A Specifications

## Baseband Module MT8000A-011

External Interface	Ethernet: RJ-45 (1000Base-T) SFP/SFP+: SFF-8431, SFF-8472 compliant IEEE 802.3ae-2002, IEEE 802.3-2008 compliant
--------------------	--

## Data Test Module MT8000A-012

External Interface	Ethernet: RJ-45, 1000Base-T SFP/SFP+: SFF-8431, SFF-8472 compliant IEEE 802.3ae-2002, IEEE 802.3-2008 compliant
--------------------	---

## RF Base Module MT8000A-020

IF Input/Output Connector	RF Converter B1, B2 Connector: N (f) Impedance: 50Ω (nom.)
External Interface	RF Converter A1, A2: Round multiway type connector TRX Switch 1, 2: BNC (f) (3.3 V LVCMOS)

## 0.4 GHz-6 GHz RF Sub Module MT8000A-021

General	<p>RF input/output connector Main 1, Main 2 Connector: N (f) Impedance: 50Ω (nom.) VSWR At 0.4 GHz ≤ setting frequency &lt; 3 GHz ≤1.5 (0.4 GHz ≤ frequency &lt; 3.1 GHz) At 3 GHz ≤ setting frequency ≤ 6 GHz ≤1.5 (2.9 GHz ≤ frequency ≤ 6.1 GHz)</p> <p>RF output connector Aux 1, Aux 2 Connector: N (f) Impedance: 50Ω (nom.) VSWR At 0.4 GHz ≤ setting frequency &lt; 3 GHz ≤1.6 (0.4 GHz ≤ frequency &lt; 3.1 GHz) At 3 GHz ≤ setting frequency ≤ 4.2 GHz ≤1.9 (2.9 GHz ≤ frequency ≤ 4.3 GHz) At 4.2 GHz &lt; setting frequency ≤ 6 GHz ≤2.0 (4.1 GHz &lt; frequency ≤ 6.1 GHz)</p>
---------	---

# Radio Communication Test Station MT8000A Specifications

Transmission Characteristics	<p>Frequency          Setting range: 0.4 GHz to 6 GHz          Setting resolution: 1 Hz          Accuracy: Depend on accuracy of reference oscillator</p> <p>Level          Setting range          Main 1, Main 2          -110 to -10 dBm (0.4 GHz ≤ setting frequency ≤ 6 GHz)          Aux 1, Aux 2          -110 to 0 dBm (0.4 GHz ≤ setting frequency ≤ 6 GHz)          Setting resolution: 0.1 dB</p> <p>Accuracy          Main 1, Main 2          After Cal, with CW, 0.4 GHz ≤ setting frequency &lt; 3 GHz, output level ≥ -100 dBm          ±0.7 dB (typ.)          ±1.0 dB (+18°C to +28°C)          ±1.3 dB (+5°C to +40°C)          After Cal, with CW, 3 GHz ≤ setting frequency ≤ 6 GHz, output level ≥ -100 dBm          ±1.0 dB (+18°C to +28°C)          ±1.3 dB (+5°C to +40°C)          Aux 1, Aux 2          After Cal, with CW, 0.4 GHz ≤ setting frequency &lt; 3 GHz, output level ≥ -100 dBm          ±0.7 dB (typ.)          ±1.0 dB (+18°C to +28°C)          ±1.3 dB (+5°C to +40°C)          After Cal, with CW, 3 GHz ≤ setting frequency ≤ 4.2 GHz, output level ≥ -100 dBm          ±1.0 dB (+18°C to +28°C)          ±1.3 dB (+5°C to +40°C)          After Cal, with CW, 4.2 GHz &lt; setting frequency ≤ 6 GHz, output level ≥ -100 dBm          ±1.5 dB (+18°C to +28°C)          ±2.0 dB (+5°C to +40°C)</p> <p>Signal purity          Non-harmonic spurious          With CW, 0.4 GHz ≤ setting frequency &lt; 0.6 GHz, maximum output level,          setting frequency ±10 MHz (exclude &lt;0.4 GHz), exclude setting frequency ±2.5 MHz          ≤-40 dBc          With CW, 0.6 GHz ≤ setting frequency &lt; 3.3 GHz, maximum output level, non-harmonic on setting frequency ±100 MHz,          exclude setting frequency ±2.5 MHz          ≤-40 dBc          With CW, 3.3 GHz ≤ setting frequency ≤ 6 GHz, maximum output level, non-harmonic on setting frequency ±200 MHz,          exclude setting frequency ±2.5 MHz          ≤-40 dBc          With CW, 0.4 GHz ≤ setting frequency &lt; 0.6 GHz, maximum output level,          0.4 GHz ≤ non-harmonic frequency ≤ 6 GHz, exclude setting frequency ±10 MHz          ≤-30 dBc          With CW, 0.6 GHz ≤ setting frequency &lt; 3.3 GHz, maximum output level,          0.4 GHz ≤ non-harmonic frequency ≤ 6 GHz, exclude setting frequency ±100 MHz          ≤-30 dBc          With CW, 3.3 GHz ≤ setting frequency ≤ 6 GHz, maximum output level,          0.4 GHz ≤ non-harmonic frequency ≤ 6.2 GHz, exclude setting frequency ±200 MHz          ≤-30 dBc          Harmonic spurious          With CW, 0.4 GHz ≤ setting frequency ≤ 3 GHz, maximum output level          ≤-25 dBc          Maximum modulation bandwidth          20 MHz (0.4 GHz ≤ setting frequency &lt; 0.6 GHz)          200 MHz (0.6 GHz ≤ setting frequency &lt; 3.3 GHz)          400 MHz (3.3 GHz ≤ setting frequency ≤ 6 GHz)</p>
------------------------------	--

# Radio Communication Test Station MT8000A Specifications

Receiving Characteristics	<p>Frequency            Setting range: 0.4 GHz to 6 GHz            Setting resolution: 1 Hz</p> <p>Level            Maximum input level: +30 dBm, 0 VDC (0.4 GHz ≤ setting frequency ≤ 6 GHz, with CW)            Setting range: -50 to +26 dBm            Setting resolution: 0.1 dB</p> <p>Amplitude            Measurement resolution: 0.01 dB            Measurement accuracy            After Cal, with CW, 0.4 GHz ≤ setting frequency &lt; 3 GHz, measurement bandwidth is 100 MHz, at the signal equal to the setting frequency and the setting level              ±0.5 dB (Setting level ≥ -20 dBm, typical)              ±0.7 dB (Setting level ≥ -40 dBm, typical)              ±1.0 dB (Setting level ≥ -40 dBm, +18°C to +28°C)              ±1.3 dB (Setting level ≥ -50 dBm, +18°C to +28°C)            After Cal, with CW, 3 GHz ≤ setting frequency ≤ 6 GHz, measurement bandwidth is 100 MHz, at the signal equal to the setting frequency and the setting level              ±1.0 dB (Setting level ≥ -40 dBm, +18°C to +28°C)              ±1.3 dB (Setting level ≥ -50 dBm, +18°C to +28°C)</p>
---------------------------	--

## 3 GHz-12 GHz RF Sub Module MT8000A-022

### Extend RF 2.4 GHz-3 GHz MT8000A-023

### Extend RF 6 GHz-7.125 GHz MT8000A-024

General	<p>RF input/output connector            Main 1, Main 2            Connector: N (f)            Impedance: 50Ω (nom.)            VSWR              At 2.4 GHz ≤ setting frequency &lt; 3 GHz, with MT8000A-023                ≤1.7 (2.3 GHz ≤ frequency &lt; 3.1 GHz)              At 3 GHz ≤ setting frequency ≤ 6 GHz                ≤1.5 (2.9 GHz ≤ frequency ≤ 6.1 GHz)              At 6 GHz &lt; setting frequency ≤ 7.125 GHz, with MT8000A-024                ≤1.7 (5.9 GHz &lt; frequency ≤ 7.225 GHz)</p> <p>RF output connector            Aux 1, Aux 2            Connector: N (f)            Impedance: 50Ω (nom.)            VSWR              At 2.4 GHz ≤ setting frequency ≤ 4.2 GHz, with MT8000A-023                ≤1.8 (2.3 GHz ≤ frequency ≤ 4.3 GHz)              At 3 GHz ≤ setting frequency ≤ 4.2 GHz, without MT8000A-023                ≤1.8 (2.9 GHz ≤ frequency ≤ 4.3 GHz)              At 4.2 GHz &lt; setting frequency ≤ 6 GHz                ≤2.0 (4.1 GHz &lt; frequency ≤ 6.1 GHz)              At 6 GHz &lt; setting frequency ≤ 7.125 GHz, with MT8000A-024                ≤2.2 (5.9 GHz &lt; frequency ≤ 7.225 GHz)</p>
---------	--

# Radio Communication Test Station MT8000A Specifications

<p>Transmission Characteristics</p>	<p>Frequency            Setting range: 2 GHz to 12 GHz            Setting resolution: 1 Hz            Accuracy: Depend on accuracy of reference oscillator</p> <p>Level            Setting range            Main 1, Main 2            -110 to -10 dBm (2 GHz ≤ setting frequency ≤ 6 GHz)            -110 to -18 dBm (6 GHz &lt; setting frequency ≤ 12 GHz)            Aux 1, Aux 2            -110 to 0 dBm (2 GHz ≤ setting frequency ≤ 6 GHz)            -110 to -8 dBm (6 GHz &lt; setting frequency ≤ 12 GHz)            Setting resolution: 0.1 dB            Accuracy            Main 1, Main 2            After Cal, with CW, 2.4 GHz ≤ setting frequency &lt; 3 GHz, output level ≥ -100 dBm, with MT8000A-023              ±0.7 dB (typ.)              ±1.0 dB (+18°C to +28°C)              ±1.3 dB (+5°C to +40°C)            After Cal, with CW, 3 GHz ≤ setting frequency ≤ 6 GHz, output level ≥ -100 dBm              ±1.0 dB (+18°C to +28°C)              ±1.3 dB (+5°C to +40°C)            After Cal, with CW, 6 GHz &lt; setting frequency ≤ 7.125 GHz, output level ≥ -100 dBm, with MT8000A-024              ±1.3 dB (+18°C to +28°C)              ±1.6 dB (+5°C to +40°C)            Aux 1, Aux 2            After Cal, with CW, 2.4 GHz ≤ setting frequency &lt; 3 GHz, output level ≥ -100 dBm, with MT8000A-023              ±0.7 dB (typ.)              ±1.0 dB (+18°C to +28°C)              ±1.3 dB (+5°C to +40°C)            After Cal, with CW, 3 GHz ≤ setting frequency ≤ 4.2 GHz, output level ≥ -100 dBm              ±1.0 dB (+18°C to +28°C)              ±1.3 dB (+5°C to +40°C)            After Cal, with CW, 4.2 GHz &lt; setting frequency ≤ 6 GHz, output level ≥ -100 dBm              ±1.5 dB (+18°C to +28°C)              ±2.0 dB (+5°C to +40°C)            After Cal, with CW, 6 GHz &lt; setting frequency ≤ 7.125 GHz, output level ≥ -100 dBm, with MT8000A-024              ±1.5 dB (typ.)              ±1.8 dB (+18°C to +28°C)              ±2.3 dB (+5°C to +40°C)</p> <p>Signal purity            Non-harmonic spurious            With CW, maximum output level, setting frequency ±100 MHz, exclude setting frequency ±2.5 MHz              ≤ -40 dBc (2.4 GHz ≤ setting frequency ≤ 6 GHz, with MT8000A-023)              ≤ -40 dBc (3 GHz ≤ setting frequency ≤ 6 GHz, without MT8000A-023)              ≤ -40 dBc (2.4 GHz ≤ setting frequency ≤ 7.125 GHz, with MT8000A-023 and MT8000A-024)              ≤ -40 dBc (3 GHz ≤ setting frequency ≤ 7.125 GHz, without MT8000A-023, with MT8000A-024)            With CW, maximum output level, exclude setting frequency ±100 MHz              ≤ -30 dBc (2.4 GHz ≤ setting frequency ≤ 6 GHz, 2.3 GHz ≤ non-harmonic frequency ≤ 6.1 GHz, with MT8000A-023)              ≤ -30 dBc (3 GHz ≤ setting frequency ≤ 6 GHz, 2.9 GHz ≤ non-harmonic frequency ≤ 6.1 GHz, without MT8000A-023)              ≤ -30 dBc (2.4 GHz ≤ setting frequency ≤ 7.125 GHz, 2.3 GHz ≤ non-harmonic frequency ≤ 7.225 GHz, with MT8000A-023 and MT8000A-024)              ≤ -30 dBc (3 GHz ≤ setting frequency ≤ 7.125 GHz, 2.9 GHz ≤ non-harmonic frequency ≤ 7.225 GHz, without MT8000A-023, with MT8000A-024)            Maximum modulation bandwidth: 200 MHz (2 GHz ≤ setting frequency ≤ 6 GHz)              1 GHz (6 GHz &lt; setting frequency ≤ 12 GHz)</p>
<p>Receiving Characteristics</p>	<p>Frequency            Setting range: 2 GHz to 12 GHz (Center frequency setting range of measurement software)            Setting resolution: 1 Hz</p> <p>Level            Maximum input level: +35 dBm, 0 VDC (2.4 GHz ≤ setting frequency ≤ 6 GHz, with CW, with MT8000A-023)              +35 dBm, 0 VDC (3 GHz ≤ setting frequency ≤ 6 GHz, with CW, without MT8000A-023)              +30 dBm, 0 VDC (6 GHz &lt; setting frequency ≤ 12 GHz, with CW)            Setting range: -50 to +26 dBm            Setting resolution: 0.1 dB</p> <p>Amplitude            Measurement resolution: 0.01 dB            Measurement accuracy: At the signal equal to the setting frequency and the setting level            After Cal, with CW, 2.4 GHz ≤ setting frequency &lt; 3 GHz, measurement bandwidth is 100 MHz, with MT8000A-023              ±0.5 dB (Setting level ≥ -20 dBm, typ.)              ±0.7 dB (Setting level ≥ -40 dBm, typ.)              ±1.0 dB (Setting level ≥ -40 dBm, +18°C to +28°C)              ±1.3 dB (Setting level ≥ -50 dBm, +18°C to +28°C)            After Cal, with CW, 3 GHz ≤ setting frequency ≤ 6 GHz, measurement bandwidth is 100 MHz              ±1.0 dB (Setting level ≥ -40 dBm, +18°C to +28°C)              ±1.3 dB (Setting level ≥ -50 dBm, +18°C to +28°C)            After Cal, with CW, 6 GHz &lt; setting frequency ≤ 7.125 GHz, measurement bandwidth is 100 MHz, with MT8000A-024              ±1.3 dB (Setting level ≥ -40 dBm, +18°C to +28°C)              ±1.6 dB (Setting level ≥ -50 dBm, +18°C to +28°C)</p>

# Radio Communication Test Station MT8000A Specifications

## 0.4 GHz-6 GHz Multi RF Module MT8000A-031, 0.4 GHz-6 GHz Multi RF Extension MT8000A-032

General	<p>RF input/output connector Main 1, Main 2 Connector: N (f) Impedance: 50Ω (nom.) VSWR: ≤1.5 (0.4 GHz ≤ frequency ≤ 6 GHz)</p> <p>RF output connector Aux 1, Aux 2, Tx 1, Tx 2 Connector: N (f) Impedance: 50Ω (nom.) VSWR: ≤1.6 (0.4 GHz ≤ frequency ≤ 3.1 GHz) ≤1.9 (3.1 GHz &lt; frequency ≤ 4.3 GHz) ≤2.0 (4.3 GHz &lt; frequency ≤ 6.0 GHz)</p>
Transmission Characteristics	<p>Frequency Setting range: 0.4 GHz to 6.0 GHz (Frequency setting range of measurement software) Setting resolution: 1 Hz Accuracy: Depend on accuracy of reference oscillator</p> <p>Level Setting range Main 1, Main 2 -110 to -10 dBm (0.4 GHz ≤ setting frequency ≤ 6 GHz) Aux 1, Aux 2, Tx 1, Tx 2 -110 to 0 dBm (0.4 GHz ≤ setting frequency ≤ 6 GHz) Setting resolution: 0.1 dB</p> <p>Accuracy Main 1, Main 2 After Cal, with CW, 0.4 GHz ≤ setting frequency &lt; 3 GHz, Setting level ≥-100 dBm ±0.7 dB (Typ.) ±1.0 dB (+18°C to +28°C) ±1.3 dB (+5°C to +40°C) After Cal, with CW, 3 GHz ≤ setting frequency ≤ 6 GHz, Setting level ≥-100 dBm ±1.0 dB (+18°C to +28°C) ±1.3 dB (+5°C to +40°C) Aux 1, Aux 2, Tx 1, Tx 2 After Cal, with CW, 0.4 GHz ≤ setting frequency &lt; 3 GHz, Setting level ≥-100 dBm ±0.7 dB (Typ.) ±1.0 dB (+18°C to +28°C) ±1.3 dB (+5°C to +40°C) After Cal, with CW, 3 GHz ≤ setting frequency ≤ 4.2 GHz, Setting level ≥-100 dBm ±1.0 dB (+18°C to +28°C) ±1.3 dB (+5°C to +40°C) After Cal, with CW, 4.2 GHz &lt; setting frequency ≤ 6 GHz, Setting level ≥-100 dBm ±1.5 dB (+18°C to +28°C) ±2.0 dB (+5°C to +40°C)</p> <p>Signal purity Non-harmonic spurious: With CW, maximum out level ≤-40 dBc (0.4 GHz ≤ setting frequency &lt; 0.6 GHz, non-harmonic spurious within setting frequency ±10 MHz, exclude setting frequency &lt; 0.4 GHz, exclude non-harmonic spurious within setting frequency ±2.5 MHz) ≤-40 dBc (0.6 GHz ≤ setting frequency ≤ 6 GHz, non-harmonic spurious within setting frequency ±100 MHz, exclude non-harmonic spurious within setting frequency ±2.5 MHz) ≤-30 dBc (0.4 GHz ≤ setting frequency &lt; 0.6 GHz, 0.4 GHz ≤ non-harmonic spurious ≤ 6 GHz, exclude non-harmonic spurious within setting frequency ±10 MHz) ≤-30 dBc (0.6 GHz ≤ setting frequency &lt; 3.3 GHz, 0.4 GHz ≤ non-harmonic spurious ≤ 6 GHz, exclude non-harmonic spurious within setting frequency ±100 MHz) ≤-30 dBc (3.3 GHz ≤ setting frequency ≤ 6 GHz, 0.4 GHz ≤ non-harmonic spurious ≤ 6.1 GHz, exclude non-harmonic spurious within setting frequency ±100 MHz) Harmonic spurious: With CW, maximum out level ≤-25 dBc (0.4 GHz ≤ setting frequency ≤ 3 GHz)</p> <p>Maximum modulation bandwidth 20 MHz (0.4 GHz ≤ setting frequency &lt; 0.6 GHz) 200 MHz (0.6 GHz ≤ setting frequency ≤ 6 GHz)</p>
Receiving Characteristics	<p>Frequency Setting range: 0.4 GHz to 6 GHz (Frequency setting range of measurement software) Setting resolution: 1 Hz</p> <p>Level Maximum input level: +35 dBm, 0 VDC (with CW, 0.4 GHz ≤ setting frequency ≤ 6 GHz) Setting range: -50 to +26 dBm Setting resolution: 0.1 dB</p> <p>Amplitude Measurement resolution: 0.01 dB Measurement accuracy: After Cal, with CW, at the signal equal to the setting frequency and the setting level 0.4 GHz ≤ setting frequency ≤ 0.6 GHz, measurement bandwidth 10 MHz ±0.5 dB (setting level ≥-20 dBm, typ.) ±0.7 dB (setting level ≥-40 dBm, typ.) ±1.0 dB (setting level ≥-40 dBm, +18°C to +28°C) ±1.3 dB (setting level ≥-50 dBm, +18°C to +28°C) 0.6 GHz &lt; setting frequency &lt; 3 GHz, measurement bandwidth 100 MHz ±0.5 dB (setting level ≥-20 dBm, typ.) ±0.7 dB (setting level ≥-40 dBm, typ.) ±1.0 dB (setting level ≥-40 dBm, +18°C to +28°C) ±1.3 dB (setting level ≥-50 dBm, +18°C to +28°C) 3 GHz ≤ setting frequency ≤ 6 GHz, measurement bandwidth 100 MHz ±1.0 dB (setting level ≥-40 dBm, +18°C to +28°C) ±1.3 dB (setting level ≥-50 dBm, +18°C to +28°C)</p>

# Radio Communication Test Station MT8000A Specifications

## 0.4 GHz-7.125 GHz Enhanced RF Module MT8000A-033

General	<p>RF input/output connector Main 1, Main 2, Main 3, Main 4 Connector: N (J) type Impedance: 50Ω (nom.) VSWR: ≤1.7 (0.4 GHz ≤ frequency ≤ 0.6 GHz)           ≤1.5 (0.6 GHz &lt; frequency ≤ 5.0 GHz)           ≤1.9 (5.0 GHz &lt; frequency ≤ 7.6 GHz)</p> <p>RF output connector Aux 1, Aux 2, Aux 3, Aux 4 Connector: N (J) type Impedance: 50Ω (nom.) VSWR: ≤1.8 (0.4 GHz ≤ frequency ≤ 0.6 GHz)           ≤1.7 (0.6 GHz &lt; frequency ≤ 3.0 GHz)           ≤1.9 (3.0 GHz &lt; frequency ≤ 4.2 GHz)           ≤2.0 (4.2 GHz &lt; frequency ≤ 6.0 GHz)           ≤2.2 (6.0 GHz &lt; frequency ≤ 7.6 GHz)</p>
IF Input/Output Connector	<p>RF Converter B1, B2 Connector: SMA (f) Impedance: 50Ω (nom.)</p>
External Interface	<p>RF Converter A1, A2: Round multiway type connector</p>
Transmission Characteristics	<p>Frequency Setting range: 0.4 GHz to 5.0 GHz (Internal signal generator Tx-A)                   0.4 GHz to 7.125 GHz (Internal signal generator Tx-B) Setting resolution: 1 Hz (Tx-A, Tx-B) Accuracy: Depend on accuracy of reference oscillator</p> <p>Level Setting range Main 1, Main 2, Main 3, Main 4 -110 to -10 dBm (0.4 GHz ≤ frequency ≤ 7.125 GHz) Aux 1, Aux 2, Aux 3, Aux 4 -110 to 0 dBm (0.4 GHz ≤ frequency ≤ 7.125 GHz) Setting resolution: 0.1 dB Accuracy Main 1, Main 2, Main 3, Main 4 After calibration, CW, 0.4 GHz ≤ Set frequency ≤ 0.6 GHz, -100 dBm ≤ Output Level, Use of either Tx-A or Tx-B signal output, Use of both Tx-A and Tx-B signal output, Each output with a signal level difference between Tx-A and Tx-B ≤ 25 dB ±0.7 dB (Typ.) ±1.0 dB (+18°C to +28°C) ±1.4 dB (+5°C to +40°C) After calibration, CW, 0.6 GHz &lt; Set frequency ≤ 3.0 GHz, -100 dBm ≤ Output Level, Use of either Tx-A or Tx-B signal output, Use of both Tx-A and Tx-B signal output, Each output with a signal level difference between Tx-A and Tx-B ≤ 25 dB ±0.7 dB (Typ.) ±1.0 dB (+18°C to +28°C) ±1.3 dB (+5°C to +40°C) After calibration, CW, 3.0 GHz &lt; Set frequency ≤ 5.0 GHz, -100 dBm ≤ Output Level, Use of either Tx-A or Tx-B signal output, Use of both Tx-A and Tx-B signal output, Each output with a signal level difference between Tx-A and Tx-B ≤ 25 dB ±1.0 dB (+18°C to +28°C) ±1.3 dB (+5°C to +40°C) After calibration, CW, 5.0 GHz &lt; Set frequency ≤ 7.125 GHz, -100 dBm ≤ Output Level Use of either Tx-A or Tx-B signal output, Use of both Tx-A and Tx-B signal output, Each output with a signal level difference between Tx-A and Tx-B ≤ 25 dB ±1.0 dB (+18°C to +28°C) ±1.5 dB (+5°C to +40°C) Aux 1, Aux 2, Aux 3, Aux 4 After calibration, CW, 0.4 GHz ≤ Set frequency ≤ 0.6 GHz, -100 dBm ≤ Output Level Use of either Tx-A or Tx-B signal output, Use of both Tx-A and Tx-B signal output, Each output with a signal level difference between Tx-A and Tx-B ≤ 25 dB ±0.7 dB (Typ.) ±1.0 dB (+18°C to +28°C) ±1.5 dB (+5°C to +40°C) After calibration, CW, 3.0 GHz &lt; Set frequency ≤ 4.2 GHz, -100 dBm ≤ Output Level Use of either Tx-A or Tx-B signal output, Use of both Tx-A and Tx-B signal output, Each output with a signal level difference between Tx-A and Tx-B ≤ 25 dB ±1.0 dB (+18°C to +28°C) ±1.3 dB (+5°C to +40°C) After calibration, CW, 4.2 GHz &lt; Set frequency ≤ 6.0 GHz, -100 dBm ≤ Output Level Use of either Tx-A or Tx-B signal output, Use of both Tx-A and Tx-B signal output, Each output with a signal level difference between Tx-A and Tx-B ≤ 25 dB ±1.0 dB (nom.) ±1.5 dB (+18°C to +28°C) ±2.0 dB (+5°C to +40°C) After calibration, CW, 6 GHz &lt; Set frequency ≤ 7.125 GHz, -100 dBm ≤ Output Level Use of either Tx-A or Tx-B signal output, Use of both Tx-A and Tx-B signal output, Each output with a signal level difference between Tx-A and Tx-B ≤ 25 dB ±1.5 dB (Typ.) ±1.8 dB (+18°C to +28°C) ±2.3 dB (+5°C to +40°C)</p>

# Radio Communication Test Station MT8000A Specifications

<p>Transmission Characteristics (continued)</p>	<p>Signal purity Non-harmonic spurious CW, use of either Tx-A or Tx-B signal output, Max Output Level, other output levels are OFF 0.4 GHz ≤ Set frequency ≤ 0.6 GHz, 0.4 GHz ≤ Non-harmonic of Set frequency ≤ 7.125 GHz, except Set frequency within ±10 MHz ≤ -40 dBc CW, use of either Tx-A or Tx-B signal output, Max Output Level, other output levels are OFF 0.6 GHz &lt; Set frequency ≤ 7.125 GHz, 0.4 GHz ≤ Non-harmonic of Set frequency ≤ 7.125 GHz, except Set frequency within ±100 MHz ≤ -40 dBc Harmonic spurious CW, use of either Tx-A or Tx-B signal output, Max Output Level, other output levels are OFF 0.4 GHz ≤ Set frequency ≤ 3.5625 GHz ≤ -25 dBc Maximum modulation bandwidth 20 MHz (Set frequency ≤ 0.6 GHz) 400 MHz (0.6 GHz &lt; Set frequency)</p>
<p>Receiving Characteristics</p>	<p>Frequency Setting range: 0.4 GHz to 7.125 GHz Setting resolution: 1 Hz Level Maximum input level: CW, +30 dBm (0.4 GHz ≤ Set frequency ≤ 7.125 GHz), 0 VDC Setting range: -60 to +30 dBm Setting resolution: 0.1 dB Amplitude measurement Measurement resolution: 0.01 dB Measurement accuracy After calibration, CW, 0.4 GHz ≤ Set frequency ≤ 0.6 GHz, Measurement Bandwidth 10 MHz, Measured signal with the same frequency as the set frequency, Measured signal at the same level as the set level With the Main output connector selected, Total power of Tx-A and Tx-B ≤ -20 dBm ±0.5 dB (setting level ≥ -20 dBm, typ.) ±0.7 dB (setting level ≥ -40 dBm, typ.) ±1.0 dB (setting level ≥ -40 dBm, +18°C to +28°C) ±1.3 dB (setting level ≥ -50 dBm, +18°C to +28°C) ±1.6 dB (setting level ≥ -60 dBm, +18°C to +28°C) After calibration, CW, 0.6 GHz &lt; Set frequency ≤ 1.3 GHz, Measurement Bandwidth 20 MHz, Measured signal with the same frequency as the set frequency, Measured signal at the same level as the set level With the Main output connector selected, Total power of Tx-A and Tx-B ≤ -20 dBm ±0.5 dB (setting level ≥ -20 dBm, typ.) ±0.7 dB (setting level ≥ -40 dBm, typ.) ±1.0 dB (setting level ≥ -40 dBm, +18°C to +28°C) ±1.3 dB (setting level ≥ -50 dBm, +18°C to +28°C) ±1.6 dB (setting level ≥ -60 dBm, +18°C to +28°C) After calibration, CW, 1.3 GHz &lt; Set frequency ≤ 3.0 GHz, Measurement Bandwidth 100 MHz, Measured signal with the same frequency as the set frequency, Measured signal at the same level as the set level With the Main output connector selected, Total power of Tx-A and Tx-B ≤ -20 dBm ±0.5 dB (setting level ≥ -20 dBm, typ.) ±0.7 dB (setting level ≥ -40 dBm, typ.) ±1.0 dB (setting level ≥ -40 dBm, +18°C to +28°C) ±1.3 dB (setting level ≥ -50 dBm, +18°C to +28°C) ±1.6 dB (setting level ≥ -60 dBm, +18°C to +28°C) After calibration, CW, 3 GHz &lt; Set frequency ≤ 5 GHz, Measurement Bandwidth 100 MHz, Measured signal with the same frequency as the set frequency, Measured signal at the same level as the set level ±1.0 dB (setting level ≥ -40 dBm, +18°C to +28°C) ±1.3 dB (setting level ≥ -50 dBm, +18°C to +28°C) ±1.6 dB (setting level ≥ -60 dBm, +18°C to +28°C) After calibration, CW, 5 GHz &lt; Set frequency ≤ 6 GHz, Measurement Bandwidth 100 MHz, Measured signal with the same frequency as the set frequency, Measured signal at the same level as the set level ±1.0 dB (setting level ≥ -40 dBm, +18°C to +28°C) ±1.3 dB (setting level ≥ -50 dBm, +18°C to +28°C) ±1.6 dB (setting level ≥ -60 dBm, +18°C to +28°C) After calibration, CW, 6 GHz &lt; Set frequency ≤ 7.125 GHz, Measurement Bandwidth 100 MHz, Measured signal with the same frequency as the set frequency, Measured signal at the same level as the set level ±1.0 dB (setting level ≥ -40 dBm, +18°C to +28°C) ±1.3 dB (setting level ≥ -50 dBm, +18°C to +28°C) Linearity After calibration, CW, 0.4 GHz ≤ Set frequency ≤ 0.6 GHz, Set level ≥ -10 dBm, Measurement Bandwidth 100 MHz, Measured signal with the same frequency as the set frequency, Measured signal up to the level 40 dB lower than the set level ±0.15 dB (Typ.) After calibration, CW, 0.6 GHz &lt; Set frequency ≤ 7.125 GHz, Set level ≥ -10 dBm, Measurement Bandwidth 20 MHz, With the Main output connector selected, Total power of Tx-A and Tx-B ≤ -20 dBm, Measured signal with the same frequency as the set frequency, Measured signal up to the level 40 dB lower than the set level ±0.15 dB (Typ.) After calibration, CW, 0.6 GHz &lt; Set frequency ≤ 7.125 GHz, Set level ≥ -10 dBm, Measurement Bandwidth 100 MHz, Measured signal with the same frequency as the set frequency, Measured signal up to the level 20 dB lower than the set level ±0.15 dB (Typ.) Measured signal up to the level 30 dB lower than the set level ±0.34 dB (Typ.)</p>

# Radio Communication Test Station MT8000A Specifications

## Peripherals

### 28 GHz RF Converter MA80001A

RF Input/Output Connector	Port 1, Port 2 Connector: K (m) Impedance: 50Ω (nom.) VSWR (when transmitted): ≤2.5 (23.75 GHz ≤ frequency ≤ 30 GHz) VSWR (when received): ≤2.5 (23.45 GHz ≤ frequency ≤ 30.3 GHz)	
Transmission Characteristics	Frequency Setting range: 24.25 GHz to 29.5 GHz (Center frequency setting range of measurement software) Setting resolution: 1 Hz Accuracy: Depend on accuracy of MT8000A reference oscillator Level Setting range: -90 to +5 dBm Setting resolution: 0.1 dB Accuracy: ±1.5 dB (+18°C to +28°C, after Cal, with CW) Signal purity Non-harmonic spurious With CW, maximum output level ≤-40 dBc (non-harmonic on setting frequency ±500 MHz, non-harmonic, exclude setting frequency ±50 MHz) ≤-30 dBc (23.75 GHz ≤ non-harmonic frequency ≤ 30 GHz, exclude setting frequency within ±500 MHz and -4500 MHz) Maximum modulation bandwidth: 1 GHz	
Receiving Characteristics	Frequency Setting range: 24.25 GHz to 29.5 GHz (Center frequency setting range of measurement software) Setting resolution: 1 Hz Level Maximum input level: +20 dBm, 0 VDC (with CW) Setting range: -70 to +5 dBm Setting resolution: 0.1 dB Amplitude Measurement resolution: 0.01 dB Measurement accuracy: At the signal equal to the setting frequency and the setting level After Cal, with CW, 24.25 GHz ≤ setting frequency ≤ 29.5 GHz, measurement bandwidth 100 MHz, +18°C to +28°C ±1.5 dB (-50 dBm ≤ setting level ≤ +5 dBm) ±2.5 dB (-70 dBm ≤ setting level < -50 dBm)	
IF Input/Output Connector	Connect to MT8000A: B Connector: N (f) Impedance: 50Ω (nom.)	
External Control Connector	Round multiway type connector	
DC Input Connector	Voltage: 12 VDC Current: ≤3 A	
Dimensions and Mass	Dimensions: 92 (W) × 175 (H) × 260 (D) mm (excluding projections) Mass: ≤6 kg	
Environmental Conditions	Operating temperature range: +5°C to +40°C (without condensation) Storage temperature range: -20°C to +71°C (without condensation)	
CE	EMC	2014/30/EU, EN61326-1, EN61000-3-2
	LVD	2014/35/EU, EN61010-1
	RoHS	2011/65/EU, (EU) 2015/863, EN IEC 63000: 2018
UKCA	EMC	S.I. 2016 No.1091, EN 61326-1, EN61000-3-2
	LVD	S.I. 2016 No.1101, EN 61010-1
	RoHS	S.I. 2012 No.3032, EN IEC 63000:2018



# Radio Communication Test Station MT8000A Specifications

## Peripherals

### 39 GHz RF Converter MA80002A

RF Input/Output Connector	Port 1, Port 2 Connector: K (m) Impedance: 50Ω (nom.) VSWR: ≤2.9 (36.2 GHz ≤ frequency ≤ 40.0 GHz)	
Transmission Characteristics	Frequency Setting range: 37.0 GHz to 42.5 GHz (Center frequency setting range of measurement software) Setting resolution: 1 Hz Accuracy: Depend on accuracy of MT8000A reference oscillator Level Setting range: -90 to +5 dBm Setting resolution: 0.1 dB Accuracy: ±1.5 dB (typ., after Cal, with CW, 37.0 GHz ≤ setting frequency ≤ 40.0 GHz) ±2.0 dB (+18°C to +28°C, after Cal, with CW, 37.0 GHz ≤ setting frequency ≤ 40.0 GHz) Signal purity Non-harmonic spurious With CW, maximum output level, 37.0 GHz ≤ setting frequency ≤ 40.0 GHz ≤-40 dBc (non-harmonic on setting frequency ±500 MHz, exclude non-harmonic frequency >40.0 GHz and setting frequency ±50 MHz) ≤-30 dBc (36.5 GHz ≤ non-harmonic frequency ≤ 40.0 GHz, exclude setting frequency ±500 MHz) Maximum modulation bandwidth: 1 GHz	
Receiving Characteristics	Frequency Setting range: 37.0 GHz to 42.5 GHz (Center frequency setting range of measurement software) Setting resolution: 1 Hz Level Maximum input level: +17 dBm, 0 VDC (with CW) Setting range: -70 to +5 dBm Setting resolution: 0.1 dB Amplitude Measurement resolution: 0.01 dB Measurement accuracy: At the signal equal to the setting frequency and the setting level After Cal, with CW, 37.0 GHz ≤ setting frequency ≤ 40.0 GHz, measurement bandwidth 100 MHz ±1.5 dB (-50 dBm ≤ setting level ≤ +5 dBm, typ.) ±2.0 dB (-70 dBm ≤ setting level < -50 dBm, typ.) ±2.0 dB (-50 dBm ≤ setting level ≤ +5 dBm, +18°C to +28°C) ±2.5 dB (-70 dBm ≤ setting level < -50 dBm, +18°C to +28°C)	
IF Input/Output Connector	Connect to MT8000A: B Connector: N (f) Impedance: 50Ω (nom.)	
External Control Connector	Round multiway type connector	
DC Input Connector	Voltage: 12 VDC Current: ≤4 A	
Dimensions and Mass	Dimensions: 92 (W) × 175 (H) × 304 (D) mm (excluding projections) Mass: ≤6 kg	
Environmental Conditions	Operating temperature range: +5°C to +40°C (without condensation) Storage temperature: -20°C to +71°C (without condensation)	
CE	EMC	2014/30/EU, EN61326-1, EN61000-3-2
	LVD	2014/35/EU, EN61010-1
	RoHS	2011/65/EU, (EU) 2015/863, EN IEC 63000: 2018
UKCA	EMC	S.I. 2016 No.1091, EN 61326-1, EN61000-3-2
	LVD	S.I. 2016 No.1101, EN 61010-1
	RoHS	S.I. 2012 No.3032, EN IEC 63000:2018

# Radio Communication Test Station MT8000A Specifications

## Peripherals

### Multiband RF Converter MA80003A

RF Input/Output Connector	Port 1, Port 2 Connector: V (m) Impedance: 50Ω (nom.) VSWR: ≤2.5 (22.65 GHz ≤ frequency ≤ 31.1 GHz) ≤2.9 (35.4 GHz ≤ frequency ≤ 43.5 GHz) ≤2.9 (43.5 GHz < frequency ≤ 45.1 GHz, typ.)	
Transmission Characteristics	Frequency Setting range: 24.25 GHz to 29.5 GHz, 37.0 GHz to 43.5 GHz Setting resolution: 1 Hz Accuracy: Depend on accuracy of MT8000A reference oscillator Level Setting range: -70 to +15 dBm Setting resolution: 0.1 dB Accuracy: After Cal, with CW, Setting level ≤ ±10 dBm ±1.5 dB (24.25 GHz ≤ setting frequency ≤ 29.5 GHz, +18°C to +28°C) ±1.5 dB (37.0 GHz ≤ setting frequency ≤ 40.0 GHz, typ.) ±2.0 dB (37.0 GHz ≤ setting frequency ≤ 40.0 GHz, +18°C to +28°C) ±1.5 dB (40.0 GHz < setting frequency ≤ 43.5 GHz, typ.) ±2.0 dB (40.0 GHz < setting frequency ≤ 43.5 GHz, +18°C to +28°C) Signal purity Non-harmonic spurious: With CW, Setting level = +10 dBm In-band Specification: ≤-40 dBc (non-harmonic on setting frequency ±500 MHz, exclude setting frequency ±500 MHz and non-harmonic frequency < 24.25 GHz, 29.5 GHz < non-harmonic frequency < 37.0 GHz and non-harmonic frequency > 43.5 GHz) Specification for interference signal source: ≤-37 dBc (non-harmonic on setting frequency ±1.5 GHz, exclude setting frequency ±500 MHz and non-harmonic frequency < 24.25 GHz, 29.5 GHz < non-harmonic frequency < 37.0 GHz and non-harmonic frequency > 43.5 GHz) Out-of-band Specification: ≤-30 dBc (24.25 GHz ≤ setting frequency ≤ 29.5 GHz, 24.25 GHz ≤ non-harmonic frequency ≤ 29.5 GHz and 37.0 GHz ≤ non-harmonic frequency ≤ 43.5 GHz, exclude setting frequency ±1.5 GHz, setting frequency - 4.5 GHz ±10 MHz and setting frequency + 4.5 GHz ±10 MHz) ≤-30 dBc (37.0 GHz ≤ setting frequency ≤ 43.5 GHz, 24.25 GHz ≤ non-harmonic frequency ≤ 29.5 GHz and 37.0 GHz ≤ non-harmonic frequency ≤ 43.5 GHz, exclude setting frequency ±1.5 GHz) Maximum modulation bandwidth: 1 GHz	
Receiving Characteristics	Frequency Setting range: 24.25 GHz to 29.5 GHz, 37.0 GHz to 43.5 GHz Setting resolution: 1 Hz Level Maximum input level: +20 dBm, 0 VDC (with CW) Setting range: -70 to +10 dBm Setting resolution: 0.1 dB Amplitude Measurement resolution: 0.01 dB Measurement accuracy: After Cal, with CW, measurement bandwidth 100 MHz, at the signal equal to the setting frequency and the setting level 24.25 GHz ≤ setting frequency ≤ 29.5 GHz ±1.0 dB (-50 dBm ≤ setting level ≤ +10 dBm, typ.) ±2.0 dB (-70 dBm ≤ setting level < -50 dBm, typ.) ±1.5 dB (-50 dBm ≤ setting level ≤ +10 dBm, +18°C to +28°C) ±2.5 dB (-70 dBm ≤ setting level < -50 dBm, +18°C to +28°C) 37.0 GHz ≤ setting frequency ≤ 40.0 GHz ±1.5 dB (-50 dBm ≤ setting level ≤ +10 dBm, typ.) ±2.0 dB (-70 dBm ≤ setting level < -50 dBm, typ.) ±2.0 dB (-50 dBm ≤ setting level ≤ +10 dBm, +18°C to +28°C) ±2.5 dB (-70 dBm ≤ setting level < -50 dBm, +18°C to +28°C) 40.0 GHz ≤ setting frequency ≤ 43.5 GHz ±1.5 dB (-50 dBm ≤ setting level ≤ +10 dBm, typ.) ±2.0 dB (-65 dBm ≤ setting level < -50 dBm, typ.) ±2.0 dB (-50 dBm ≤ setting level ≤ +10 dBm, +18°C to +28°C) ±2.5 dB (-65 dBm ≤ setting level < -50 dBm, +18°C to +28°C)	
IF Input/Output Connector	Connector: N (f) Impedance: 50Ω (nom.)	
External Control Connector	Round multiway type connector	
DC Input Connector	Voltage: 18 VDC Current: ≤5.5 A	
Dimensions and Mass	Dimensions: 83 (W) × 175 (H) × 304 (D) mm (excluding projections) Mass: ≤6 kg	
Environmental Conditions	Operating temperature range: +5°C to +45°C (without condensation) Storage temperature range: -20°C to +71°C (without condensation)	
CE	EMC	2014/30/EU, EN61326-1, EN61000-3-2
	LVD	2014/35/EU, EN61010-1
	RoHS	2011/65/EU, (EU) 2015/863, EN IEC 63000:2018
UKCA	EMC	S.I. 2016 No.1091, EN 61326-1, EN61000-3-2
	LVD	S.I. 2016 No.1101, EN 61010-1
	RoHS	S.I. 2012 No.3032, EN IEC 63000:2018

See **OTA Product Catalog** for detailed information of Shield Box MA8161A, RF Chamber MA8171A and CATR Anechoic chamber MA8172A.

# Radio Communication Test Station MT8000A Ordering Information

Please specify the model/order number, name and quantity when ordering.

The names listed in the chart below are Order Names. The actual name of the item may differ from the Order Name.

Model/Order No.	Name
MT8000A	<b>Main Frame</b> Radio Communication Test Station
J1211 J1440A W3955AE MX800000A	<b>Standard Accessories</b> Power Cord (3.0 m, 100 V, 3 core) : 1 pc LAN Cable : 1 pc MT8000A Operation Manual (DVD) : 1 pc Platform Software
MT8000A-001 MT8000A-009 MT8000A-011 MT8000A-012 MT8000A-020 MT8000A-021 MT8000A-022 MT8000A-023 MT8000A-024 MT8000A-031 MT8000A-032 MT8000A-033	<b>Options</b> Control Module Multi-box Data Connection Baseband Module Data Test Module RF Base Module 0.4 GHz-6 GHz RF Sub Module 3 GHz-12 GHz RF Sub Module Extend RF 2.4 GHz-3 GHz Extend RF 6 GHz-7.125 GHz 0.4 GHz-6 GHz Multi RF Module 0.4 GHz-6 GHz Multi RF Extension 0.4 GHz-7.125 GHz Enhanced RF Module
MA80001A MA80002A MA80003A J1771A J1771B J1879B J1772A J1772B	<b>Converter</b> 28 GHz RF Converter 39 GHz RF Converter Multiband RF Converter Coaxial Cord (N-N, 1.0 m) Coaxial Cord (N-N, 3.0 m) Coaxial Cord (N-SMA, 3.0 m) Control Cable, 1.0 m Control Cable, 3.0 m
ML2437A MA2444D MA2445D 41KC-10 J0004 J0008 K222B Z1974A	<b>Correction Equipments for OTA Measurement</b> Power Meter Power Sensor Power Sensor 10 dB Attenuator COAXIAL ADAPTOR GPIB CABLE, 2.0M Adaptor Reference Antenna
MT8821C MT8821C-008 MX882112C MX882112C-010 MX882113C MX882113C-010 J1802A MD8430A MD8430A-005 MD8430A-035 MD8430A-060 MD8430A-061 MD8430A-064 MD8430A-086 MD8430A-SS135 MD8430A-SS136	<b>Measurement Hardware for NSA</b> Radio Communication Analyzer LTE Measurement Hardware LTE FDD Measurement Software LTE FDD NSA for 5G Anchor LTE TDD Measurement Software LTE TDD NSA for 5G Anchor Sync Cable Signalling Tester Extended Frequency Range to 3.8 GHz Hardware2 LTE Enhanced Test Mode I(ETM) LTE FDD Option LTE TDD Option LTE Anchor For 5G NSA Option Ciphering Option 1 Year Support Service for LTE FDD (ETM) 1 Year Support Service for LTE TDD (ETM)
Z2017F Z2035B Z1320F Z1320G MT8000A-AK001 MT8000A-AK002 MT8000A-AK003 Z1591A Z2023A G0408A J1875A Z1993A J0127A J1398A J1440A J1773A J1798A Z2032A	<b>Application Parts</b> Standard PC Standard PC for SSNR (with monitor) Standard PC for RTD (with monitor) Standard PC for RTD (with monitor) Fading Control PC IP Test Server PC IP Test Server PC USB Dongle (Protocol) USB Dongle (SmartStudio NR) 10 Gig Ethernet SR 850 nm SFP+ Optical cable MM LC/PC to LC/PC 3 m Duplex Optical Connector Cleaner (MPO) COAXIAL CORD, 1.0M N-SMA ADAPTOR LAN Cable AUX Conversion Adapter GPIB-USB-HS+ Reference Antenna

Model/Order No.	Name
	<b>Software Options</b>
MX800010A MX800010A-001 MX800010A-002 MX800010A-003 MX800010A-004 MX800010A-007 MX800010A-008 MX800010A-009 MX800010A-010 MX800010A-011 MX800010A-012 MX800010A-015 MX800010A-024 MX800010A-026 MX800010A-031 MX800010A-032 MX800010A-033 MX800010A-034 MX800010A-035 MX800010A-036 MX800010A-037 MX800010A-038 MX800010A-041 MX800010A-042 MX800010A-043 MX800010A-044 MX800010A-045 MX800010A-046 MX800010A-047 MX800010A-048 MX800010A-051 MX800010A-052 MX800010A-053 MX800010A-054 MX800010A-061 MX800010A-062 MX800010A-063 MX800010A-064 MX800010A-070 MX800010A-071 MX800010A-072 MX800010A-073 MX800010A-074 MX800010A-081 MX800030A MX800030A-001 MX800030A-002 MX800030A-003 MX800030A-004 MX800030A-005 MX800030A-006 MX800030A-007 MX800030A-008 MX800030A-009 MX800030A-010 MX800030A-011 MX800030A-014 MX800030A-015 MX800030A-021 MX800030A-025 MX800030A-026 MX800030A-027 MX800030A-028 MX800030A-031 MX800030A-032 MX800030A-033	NR TDD Measurement Software NR TDD SA Call Processing Software NR TDD OTA Measurement Software NR IP Data Transfer NR IMS Registration NR TDD Sub-6 GHz Measurement NR TDD mmWave Measurement NR FDD Measurement NR Joint CA Measurement for sub-6 GHz NR FR1 + FR2 Interworking Measurement NR Supplementary Uplink Measurement NR FR1 RedCap Measurement NR BW 200 MHz Per Cell EIS-CDF Optimization using Machine Learning NR TDD DL 2x2 MIMO Up To Total BW 100 MHz NR TDD DL 2x2 MIMO Up To Total BW 200 MHz NR TDD DL 2x2 MIMO Up To Total BW 400 MHz NR TDD DL 2x2 MIMO Up To Total BW 600 MHz NR TDD DL 2x2 MIMO Up To Total BW 800 MHz NR TDD DL 4x4 MIMO Up To Total BW 100 MHz NR TDD DL 4x4 MIMO Up To Total BW 200 MHz NR TDD DL 4x4 MIMO Up To Total BW 400 MHz NR TDD DL 2CA For Rx Measurement NR TDD DL 3CA For Rx Measurement NR TDD DL 4CA For Rx Measurement NR TDD DL 5CA For Rx Measurement NR TDD DL 6CA For Rx Measurement NR TDD DL 7CA For Rx Measurement NR TDD DL 8CA For Rx Measurement NR TDD DL 9CA For Rx Measurement NR TDD UL 2x2 MIMO Up To Total BW 100 MHz NR TDD UL 2x2 MIMO Up To Total BW 200 MHz NR TDD UL 2x2 MIMO Up To Total BW 400 MHz NR TDD UL 2x2 MIMO Up To Total BW 600 MHz NR TDD UL 2CA For Tx Measurement NR TDD UL 3CA For Tx Measurement NR TDD UL 4CA For Tx Measurement NR TDD UL 5CA For Tx Measurement LTE anchor Call Processing Software LTE Trx Measurement LTE DL 2 to 4CA LTE UL 2CA LTE DL 2x2/4x4 MIMO NR TDD DL 2x2 MIMO Up To Total BW 1000 MHz NR Protocol Platform Software NR TDD Platform NR FDD Platform Ciphering Internal Server 5G SA Protocol NR SDAP NR FDD/TDD Joint CA NR FR1+FR2 DC Protocol NR FR1+FR2 CA Protocol RF/Fading Driver For Multiple box Over 10 Gbps IP Throughput NR UL Configured Grant Type1/2 NR DL Semi-Persistent Scheduling NR Supplementary Uplink 2Step RACH Cross Carrier Scheduling For DC/CA Enh. Wake Up Indication For Power Saving Dual Active Protocol Stack Handover For Mobility Enh. NR DL 2x2 MIMO BW 50 MHz Per Cell NR DL 2x2 MIMO BW 100 MHz Per Cell NR DL 2x2 MIMO BW 200 MHz Per Cell

## Radio Communication Test Station MT8000A Ordering Information

Model/Order No.	Name
MX800030A-035	NR DL 4x4 MIMO BW 50 MHz Per Cell
MX800030A-036	NR DL 4x4 MIMO BW 100 MHz Per Cell
MX800030A-041	NR UL 2x2 MIMO BW 50 MHz Per Cell
MX800030A-042	NR UL 2x2 MIMO BW 100 MHz Per Cell
MX800030A-043	NR UL 2x2 MIMO BW 200 MHz Per Cell
MX800030A-051	NR DL 2CA For Protocol
MX800030A-052	NR DL 3CA For Protocol
MX800030A-053	NR DL 4CA For Protocol
MX800030A-054	NR DL 5CA For Protocol
MX800030A-055	NR DL 6CA For Protocol
MX800030A-056	NR DL 7CA For Protocol
MX800030A-057	NR DL 8CA For Protocol
MX800030A-058	NR DL 9CA For Protocol
MX800030A-059	NR DL 10CA For Protocol
MX800030A-061	NR UL 2CA For Protocol
MX800030A-062	NR UL 3CA For Protocol
MX800030A-063	NR UL 4CA For Protocol
MX800030A-071	Digital IQ Basic For Protocol
MX800031A	NR Fading Basic
MX800031A-001	NR Fading 2x2 MIMO
MX800031A-002	NR Fading 4x2/4x4 MIMO
MX800031A-003	NR Fading 2CA-4CA
MX800031A-004	NR Fading 5CA-8CA
MX800031A-005	NR Fading 8x2/8x4 MIMO
MX800032A	LTE Protocol Platform Software
MX800032A-001	LTE Anchor For Protocol
MX800032A-002	LTE Advance Features
MX800032A-010	LTE RF/Fading Driver For Multiple box
MX800033A	LTE Fading Basic
MX800050A	Rapid Test Designer Platform (RTD)
MX800050A-001	5G NSA Framework For RTD
MX800050A-002	RTD LL/L3 Procedure Libraries (5G)
MX800050A-003	Core LTE Framework For RTD
MX800050A-004	UTRAN/GERAN Framework For RTD
MX800050A-005	IMS Framework For RTD
MX800050A-006	IoT Framework For RTD
MX800050A-007	LTE-A Framework For RTD
MX800050A-008	LTE-A Pro Framework For RTD
MX800050A-009	LTE MIMO Framework For RTD
MX800050A-010	LTE Unlicensed Framework For RTD
MX800050A-011	LTE/UTRAN/GERAN Fading Library For RTD
MX800050A-012	5G Fading Library
MX800050A-013	5G SA Framework For RTD
MX800050A-020	5G NR Advanced Framework For RTD
MX800050A-021	5G NE-DC Framework For RTD
MX800050A-025	5G R17 RedCap Framework For RTD
MX800050A-026	5G R17 Small Data Transmission For RTD
MX800050A-040	RTD Test Creation and Editing Tools
MX800050A-041	RTD Test Execution Tools
MX800050A-042	RTD Protocol Analyzer
MX800050A-051	RTD Floating (Server Based) License
MX800050A-052	Modem Log Converter For Qualcomm
MX800050A-055	SMIT Advanced Features
MX800060A	Control Software
MX800060A-001	NSA Framework For L1/L2 Testing
MX800060A-013	SA Framework For L1/L2 Testing
MX800070A	SmartStudio NR
MX800070A-001	5G NSA Option
MX800070A-002	5G SA Option
MX800070A-003	LTE Core Option
MX800070A-004	5G Core Option
MX800070A-007	LTE Control for MT8000A
MX800070A-011	NR TDD Option
MX800070A-012	NR FDD Option
MX800070A-013	SDAP Option
MX800070A-014	NR FR1+FR2 Inter-working Option

Model/Order No.	Name
MX800070A-030	NR DL 2x2 MIMO BW 100 MHz Per Cell
MX800070A-035	NR DL 4x4 MIMO BW 100 MHz Per Cell
MX800070A-040	NR UL 2x2 MIMO BW 100 MHz Per Cell
MX800070A-050	NR DL 2CA Option
MX800070A-051	NR DL 3CA Option
MX800070A-052	NR DL 4CA Option
MX800070A-053	NR DL 6CA Extension Option
MX800070A-054	NR DL 8CA Extension Option
MX800070A-060	NR UL 2CA Option
MX800070A-061	NR UL 3CA Option
MX800070A-062	NR UL 4CA Option
MX800070A-063	NR UL 5CA Option
MX800070A-070	LTE DL 2x2 MIMO Option
MX800070A-071	LTE DL 4x4 MIMO Option
MX800070A-072	LTE LAA Option
MX800070A-073	LTE 2CA Option
MX800070A-074	LTE 3CA Option
MX800070A-080	IMS Server Option
MX800070A-081	IMS Script Option
MX800070A-082	RTP Control Option
MX800070A-083	IMS Log Import Option
MX800070A-090	NR Neighbour Cell List
MX800071A	SmartStudio NR IP Performance
MX800071A-001	5G NSA Option
MX800071A-002	5G SA Option
MX800071A-003	LTE Core Option
MX800071A-004	5G Core Option
MX800071A-007	LTE Control for MT8000A
MX800071A-011	NR TDD Option
MX800071A-012	NR FDD Option
MX800071A-030	NR DL 2x2 MIMO BW 100 MHz Per Cell
MX800071A-035	NR DL 4x4 MIMO BW 100 MHz Per Cell
MX800071A-040	NR UL 2x2 MIMO BW 100 MHz Per Cell
MX800071A-050	NR DL 2CA Option
MX800071A-051	NR DL 3CA Option
MX800071A-052	NR DL 4CA Option
MX800071A-060	NR UL 2CA Option
MX800071A-070	LTE DL 2x2 MIMO Option
MX800071A-071	LTE DL 4x4 MIMO Option
MX800071A-072	LTE LAA Option
MX800071A-073	LTE 2CA Option
MX800071A-074	LTE 3CA Option
MX800071A-075	LTE 4CA Option
MX800071A-076	LTE 5CA Option
MX800071A-077	LTE 6CA Option
MX800071A-078	LTE 7CA Option
MX800077A	LTE Platform Software for SmartStudio
MX800078A	LTE/NR Platform Software for SmartStudio
MX800079A	NR Platform Software for SmartStudio

## Radio Communication Test Station MT8000A Ordering Information

Model/Order No.	Name
	<b>Support Services</b>
MX800010A-SS101	5G NR RF Measurement Support Service (Per Year)
MX800010A-SS102	5G NR RF OTA Measurement Support Service (Per Year)
MX800050A-SS100	RTD Support Service (Per Year)
MX800050A-SS101	5G NSA Support Service (Per Year)
MX800050A-SS103	LTE Support Service (Per Year)
MX800050A-SS104	UTRAN/GERAN Support Service (Per Year)
MX800050A-SS105	IMS Support Service (Per Year)
MX800050A-SS106	IoT Support Service (Per Year)
MX800050A-SS107	LTE-A Support Service (Per Year)
MX800050A-SS108	LTE-A Pro Support Service (Per Year)
MX800050A-SS109	MIMO Support Service (Per Year)
MX800050A-SS110	LTE Unlicensed Support Service (Per Year)
MX800050A-SS111	LTE/UTRAN/GERAN Fading Support Service (Per Year)
MX800050A-SS112	5G Fading Support Service
MX800050A-SS113	5G SA Support Service (Per Year)
MX800050A-SS120	5G NR Advanced Support Service (Per Year)
MX800050A-SS121	5G NE-DC Support Service (Per Year)
MX800050A-SS125	5G R17 RedCap Support Service (Per Year)
MX800050A-SS126	5G R17 Small Data Transmission Support Service (Per Year)
MX800050A-SS152	Modem Log Converter For Qualcomm Support Service (Per Year)
MX800050A-SS155	SMIT Advanced Features Support Service (Per Year)
MX800060A-SS100	Control Software Support Service (Per Year)
MX800060A-SS101	NSA Framework Support Service (Per Year)
MX800060A-SS113	SA Framework Support Service (Per Year)
MX800070A-SS110	SmartStudio NR Support Service (Per Year)
MX800070A-TS181	MX800070A-081 1 Year Technical Support Service
MX800071A-SS110	SmartStudio NR IP Performance Support Service (Per Year)
	<b>Term License</b>
MX800030A-TL000	NR Protocol Platform Software
MX800030A-TL001	NR TDD Platform
MX800030A-TL002	NR FDD Platform
MX800030A-TL003	Ciphering
MX800030A-TL004	Internal Server
MX800030A-TL005	5G SA Protocol
MX800030A-TL006	NR SDAP
MX800030A-TL007	NR FDD/TDD Joint CA
MX800030A-TL008	NR FR1+FR2 DC Protocol
MX800030A-TL009	NR FR1+FR2 CA Protocol
MX800030A-TL010	RF/Fading Driver For Multiple box
MX800030A-TL011	Over 10 Gbps IP Throughput
MX800030A-TL014	NR UL Configured Grant Type1/2
MX800030A-TL015	NR DL Semi-Persistent Scheduling
MX800030A-TL025	2Step RACH
MX800030A-TL026	Cross Carrier Scheduling For DC/CA Enh.
MX800030A-TL027	Wake Up Indication For Power Saving
MX800030A-TL028	Dual Active Protocol Stack Handover For Mobility Enh.
MX800030A-TL031	NR DL 2x2 MIMO BW 50 MHz Per Cell
MX800030A-TL032	NR DL 2x2 MIMO BW 100 MHz Per Cell
MX800030A-TL033	NR DL 2x2 MIMO BW 200 MHz Per Cell
MX800030A-TL035	NR DL 4x4 MIMO BW 50 MHz Per Cell
MX800030A-TL036	NR DL 4x4 MIMO BW 100 MHz Per Cell
MX800030A-TL041	NR UL 2x2 MIMO BW 50 MHz Per Cell
MX800030A-TL042	NR UL 2x2 MIMO BW 100 MHz Per Cell
MX800030A-TL043	NR UL 2x2 MIMO BW 200 MHz Per Cell
MX800030A-TL051	NR DL 2CA For Protocol
MX800030A-TL052	NR DL 3CA For Protocol
MX800030A-TL053	NR DL 4CA For Protocol
MX800030A-TL054	NR DL 5CA For Protocol
MX800030A-TL055	NR DL 6CA For Protocol
MX800030A-TL056	NR DL 7CA For Protocol
MX800030A-TL057	NR DL 8CA For Protocol
MX800030A-TL058	NR DL 9CA For Protocol
MX800030A-TL059	NR DL 10CA For Protocol

Model/Order No.	Name
MX800030A-TL061	NR UL 2CA For Protocol
MX800030A-TL062	NR UL 3CA For Protocol
MX800030A-TL063	NR UL 4CA For Protocol
MX800032A-TL000	LTE Protocol Platform Software
MX800032A-TL001	LTE Anchor For Protocol
MX800032A-TL002	LTE Advance Features
MX800032A-TL010	LTE RF/Fading Driver For Multiple Box
MX800050A-TL001	5G NSA Framework For RTD (3 months)
MX800050A-TL002	RTD LL/L3 Procedure Libraries (5G) (3 months)
MX800050A-TL003	Core LTE Framework For RTD (3 months)
MX800050A-TL004	UTRAN/GERAN Framework For RTD (3 months)
MX800050A-TL005	IMS Framework For RTD (3 months)
MX800050A-TL006	IoT Framework For RTD (3 months)
MX800050A-TL007	LTE-A Framework For RTD (3 months)
MX800050A-TL008	LTE-A Pro Framework For RTD (3 months)
MX800050A-TL009	LTE MIMO Framework For RTD (3 months)
MX800050A-TL010	LTE Unlicensed Framework For RTD (3 months)
MX800050A-TL013	5G SA Framework For RTD (3 months)
MX800050A-TL020	5G NR Advanced Framework For RTD (3 months)
MX800050A-TL021	5G NE-DC Framework For RTD (3 months)
MX800050A-TL025	5G R17 RedCap Framework For RTD (3 months)
MX800050A-TL026	5G R17 Small Data Transmission For RTD (3 months)
MX800050A-TL040	RTD Test Creation and Editing Tools (3 months)
MX800050A-TL041	RTD Test Execution Tools (3 months)
MX800050A-TL042	RTD Protocol Analyser (3 months)
MX800050A-TL052	Modem Log Converter For Qualcomm (3 months)
MX800050A-TL055	SMIT Advanced Features (3 months)
MX800050A-SS000	RTD Support Service (3 months)
MX800050A-SS001	5G NSA Support Service (3 months)
MX800050A-SS003	LTE Support Service (3 months)
MX800050A-SS004	UTRAN/GERAN Support Service (3 months)
MX800050A-SS005	IMS Support Service (3 months)
MX800050A-SS006	IoT Support Service (3 months)
MX800050A-SS007	LTE-A Support Service (3 months)
MX800050A-SS008	LTE-A Pro Support Service (3 months)
MX800050A-SS009	MIMO Support Service (3 months)
MX800050A-SS010	LTE Unlicensed Support Service (3 months)
MX800050A-SS013	5G SA Support Service (3 months)
MX800050A-SS020	5G NR Advanced Support Service (3 months)
MX800050A-SS021	5G NE-DC Support Service (3 months)
MX800050A-SS025	5G R17 RedCap Support Service (3 months)
MX800050A-SS026	5G R17 Small Data Transmission Support Service (3 months)
MX800050A-SS052	Modem Log Converter For Qualcomm Support Service (3 months)
MX800050A-SS055	SMIT Advanced Features Support Service (3 months)
	<b>Warranty Services</b>
MT8000A-ES210	2 Years Extended Warranty Service
MT8000A-ES310	3 Years Extended Warranty Service
MT8000A-ES510	5 Years Extended Warranty Service
MA80001A-ES210	2 Years Extended Warranty Service
MA80001A-ES310	3 Years Extended Warranty Service
MA80001A-ES510	5 Years Extended Warranty Service
MA80002A-ES210	2 Years Extended Warranty Service
MA80002A-ES310	3 Years Extended Warranty Service
MA80002A-ES510	5 Years Extended Warranty Service
MA80003A-ES210	2 Years Extended Warranty Service
MA80003A-ES310	3 Years Extended Warranty Service
MA80003A-ES510	5 Years Extended Warranty Service

# Radio Communication Test Station MT8000A Ordering Information

## Related Products



Radio Communication Analyzer  
MT8821C



Signalling Tester  
MD8430A



Signalling Tester  
MD8475B



Shield Box  
MA8161A



RF Chamber  
MA8171A



CATR Anechoic Chamber  
MA8172A



Butler Matrix 8x8  
(0.6 GHz-7.125 GHz)  
MA8118A

**Note:**

---

- **United States**

- **Anritsu Americas Sales Company**

450 Century Parkway, Suite 190, Allen, TX 75013 U.S.A.  
Phone: +1-800-Anritsu (1-800-267-4878)

- **Canada**

- **Anritsu Electronics Ltd.**

- **Americas Sales and Support**

450 Century Parkway, Suite 190, Allen, TX 75013 U.S.A.  
Phone: +1-800-Anritsu (1-800-267-4878)

- **Brazil**

- **Anritsu Eletronica Ltda.**

Praça Amadeu Amaral, 27 - 1 Andar  
01327-010 - Bela Vista - Sao Paulo - SP, Brazil  
Phone: +55-11-3283-2511  
Fax: +55-11-3288-6940

- **Mexico**

- **Anritsu Company, S.A. de C.V.**

Bldv Miguel de Cervantes Saavedra #169 Piso 1, Col. Granada  
Mexico, Ciudad de Mexico, 11520, MEXICO  
Phone: +52-55-4169-7104

- **United Kingdom**

- **Anritsu EMEA Ltd.**

200 Capability Green, Luton, Bedfordshire, LU1 3LU, U.K.  
Phone: +44-1582-433200  
Fax: +44-1582-731303

- **France**

- **Anritsu S.A.**

12 avenue du Québec, Immeuble Goyave,  
91140 VILLEBON SUR YVETTE, France  
Phone: +33-1-60-92-15-50

- **Germany**

- **Anritsu GmbH**

Nemetschek Haus, Konrad-Zuse-Platz 1,  
81829 München, Germany  
Phone: +49-89-442308-0  
Fax: +49-89-442308-55

- **Italy**

- **Anritsu S.r.l.**

Spaces Eur Arte, Viale dell'Arte 25, 00144 Roma, Italy  
Phone: +39-6-509-9711

- **Sweden**

- **Anritsu AB**

Kistagången 20 B, 2 tr, 164 40 Kista, Sweden  
Phone: +46-8-534-707-00

- **Finland**

- **Anritsu AB**

Technopolis Aviapolis, Teknobulevardi 3-5 (D208.5),  
FI-01530 Vantaa, Finland  
Phone: +358-20-741-8100

- **Denmark**

- **Anritsu A/S**

c/o Regus Winghouse, Ørestads Boulevard 73, 4th floor,  
2300 Copenhagen S, Denmark  
Phone: +45-7211-2200

- **Spain**

- **Anritsu EMEA Ltd.**

- **Representation Office in Spain**

Paseo de la Castellana, 141. Planta 5, Edificio Cuzco IV  
28046, Madrid, Spain  
Phone: +34-91-572-6761

- **Austria**

- **Anritsu EMEA GmbH**

Am Belvedere 10, A-1100 Vienna, Austria  
Phone: +43-(0)1-717-28-710

- **United Arab Emirates**

- **Anritsu EMEA Ltd.**

- **Anritsu A/S**

Office No. 164, Building 17, Dubai Internet City  
P. O. Box – 501901, Dubai, United Arab Emirates  
Phone: +971-4-3758479

- **India**

- **Anritsu India Private Limited**

6th Floor, Indiqube ETA, No.38/4, Adjacent to EMC2,  
Doddanekundi, Outer Ring Road, Bengaluru – 560048, India  
Phone: +91-80-6728-1300  
Fax: +91-80-6728-1301

- **Singapore**

- **Anritsu Pte. Ltd.**

1 Jalan Kilang Timor, #07-04/06 Pacific Tech Centre  
Singapore 159303  
Phone: +65-6282-2400  
Fax: +65-6282-2533

- **Vietnam**

- **Anritsu Company Limited**

16th Floor, Peakview Tower, 36 Hoang Cau Street, O Cho Dua Ward,  
Dong Da District, Hanoi, Vietnam  
Phone: +84-24-3201-2730

- **P.R. China (Shanghai)**

- **Anritsu (China) Co., Ltd.**

Room 2701-2705, Tower A, New Caohejing International  
Business Center No. 391 Gui Ping Road Shanghai, 200233, P.R. China  
Phone: +86-21-6237-0898  
Fax: +86-21-6237-0899

- **P.R. China (Hong Kong)**

- **Anritsu Company Ltd.**

Unit 1006-7, 10/F., Greenfield Tower, Concordia Plaza,  
No. 1 Science Museum Road, Tsim Sha Tsui East,  
Kowloon, Hong Kong, P.R. China  
Phone: +852-2301-4980  
Fax: +852-2301-3545

- **Japan**

- **Anritsu Corporation**

8-5, Tamura-cho, Atsugi-shi, Kanagawa, 243-0016 Japan  
Phone: +81-46-296-6509  
Fax: +81-46-225-8352

- **Korea**

- **Anritsu Corporation, Ltd.**

8F, A TOWER, 20, Gwacheondaero 7-gil, Gwacheon-si,  
Gyeonggi-do, 13840, Republic of Korea  
Phone: +82-2-6259-7300  
Fax: +82-2-6259-7301

- **Australia**

- **Anritsu Pty. Ltd.**

Unit 20, 21-35 Ricketts Road, Mount Waverley, Victoria 3149, Australia  
Phone: +61-3-9558-8177  
Fax: +61-3-9558-8255

- **Taiwan**

- **Anritsu Company Inc.**

7F, No. 316, Sec. 1, NeiHu Rd., Taipei 114, Taiwan  
Phone: +886-2-8751-1816  
Fax: +886-2-8751-1817