



SmartStudio NR

Radio Communication Test Station
MT8000A



This presentation provides an overview of Anritsu's short and long-term development plans.

This presentation are based upon development times, market trends, and customer requirements; they may be subject to partial amendments as requirements change.

To ensure that our products match market demands, we always value input from our customers.

Contents

Market Trend & Anritsu 5G Test Solution

SmartStudio NR Introduction

Appendix - HW/SW total test by one platform

Appendix - SSNR

Appendix - MD8475B Introduction

Contents

Market Trend & Anritsu 5G Test Solution

SmartStudio NR Introduction

Appendix - HW/SW total test by one platform

Appendix - SSNR

Appendix - MD8475B Introduction

5G Network Architecture Deployment

Option	SA/NSA	Structures			Official Terminology
		Core Network	CP/UP	Add UP	
Option 1	SA	EPC(LTE)	LTE	-	E-UTRA
Option 2	SA	5G-CN(NR)	NR	-	
Option 3/3a/3x	NSA	EPC(LTE)	LTE	NR	EN-DC (E-UTRA-NR Dual Connectivity)
Option 4/4a	NSA	5G-CN(NR)	NR	LTE	
Option 5	SA	5G-CN(NR)	LTE	-	
Option 6	SA	EPC(LTE)	NR		
Option 7/7a	NSA	5G-CN(NR)	LTE	NR	
Option 8/8a	NSA	EPC(LTE)	NR	LTE	

SA
NSA

The voice application required for the handset has also will be changed from current VoLTE.

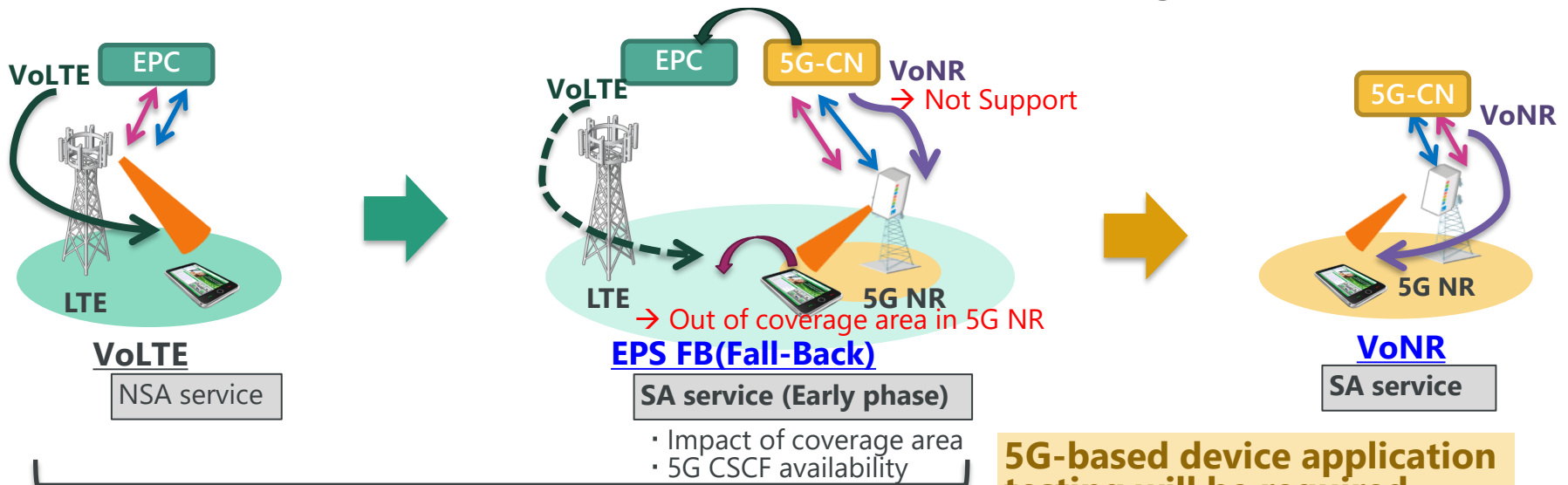

Mainstream voice services during the 5G introduction stage

Common platform for overall Mobile R&D/Mfg. Cycle

MX800070A SSNR



**Smart Device Integration
Application Test/SW Maintenance**

**ME7873NR
RF Conformance test system**



RF Conformance Test

**ME7834NR
5G NR Mobile Device Test Platform**



**Protocol Conformance Test
Carrier Acceptance Test**

MX800010A RF Meas.



**MT8000A
Radio Communication Test Station**



RF Performance Verification

MX800050A RTD

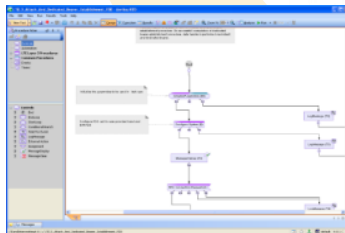

Chipset/Protocol Development

**MX800040A
NR mmW Production Test**



**MT8870A
Universal Wireless test set**



Volume Production



Comprehensive Set of Hardware & Options

Flexible modular architecture for various test need

MT8000A-001 Control Module

Control for each MT8000A module

MT8000A-012 Data Test Module

Simulate U-plane stack with built-in IP generator

MT8000A-011 Baseband Module

Simulate full-stack 5G NR gNB signaling.

MT8000A-020 RF Base Module

RF Base module for mmW RF TRx.

RF Sub Modules :Installed on RF Base Module

MT8000A-021 0.4GHz-6GHz RF Sub Module

RF module for Sub-6GHz RF TRx. (4Tx, 4Rx, 2SLOT).

MT8000A-031/032 Multi RF Module

RF module for Sub-6GHz RF TRx. (8Tx, 4Rx, 2SLOT).

MT8000A-033 Enhanced RF Module

8Tx/4Rx per slot, 0.4GHz to 7.125GHz, + converter IF

RF Converter for mmWave

MA80003A Multiband RF Converter

Supports FR2 frequency range external up converter

MT8000A Mainframe

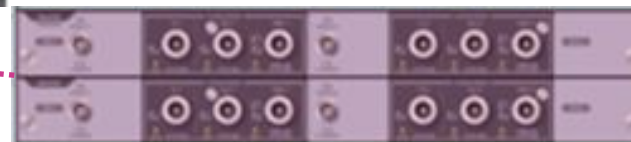

FR2 RF Converter

New RF module MT8000A-033

- Features
 - RF Ports: **4 sets of RF input/output connectors per slot** (N type Main In/Out and SMA type Aux Out)
 - Tx: **8 RF transmitters per slot** (totally 16 Tx in a box, 4x4 MIMO 4 bands available)
 - Rx: **4 RF receivers per slot** (totally 8 Rx in a box, for UL 2x2 MIMO and UL antenna switch)
 - Frequency range: **FR1 : 400 MHz to 7125 MHz, FR2: Depends on RF converter**
- Input/output (FR1, FR2 : Ports/slot)
 - FR1 : 4 Ports/slot (Main1/2/3/4 – RF In/Out, Aux1/2/3/4 – RF Out (exclusive with Main output))
 - FR2 : 2 Ports/slot (RF Converter1/2 – MA8000xA connection)
- Transmitter
 - FR1 Bandwidth : **OBW 800 MHz (IBW 1200 MHz)**
 - FR2 Bandwidth : **1000 MHz**
 - FR1 Upper freq: **4Tx are up to 7125 MHz, remaining 4Tx are up to 5000 MHz**
- Receiver
 - Receive waveform bandwidth Standard **800 MHz** / extended up to 1200 MHz
 - Signal analysis bandwidth Standard **800 MHz** / Max 1200 MHz

Output/Input for FR1 or FR2

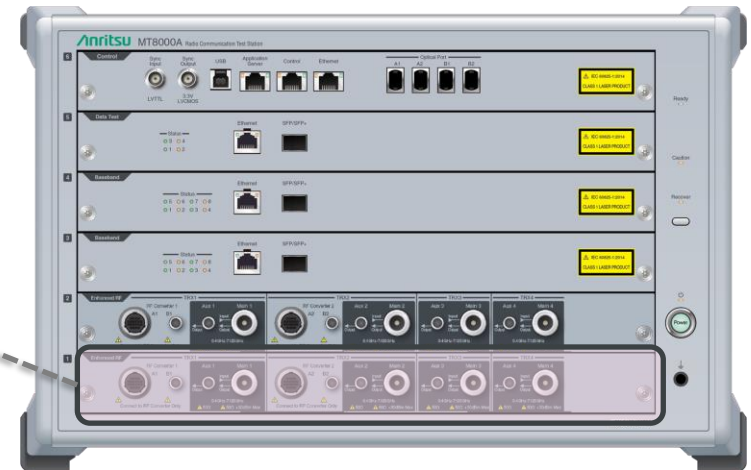
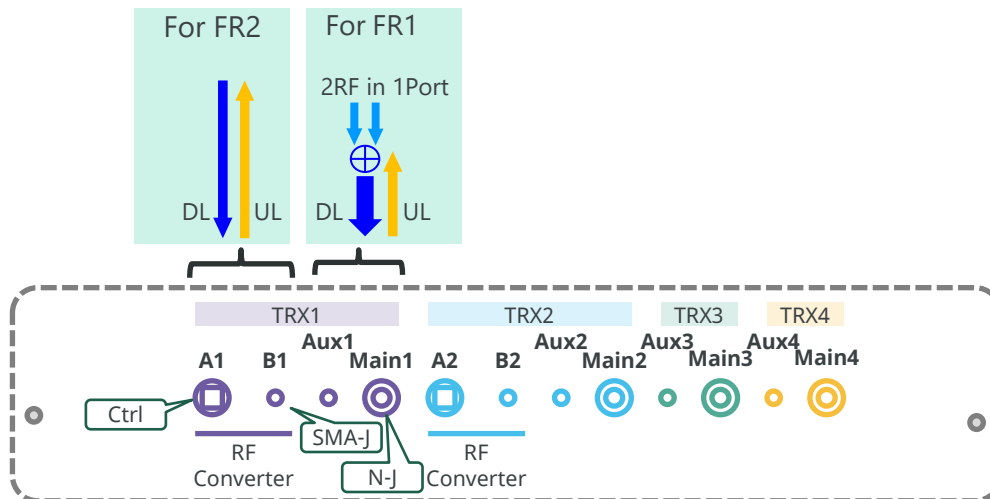

MT8000A

Radio Communication Test Station

5GNR ALL in ONE test platform.

Possible to install each application in one platform and just switch by system number

Platform GUI



Test Applications

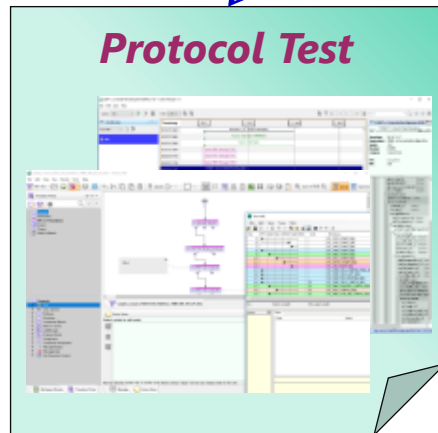

MX800050A
Rapid Test Designer Platform (RTD)



MX800010A
TRx Measurement.

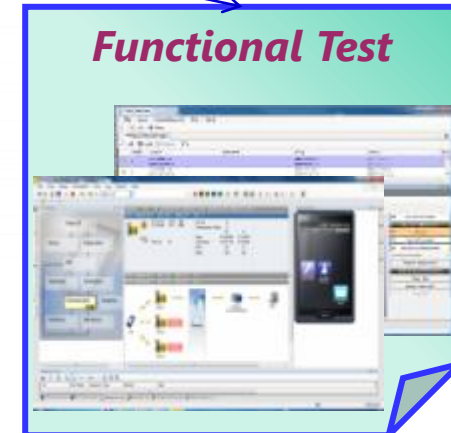

MX800070A
SmartStudio NR (SSNR)

Contents

Market Trend & Anritsu 5G Test Solution

SmartStudio NR Introduction

Appendix - HW/SW total test by one platform

Appendix - SSNR

Appendix - MD8475B Introduction

Easy Operation with State-machine GUI for 5G device function test

No.	Time Stamp	Sequence Type	Direction	Data
53	000:00:00	Parameter	NR1	Cell Parameter (Default Cell A_BTS1)
54	000:00:00	Parameter	NR2	Cell Parameter (Default Cell B_BTS2)
55	000:00:00	Parameter	LTE1	Cell Parameter (Default Cell A_BTS3)
56	000:00:00	Parameter	LTE2	Cell Parameter (Default Cell B_BTS4)
57	000:00:00	Parameter	LTE3	Cell Parameter (Default Cell C_BTS5)

SmartStudio NR (SSNR)

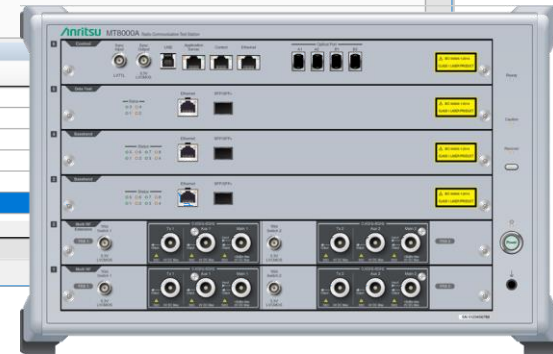

- Interactive 5G(NSA/SA) test environment **without any complex test scripts**
- Network parameter settings matching user test environment
- Included IMS server for SIP based application test
- Unique graphical SMS/PWS Centre applications for SMS/CMAS/ETWS service

Multiple GUI windows are provided to efficiently analyze test settings and results according to the test application.

Throughput Monitor/Measure Window/SMS Centre/IMS Services

Simulation/Cell Parameter

Test Case Editor

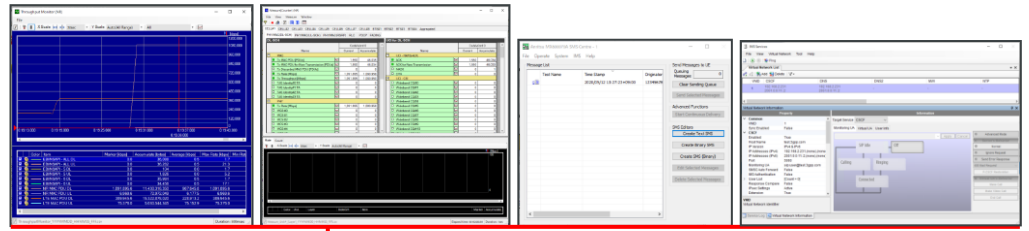
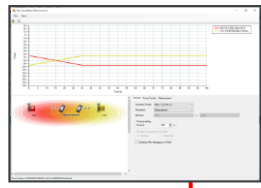
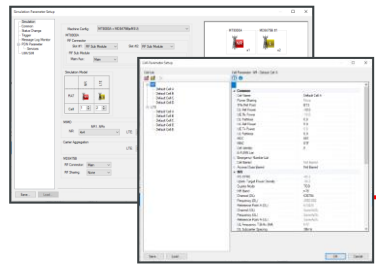

Simulation Start/Stop

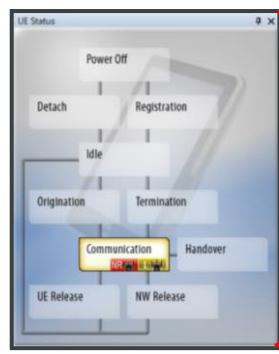

UE Status

Cell Parameter.

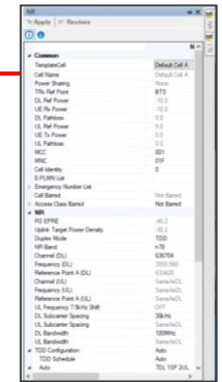

PDN Information/Sequence Log/Message Log/Trigger Information

Easy setup of 5G network environment

- ✓ Easy to use and easy to understand GUI for system setting.
- ✓ Simple setting for multi-cell test by GUI based Test Case Editor
- ✓ Supports simple TDD setting to simulate each network.

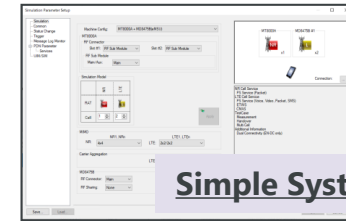

Simple System Setting

Test Case Editor

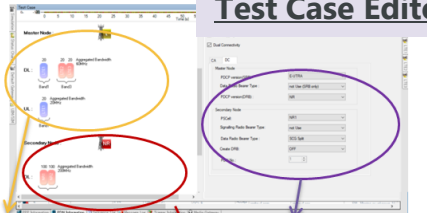

LTE Band combination

Network parameter setting (Ex: Option 3x)

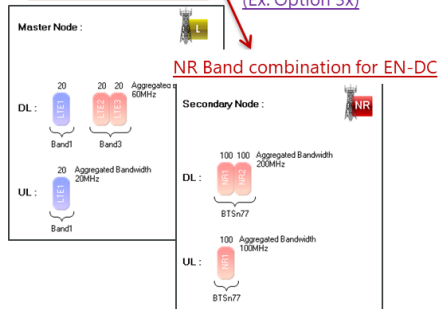

TDD Configuration Setup [Manual]

Slot	0	1	2	3	4	5	6	7	8	9	10	11	12	13	14
DL/UL Allocation	D	D	D	D	S	D	G	D	U	U	D	D	D	D	S
Number of DL Symbols	14	14	14	14	14	14	14	0	14	0	14	14	14	14	14
Number of UL Symbols	0	0	0	0	0	0	0	0	14	14	0	0	0	0	0
PDSCH															
K1	+8	+7	+6	+5	+5	+4	-	+2	-	-	+8	+7	+6	+5	+5
Symbols	11	11	11	11	11	11	-	11	-	-	11	11	11	11	11
PUSCH															
K2	-	-	-	+5	-	-	-	+2	-	-	-	-	-	-	+5
Symbols	-	-	-	14	-	-	-	14	-	-	-	-	-	-	14

NR TDD Configuration Setup

Supports effective analysis by real-time logging

- ✓ L3 Message log
- ✓ L3 Message detail window
- ✓ UE Capability information

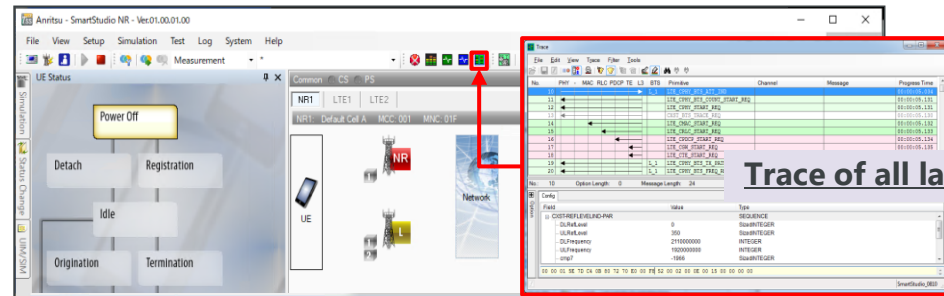

Trace of all layers

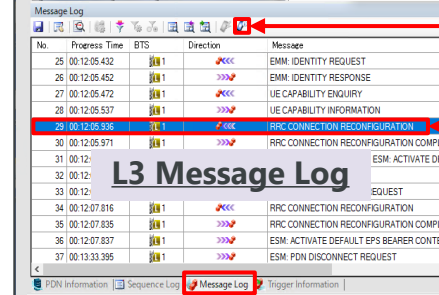

L3 Message Log

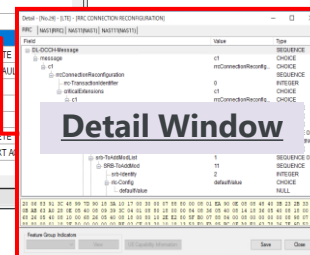

Detail Window

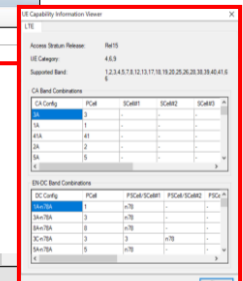

UE Capability information

Contribute to 5G device UX improvement with SSNR

T-put performance

Measurement counter

- ✓ ACK, NACK, DTX
- ✓ CQI

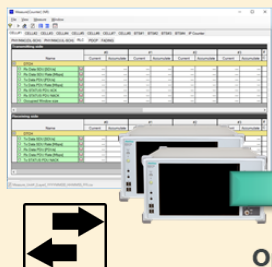

T-put monitor

- ✓ MAC level (LTE, NR)
- ✓ IP level

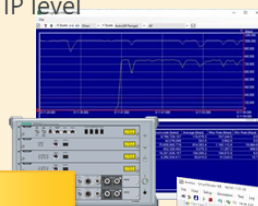

Option3x EN-DC



IMS Functions

IMS Services

- ✓ CSCF/DNS
- ✓ NDP/XCAP
- ✓ Suppl. Service
- ✓ Conference
- ✓ RTP Frame control

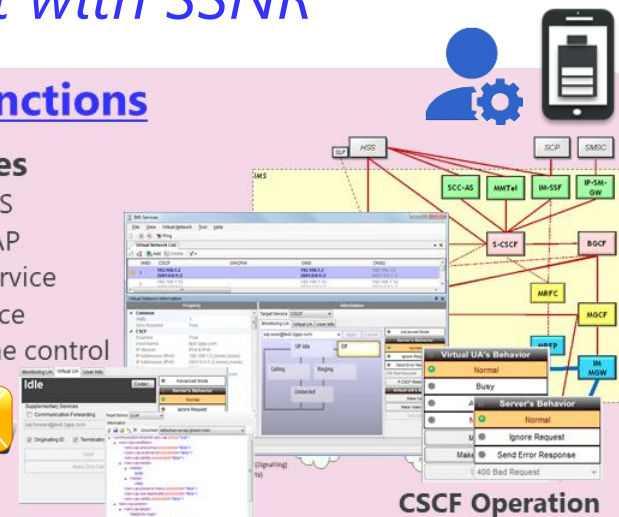

Supplementary Service

CSCF Operation

Server Applications

Internet connection

- ✓ OTT Apps
- ✓ Firmware download



SmartStudio NR (SSNR)

Messaging service

SMS Centre

- ✓ SMS over SGs
- ✓ SMS over IMS

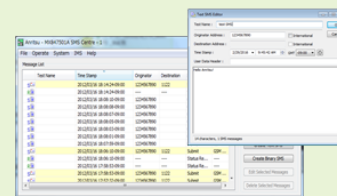

PWS Centre

- ✓ ETWS
- ✓ CMAS

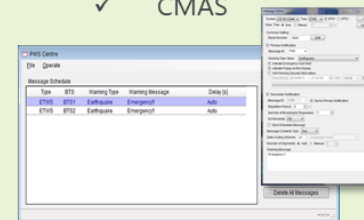

HW performance check for Max T-put

- ✓ Easy to check the status of each cell and IP layer by monitor tools
 - ⇒ Software tuning for maximum throughput
- ✓ Ensured the stability and reproducibility IP connection
 - ⇒ Device Thermal Test in high throughput condition

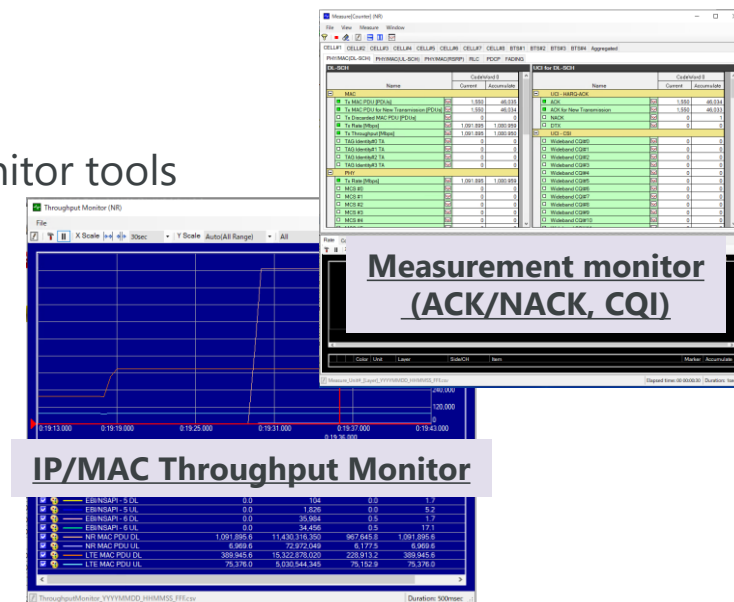

User Experience Evaluation using Real Application

- ✓ Automatic operation according to the connection status by the state machine GUI
 - UE Status change, Connected DRX(CDRX), Dynamic scheduling, Auto EN-DC Connection
 - ⇒ Device Battery Life Test using OTT application

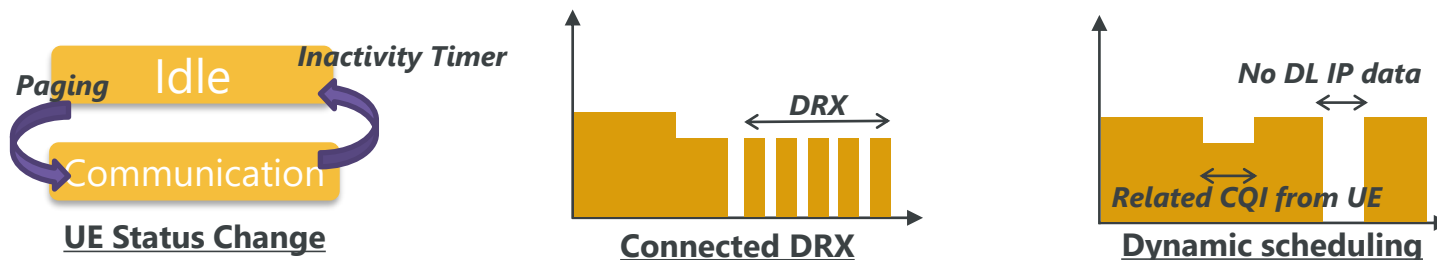

SSNR provides a more efficient test environment for EN-DC mobility testing without the need to create complicated scenarios.

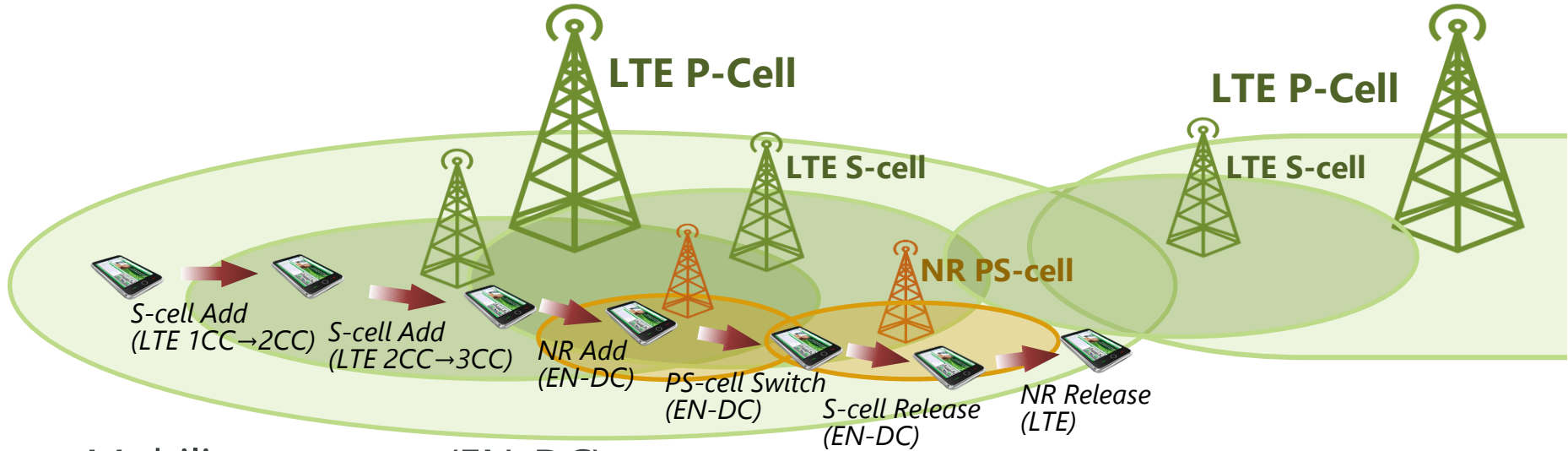

■ Mobility test case (EN-DC)

Test case	SmartStudio	SSNR	Remarks
LTE S-cell Add	Supported	Supported	
LTE S-cell Release	Supported	Supported	
LTE S-cell Switch	Supported	Supported	Up to 2CC & 2x2MIMO configuration
NR Add (EN-DC connection)	-	Supported	
NR Release (LTE connection)	-	Supported	
NR Switch (PS-cell Switch)	-	Supported	
LTE P-cell HO	Supported	Supported	Up to 2CC & 2x2MIMO configuration

When the SA service starts, the mobility function with LTE is very important to secure the coverage area of UE.

→ SSNR is preparing to conduct mobility tests effectively.

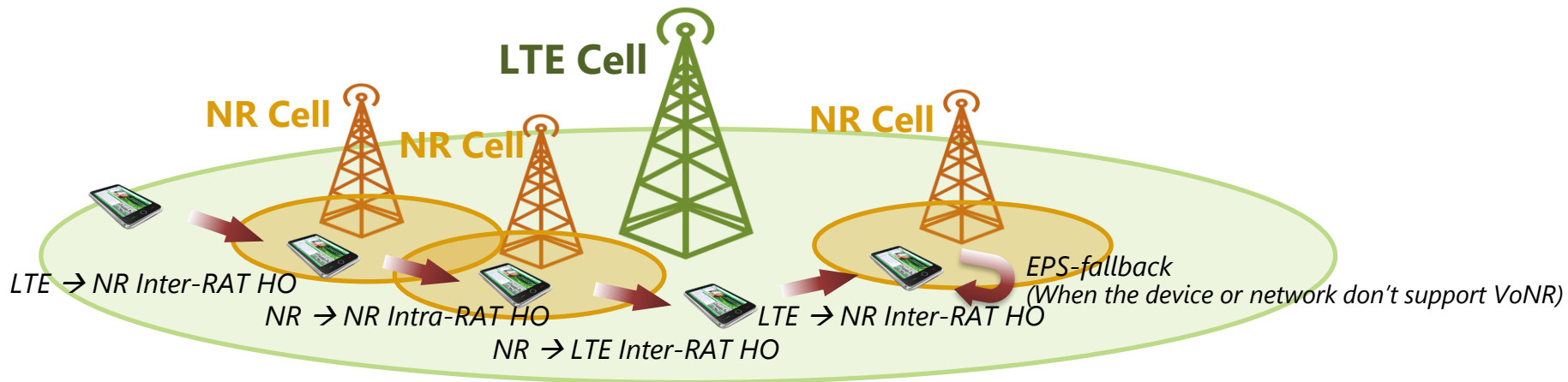

■ Mobility test case (SA(NR) –LTE)

Test case	SSNR (MT8000A Single box)	SSNR (MT8000A+MD8475B)	Remarks
EPS-fallback	Supported	Supported	
NR -> NR Intra-RAT Handover	Supported	Supported	NR SIB2, SIB3 and SIB4 are supported.
NR -> LTE Inter-RAT Handover	Supported	Supported	NR SIB2, SIB3 and SIB4 are supported.
LTE -> NR Inter-RAT Handover	Supported	Supported	LTE SIB24 is supported.

SSNR supports LTE/NSA abnormal simulation by easy setup
 → Possible to evaluate device that are more like a live network environment.

Supported Message(UE Trigger)

LTE	Message Name
NAS(ESM)	PDN Connectivity Request(Attach Request)
	PDN Connectivity Request(UL Information Transfer)
	PDN Disconnect Request
	Bearer Resource Allocation Request
	Bearer Resource Modification Request
	Deactivate EPS Bearer Context Request
NAS(EMM)	Service Request
	Attach Request
	Tracking Area Update Request
	Extended Service Request
	Authentication Failure
	Detach Request(NW to UE)
RRC (E-UTRAN)	RRC Connection Reestablishment Request
	RRC Connection Request

Extended support for Octet 5 (RestrictDCNR, S1-UData...)

Supported Message (NW Trigger)

LTE	Message Name
NAS(ESM)	Notification
NAS(EMM)	Detach Request(NW to UE)
	GUTI reallocation command
	Identity Request
	EMM Information
	RRC Connection Release
RRC (E-UTRAN)	UE Capability Enquiry
	Counter Check
	UE Information Request
	Logged Measurement Configuration
MAC	Activation MAC Control Element
	Deactivation MAC Control Element
	Activation/Deactivation MAC Control Element
PHY	Aperiodic CSI Request

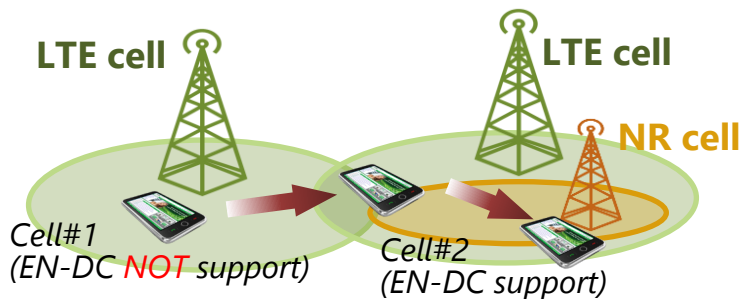

- Accept
- **Reject**
- Ignore
- User Data

Reject Cause

UE Trigger for SA Abnormal Simulation

Plan to support setting 5G protocol-based Reject cause without the need to modify the scenario.

Possible to easily simulate various 5GC network situations.

Supported Message(UE Trigger)

NR(5G Core)	Message Name
NAS (5GSM)	PDU Session Establishment Request
NAS (5GMM)	Registration Request
	Service Request
RRC (E-UTRAN)	RRC Setup Request

5GSM Cause value (octet 2)								
8	7	6	5	4	3	2	1	
0	0	0	0	1	0	0	0	Operator determined barring
0	0	0	1	1	0	1	0	Insufficient resources
0	0	0	1	1	0	1	1	Missing or unknown DNN
0	0	0	1	1	1	0	0	Unknown PDU session type
0	0	0	1	1	1	0	1	User authentication or authorization failed
0	0	0	1	1	1	1	1	Request rejected, unspecified
0	0	0	1	1	1	1	0	Service option not supported
0	0	0	1	1	1	1	1	Requested service option not subscribed
0	0	0	1	1	1	1	1	PTI already in use
0	0	0	1	1	1	1	0	Regular deactivation
0	0	0	1	1	1	1	0	Network failure
0	0	0	1	1	1	1	1	Reactivation requested
0	0	0	1	1	1	1	1	Semantic error in the TFT operation
0	0	0	1	1	1	1	0	Syntactical error in the TFT operation
0	0	0	1	1	1	1	1	Invalid PDU session identity
0	0	0	1	1	1	1	0	Semantic errors in packet filter(s)
0	0	0	1	1	1	1	1	Syntactical error in packet filter(s)
0	0	0	1	1	1	1	0	Out of LADN service area
0	0	0	1	1	1	1	1	PTI mismatch
0	0	0	1	1	1	1	0	PDU session type IPv4 only allowed
0	0	0	1	1	1	1	1	PDU session type IPv6 only allowed
0	0	0	1	1	1	1	0	PDU session does not exist
0	0	0	1	1	1	1	1	PDU session type IPv4v6 only allowed
0	0	0	1	1	1	1	0	PDU session type Unstructured only allowed
0	0	0	1	1	1	1	1	Unsupported 5QI value
0	0	0	1	1	1	1	0	PDU session type Ethernet only allowed
0	0	0	1	1	1	1	1	Insufficient resources for specific slice and DNN
0	0	0	1	1	1	1	0	Not supported SSC mode
0	0	0	1	1	1	1	1	Insufficient resources for specific slice
0	0	0	1	1	1	1	0	Missing or unknown DNN in a slice
0	0	0	1	1	1	1	1	Invalid PTI value
0	0	0	1	1	1	1	0	Maximum data rate per UE for user-plane integrity protection is too low
0	0	0	1	1	1	1	1	Semantic error in the QoS operation
0	0	0	1	1	1	1	0	Syntactical error in the QoS operation
0	0	0	1	1	1	1	1	Invalid mapped EPS bearer identity
0	0	0	1	1	1	1	0	Semantically incorrect message
0	0	0	1	1	1	1	1	Invalid mandatory information
0	0	0	1	1	1	1	0	Message type non-existent or not implemented
0	0	0	1	1	1	1	1	Message type not compatible with the protocol state
0	0	0	1	1	1	1	0	Information element non-existent or not implemented
0	0	0	1	1	1	1	1	Conditional IE error
0	0	0	1	1	1	1	0	Message not compatible with the protocol state
0	0	0	1	1	1	1	1	Protocol error, unspecified

5GMM Cause value (octet 2)								
8	7	6	5	4	3	2	1	
0	0	0	0	0	0	1	1	Illegal UE
0	0	0	0	0	1	0	1	PEI not accepted
0	0	0	0	0	1	1	0	Illegal ME
0	0	0	0	0	1	1	1	SGS services not allowed
0	0	0	0	1	0	0	1	UE identity cannot be derived by the network
0	0	0	0	1	0	1	0	Implicitly de-registered
0	0	0	0	1	0	1	1	PLMN not allowed
0	0	0	0	1	1	0	0	Tracking area not allowed
0	0	0	0	1	1	0	1	Roaming not allowed in this tracking area
0	0	0	0	1	1	1	1	No suitable cells in tracking area
0	0	0	1	0	0	0	0	MAC failure
0	0	0	1	0	1	0	1	Synch failure
0	0	0	1	0	1	1	0	Congestion
0	0	0	1	0	1	1	1	UE security capabilities mismatch
0	0	0	1	1	0	0	0	Security mode rejected, unspecified
0	0	0	1	1	0	1	0	Non-5G authentication unacceptable
0	0	0	1	1	0	1	1	N1 mode not allowed
0	0	0	1	1	1	0	0	Restricted service area
0	0	0	1	1	1	1	1	Redirection to EPC required
0	0	0	1	1	1	1	0	LADN not available
0	0	0	1	1	1	1	1	No network slices available
0	0	0	1	1	1	1	0	Maximum number of PDU sessions reached
0	0	0	1	1	1	1	1	Insufficient resources for specific slice and DNN
0	0	0	1	1	1	1	0	Insufficient resources for specific slice
0	0	0	1	1	1	1	1	ngKSI already in use
0	0	0	1	1	1	1	0	Non-3GPP access to 5GCN not allowed
0	0	0	1	1	1	1	1	Serving network not authorized
0	0	0	1	1	1	1	0	Temporarily not authorized for this SNPN
0	0	0	1	1	1	1	1	Permanently not authorized for this SNPN
0	0	0	1	1	1	1	0	Not authorized for this CAG or authorized for CAG cells only
0	0	0	1	1	1	1	1	Wireline access area not allowed
0	0	0	1	1	1	1	0	Payload was not forwarded
0	0	0	1	1	1	1	1	DNN not supported or not subscribed in the slice
0	0	0	1	1	1	1	0	Insufficient user-plane resources for the PDU session
0	0	0	1	1	1	1	1	Semantically incorrect message
0	0	0	1	1	1	1	0	Invalid mandatory information
0	0	0	1	1	1	1	1	Message type non-existent or not implemented
0	0	0	1	1	1	1	0	Message type not compatible with the protocol state
0	0	0	1	1	1	1	1	Information element non-existent or not implemented
0	0	0	1	1	1	1	0	Conditional IE error
0	0	0	1	1	1	1	1	Message not compatible with the protocol state
0	0	0	1	1	1	1	1	Protocol error, unspecified

UE/NW Trigger for EN-DC UE Capability Info

The information on “band combination” is huge due to the combination with EN-DC in addition to the higher-order CA of LTE. In some cases, global devices send more than the 3GPP specifications. Even if the size does not exceed the specifications, the load on the network side is an issue for large size data, so network are considering to reduce the data size of one message.

→ In order to simulate the above situation on the device, the “UE capability enquiry” function is extended with the Trigger function of SSNR.

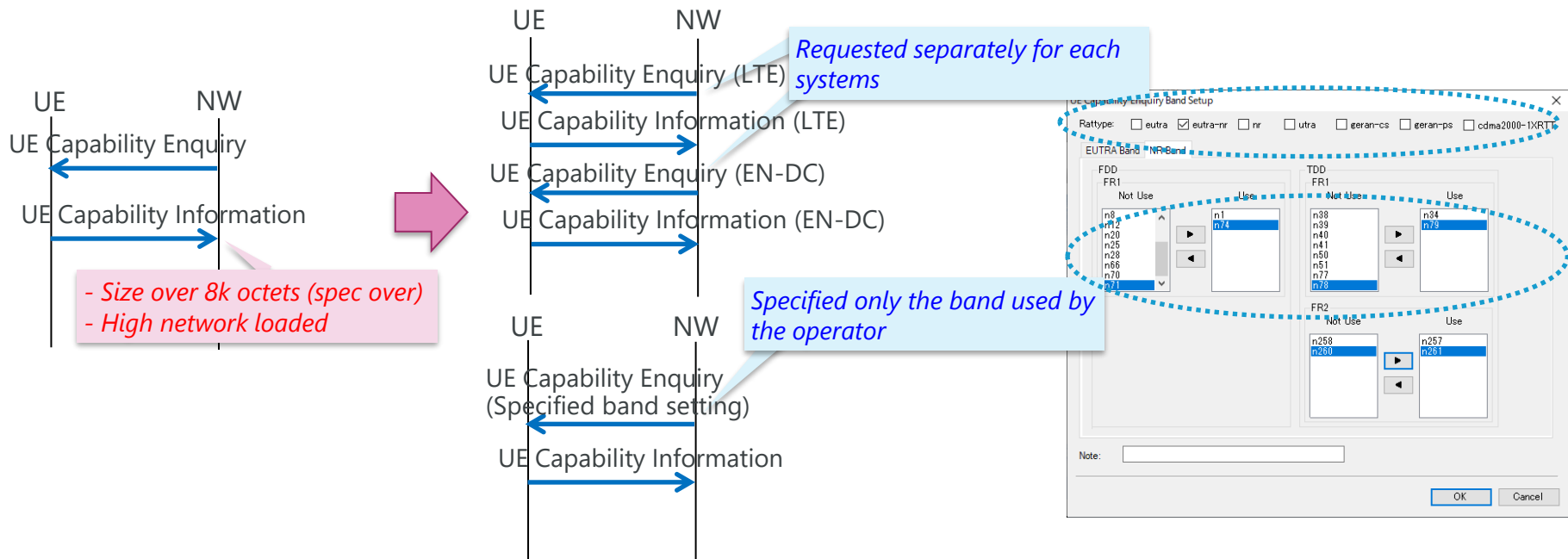

Key Unique Points

Ease-of-use

- SSNR GUI for easy IMS test configuration and setting
- No complex test scripts

Comprehensive IMS Tests

- Supports wide test range, including irregular and supplementary services tests
- Add-in Service PSAP supports emergency test and loopback voice data test functions

Analysis and Debug

- Simultaneous Wireshark and signalling protocol logging

Supported

- ✓ VoLTE (Option1, Option3x)
- ✓ EPS-FB(Option2 (Early-phase))
- ✓ **VoNR (Option2)**

IMS Services

IMS Supplementary Service

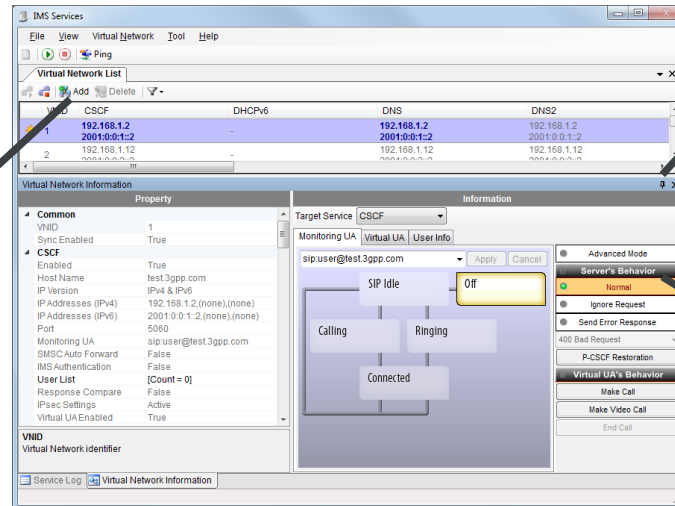
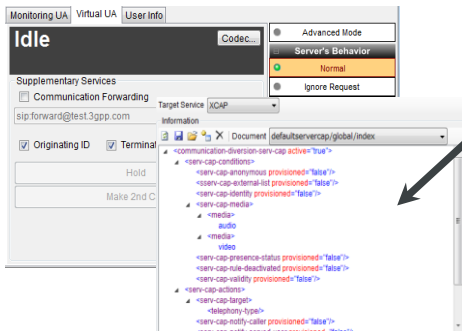

Simulate Abnormal Condition

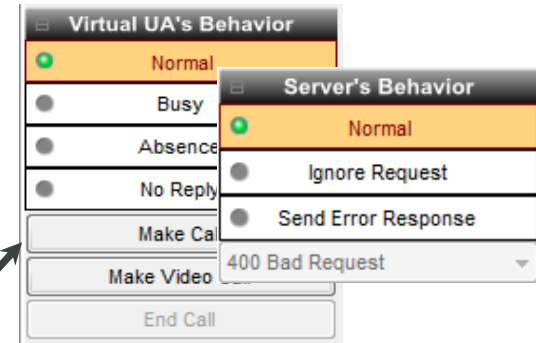

RTP Frame Control

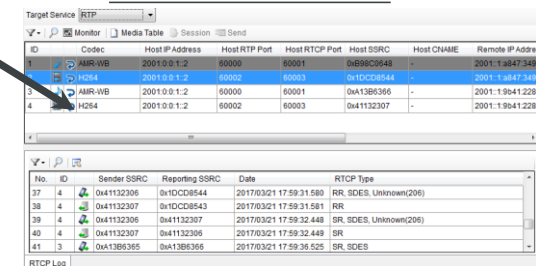

Propose two type IMS test solutions according to the customers situation.

Server mode



- ✓ Interactive test environment **without complicated test scripts**
- ✓ Possible to test for IMS function (VoLTE, SMS) without requiring deep knowledge of protocol

- ✓ Abnormal test for user specific doesn't support (Some abnormal tests are supported by Extended CSCF option.)
- ✓ Doesn't support operator-specific information. (Can't support ...)

Script mode

Step	Direction	Server	Message	Note
1	---	---	<Remarks>	Script : SMS_OVER_IMS_MO_AUTH
2	---	---	<Remarks>	Power on UE
3	→	CSCF1	REGISTER * SIP/2.0	1st REGISTER
4	←	CSCF1	SIP/2.0 401 Unauthorized	Unauthorized
5	→	CSCF1	REGISTER * SIP/2.0	2nd REGISTER
6	←	CSCF1	SIP/2.0 200 OK	REGISTER
7	→	CSCF1	SUBSCRIBE * SIP/2.0	SUBSCRIBE
8	←	CSCF1	SIP/2.0 200 OK	SUBSCRIBE
9	←	CSCF1	NOTIFY * SIP/2.0	NOTIFY

- ✓ It is necessary to create a test case by the user
 - Deep knowledge of IMS protocol required
 - Providing technical support service separately
 - **Conversion of Wireshark logs for easier test case creation**
- ✓ Scripts can be created using a ladder sequence, **supporting high flexibility and scalability.**
 - Possible to check user-specific abnormal tests and protocol check at any message level.
 - Call processing of LTE is by using the SmartStudio, the user can focus on function of IMS development and evaluation.
 - **Flexible support for evolving 5G core specification such as VoNR**

Support to build IMS test environment from Wireshark logs
 → Easy to reproduce the behavior in a live network

Key Features

- Fully automated IMS script file (.tef file) creation tools
- Supports SIP protocol and XCAP protocol
- Converted from Wireshark Log captured in live network operation
- An encrypted message can be converted with key value set
- Automates SSNR control (LTE/NR) part during converting process
- Converted script can be edited in message level using the Add-in Server window

Wireshark log

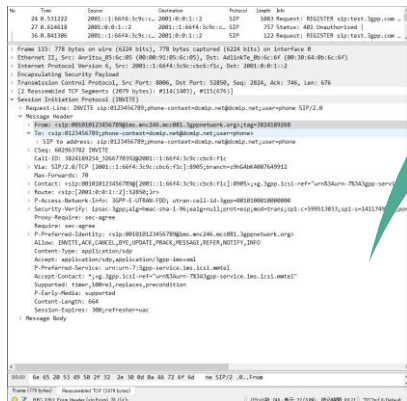

Import

IMS Script

Step	Direction	Server	Message	Note
1	---	---	<Remark>	Script: VOICE_MO_AUTH
2	---	---	<Remark>	Power on UE
3	→	CSCF1	REGISTER * SIP/2.0	1st REGISTER
4	←	CSCF1	SIP/2.0 401 Unauthorized	Unauthorized
5	→	CSCF1	REGISTER * SIP/2.0	2nd REGISTER
6	←	CSCF1	SIP/2.0 200 OK	REGISTER
7	→	CSCF1	SUBSCRIBE * SIP/2.0	SUBSCRIBE
8	←	CSCF1	SIP/2.0 200 OK	SUBSCRIBE
9	←	CSCF1	NOTIFY sip:*@%&SIP/2.0	
10	→	CSCF1	SIP/2.0 200 OK	NOTIFY
11	---	---	<Remark>	OutGoing call: 1111
12	→	CSCF1	INVITE * SIP/2.0	
13	←	CSCF1	SIP/2.0 100 Trying	
14	---	---	<SmartStudio> SET_TERMINATION	Terminate audio bearer
15	←	CSCF1	SIP/2.0 183 Session Progress	
16	→	CSCF1	PRACK * SIP/2.0	
17	←	CSCF1	SIP/2.0 200 OK	PRACK
18	→	CSCF1	UPDATE * SIP/2.0	
19	---	---	<SmartStudio> SET_TERMINATION	Terminate audio bearer
20	←	CSCF1	SIP/2.0 200 OK	UPDATE
21	←	CSCF1	SIP/2.0 180 Ringing	
22	→	CSCF1	PRACK * SIP/2.0	
23	←	CSCF1	SIP/2.0 200 OK	PRACK
24	←	CSCF1	SIP/2.0 200 OK	INVITE
25	→	CSCF1	ACK * SIP/2.0	
26	---	---	<Remark>	
27	→	CSCF1	BYE * SIP/2.0	
28	---	---	<SmartStudio> SET_RELEASE_FROM_IMS	Release audio bearer
29	←	CSCF1	SIP/2.0 200 OK	BYE

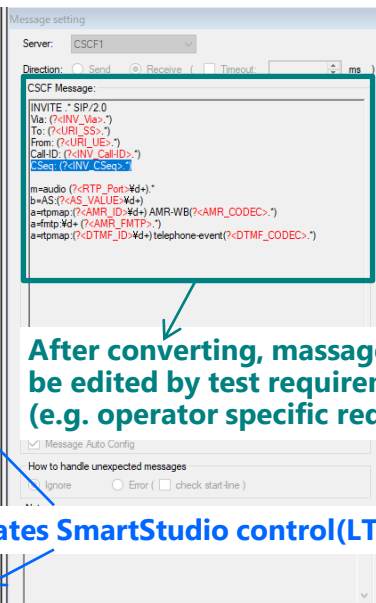

After converting, message header can be edited by test requirements (e.g. operator specific requirements)

Automates SmartStudio control(LTE/NR) part

SSNR prepare the unique GUI to simplify messaging test.

SMS Centre

- ✓ Text Message
- ✓ Binary Message

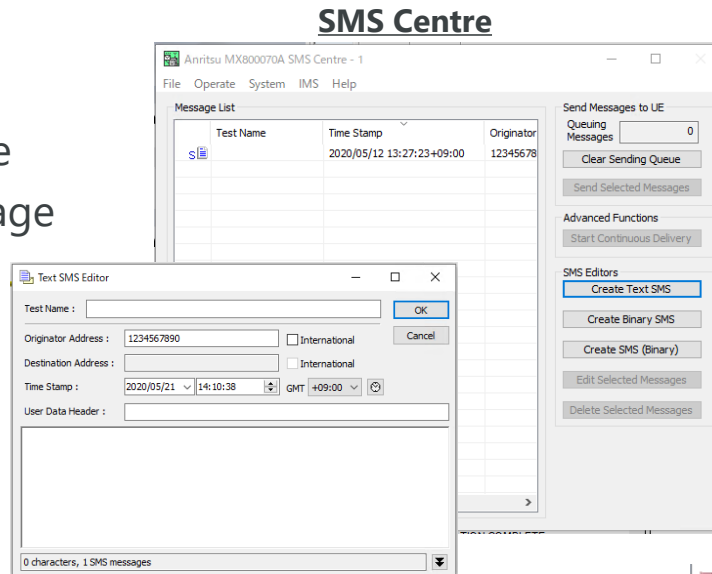

Supported condition

- ✓ Option 1 (LTE)
- ✓ Option 3x (EN-DC)
- ✓ Option 2 (SA) (Support in Oct. 2020)

PWS/CB Centre

- ✓ ETWS Message
- ✓ CMAS Message

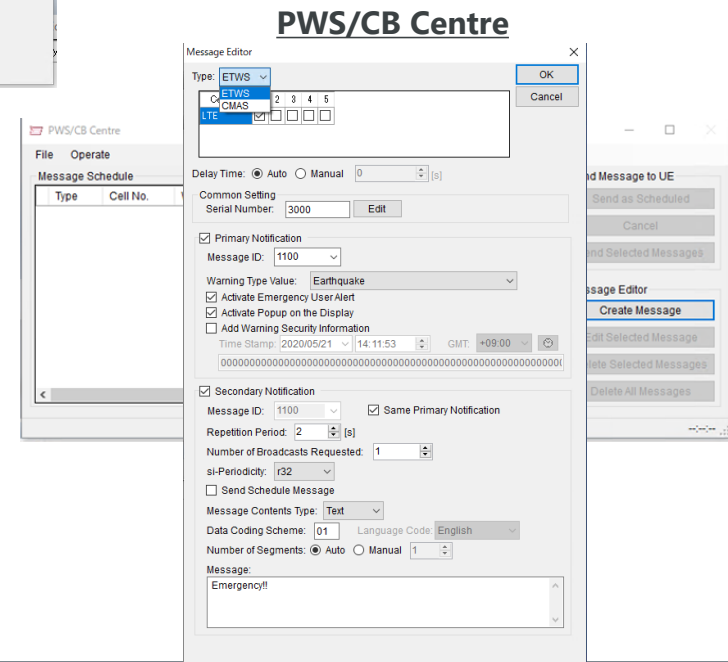

New Products - NRDC & UL 5CA

- MX800070A-014 NR FR1+FR2 Inter-working Option
- MX800070A-063 NR UL 5CA Option

NEW

- **Background:**

- Based on the full-scale launch of NR SA service, ensure area coverage with FR1 and increase speed/capacity with NRDC that utilizes FR2

- **Functional Scope:**

- Supports NRDC bearer extension with MT8000A-033 installed
 - DL: FR1 1CC 4x4MIMO + FR2 4CCs 2x2MIMO
 - UL: FR1 1CC SISO + FR2 4CCs SISO
- Expandable up to FR1/FR2 UL 2x2MIMO with 2 MT8000A (including 063Opt)
- Provides flexible bearer expansion with GUI for configuration changes such as Band Combination/MIMO/CA

- **Customer Value:**

- Realizes dynamic state control of test device assuming actual operation including SCG Add/Release at NRDC
- Combined DC/CA bearer expansion to create a high throughput environment. Possible to apply to device thermal test and battery consumption test.

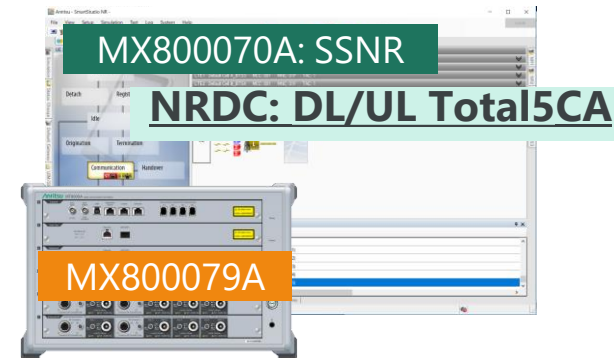

SSNR T-put test configuration

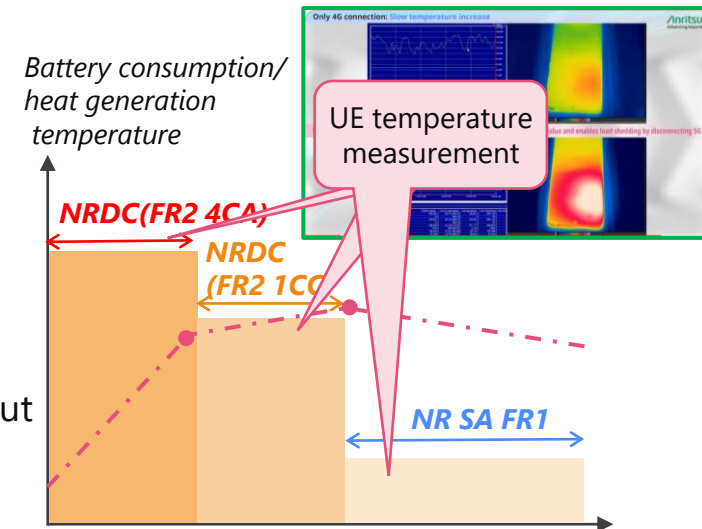

Changes in battery consumption/device heat generation temperature during NRDC

New Products - Neighbour Cell List

■ MX800070A-090 NR Neighbour Cell List

NEW

• Background:

- In order to optimize the cell search function of the device, which is difficult to do in the field, we will build a roaming test environment in the laboratory that conforms to the network of each country's operator.

• Functional scope:

- Optional notification information including neighbour cell information for cell search and roaming
- Transmission of up to 16 neighbour cell info for each NR/LTE
- Parameter modification via Remote API/GPIB commands

• Customer Value:

- In NR SA service, it is possible to flexibly simulate difficult cell search tests and roaming tests in the field by setting parameters related to selection/reselection to neighbour cell such as PLMN/Band/Power.

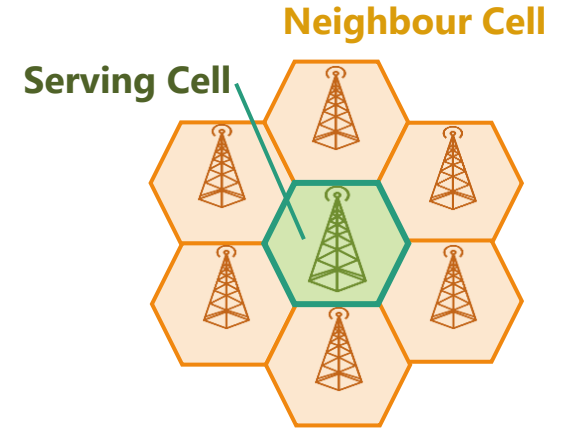

Cell arrangement image

Neighbour Cell Parameters	NR	LTE
Enable/Disable	✓	✓
MCC	✓	✓
MNC	✓	✓
Cell Identity	✓	✓
TAC	✓	✓
Channel(DL)	✓	✓
DL Bandwidth	✓	✓
Physical Cell ID	✓	✓
P-Max	✓	✓
RANAC	✓	
Duplex Mode	✓	
NR Band	✓	
DL Subcarrier Spacing	✓	
SSB Subcarrier Spacing	✓	
Carrier Frequency Mode	✓	
GSCN	✓	
Channel (SSB)	✓	
Q-RxLevMin		✓
Q-QualMin		✓
Cell Reselection Priority		✓

NR	LTE	Neighbour Cell	MCC	MNC	Cell Identity	TAC	RANAC	Duplex Mode	NR Band	Channel (DL)
Current		Default Cell A	001	01F	0	1	1	TDD	n77	650000
Neighbour 1		Default Cell A	001	01F	0	1	1	TDD	n77	650000
Neighbour 2		Default Cell B	001	01F	1	1	1	TDD	n77	650000
Neighbour 3		Disable	001	01F	0	1	1	TDD	n77	650000
Neighbour 4		Disable	001	01F	0	1	1	TDD	n77	650000
Neighbour 5		Disable	001	01F	0	1	1	TDD	n77	650000
Neighbour 6		Disable	001	01F	0	1	1	TDD	n77	650000
Neighbour 7		Disable	001	01F	0	1	1	TDD	n77	650000
Neighbour 8		Disable	001	01F	0	1	1	TDD	n77	650000
Neighbour 9		Disable	001	01F	0	1	1	TDD	n77	650000
Neighbour 10		Disable	001	01F	0	1	1	TDD	n77	650000

SSNR GUI image

Neighbour cell info list (NR/LTE)

SSNR supports the flexible configuration of S-NSSAI (SST/SD).
 → User can simulate various network situations.

TS24.501 9.11.2.8 S-NSSAI

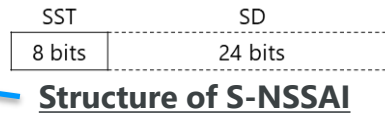
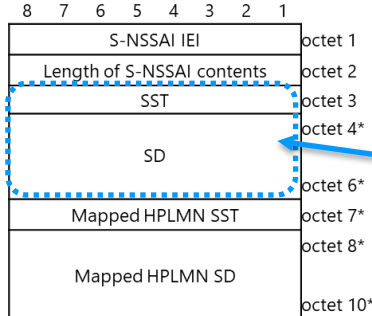

Slice/Service Type(SST)

Slice/Service type	SST value
eMBB	1
URLLC	2
MIoT	3
V2X	4
Operator-specified	128-255

Slice Differentiator (SD)

Unique value by Operator
 (FFFFFF : no SD value associated with the SST)

- DN : Data Network
- UPF : User Plane Function
- SMF : Session Management Function
- NSSF : Network Slice Selection Function
- UDM : Unified Data Management
- AMF : Access and Mobility Management Function
- CU-CP : Centralized Unit - Control Plane
- CU-UP : Centralized Unit - User Plane

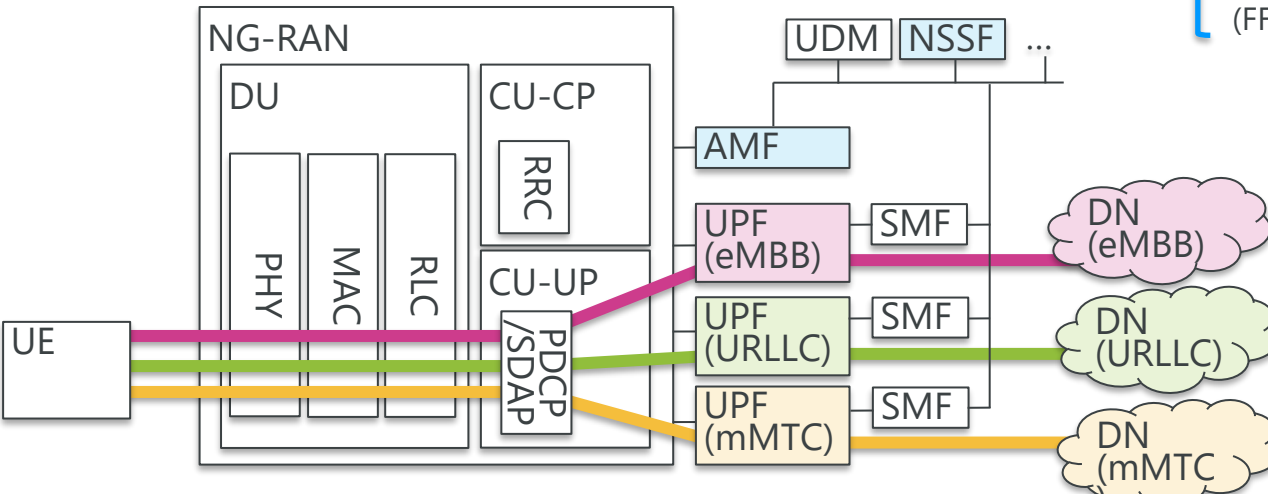

Only one setting is supported in the "allowed NSSAI list".
 → Support to set multiple S-NSSAI is currently under consideration.

5G **Audio Quality** evaluation is available with HEAD acoustics solution and SSNR.

Audio Quality test is categorized by MOS testing such as POLQA and Acoustics test such as 3GPP TS26.131/132. HEAD acoustics provides both test environment with strong suites.

5G voice communication (**VoNR**) has been already supported by SSNR.

By using SmartStudio/SSNR, customer can easily build Audio Quality evaluation environment for commercial device that suits each market.



Video Quality Test Solution with Umetrix

The combination of Umetrix and SSNR supports efficient video quality checks of mobile device that simulate various mobile communication environments.

→ Devices can be evaluated and optimized efficiently by establishing reproducibility, which is difficult to achieve with live networks.

■ Test Application

- Video Streaming Service/Application
- Video Chat/Conference Service/Application
- Web Live Video Casting Service/Application

■ Possible Situations

- Normal Connection (Stable connection)
- Cell Edge Area (Mobility environment)
- Weak Field Area (poor communication quality)

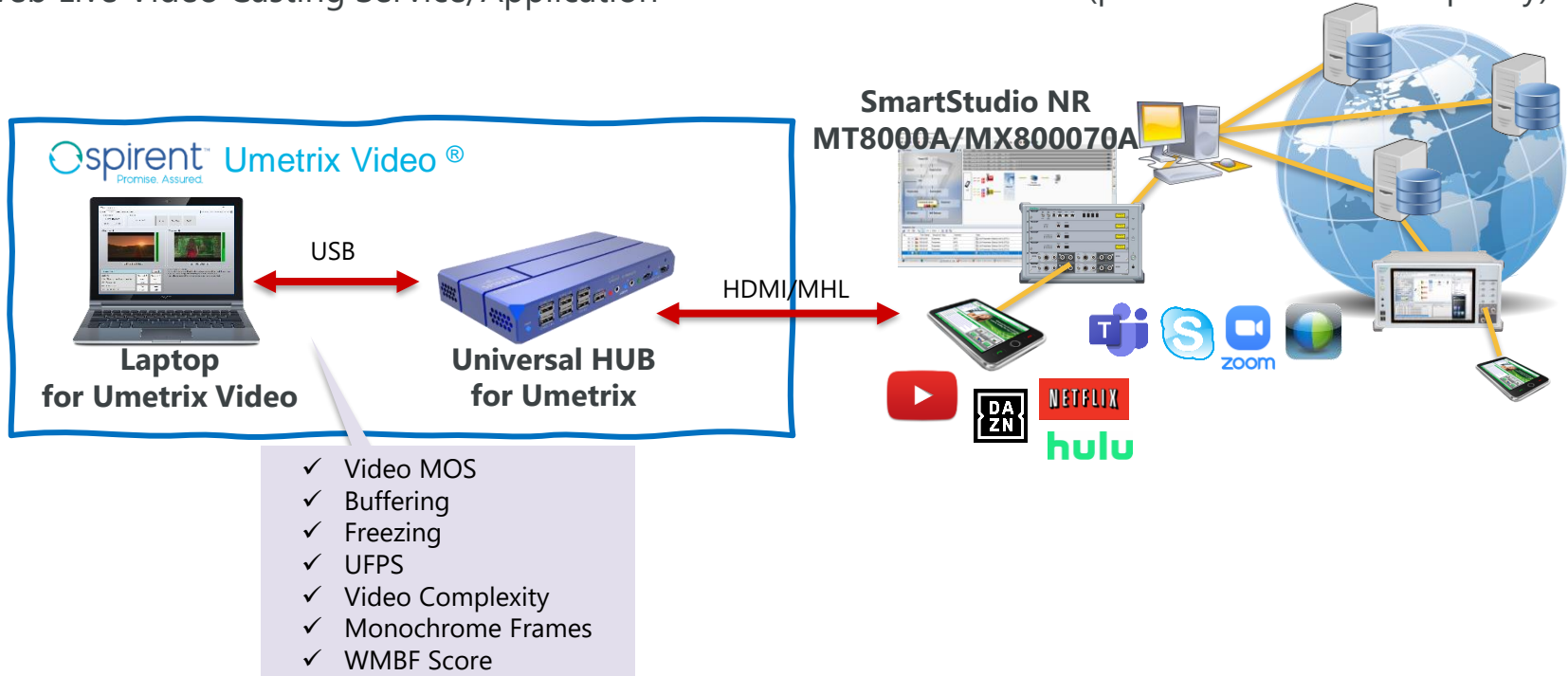

In DUT development, continuous testing by automated environment is effective for confirming existing functions and degradation testing associated with SW updates.

SSNR offers a variety of external control interfaces depending on the customer situation.

- GPIB
- Windows API
- SSM*

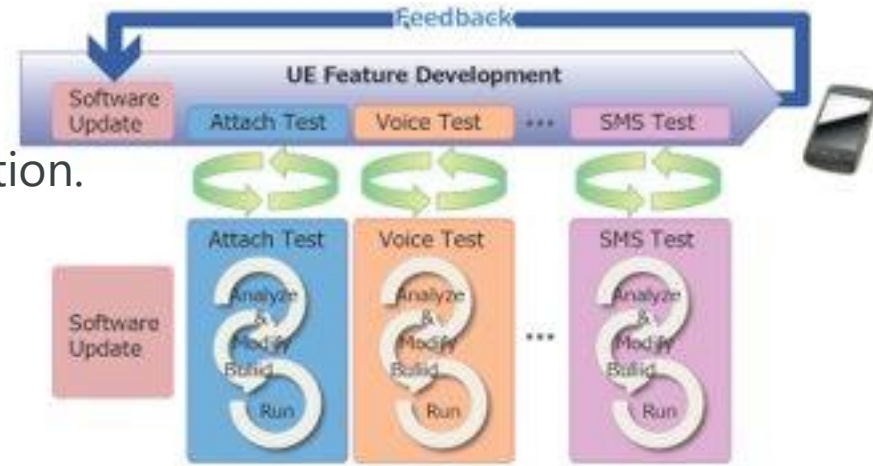

*SSM: MX847503A SmartStudio Manager.

Test sequence editing and execution software for automatic control of MT8000A, MD8475B, UE.

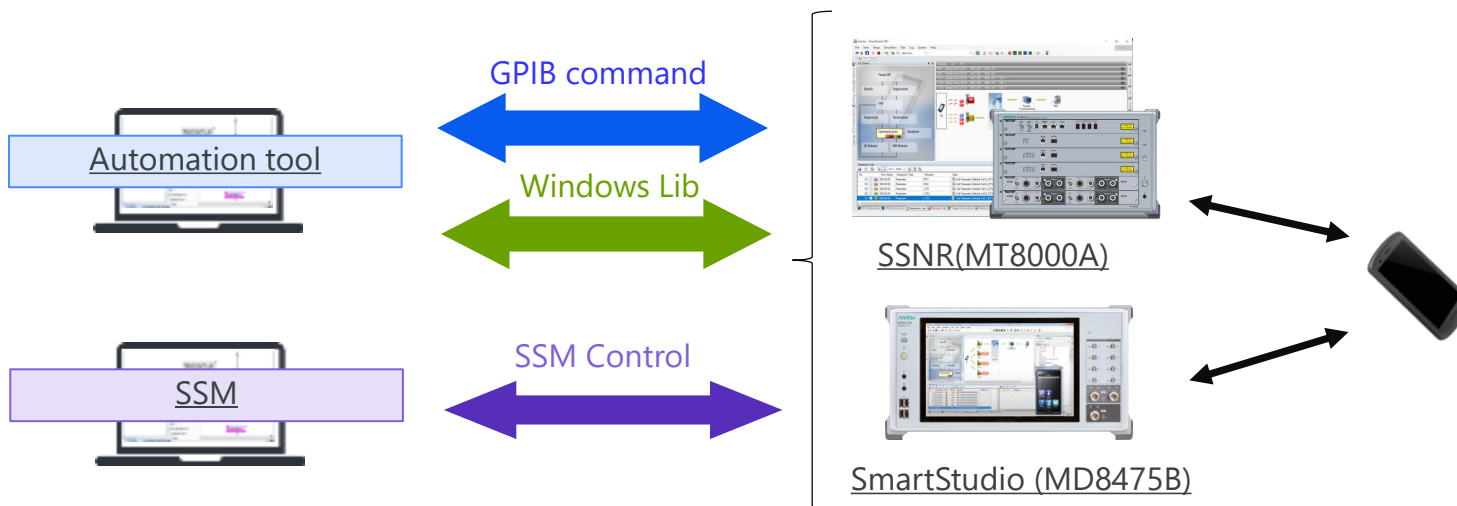

Dual SIM Test Configuration

■ LTE/Legacy + 5G(SA,NSA)/LTE

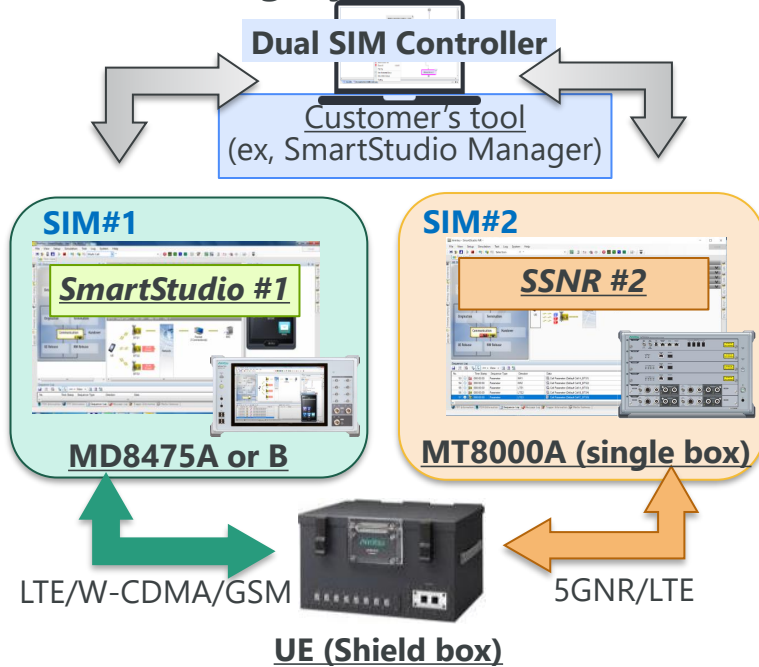

■ 5G(SA,NSA)/LTE + 5G(SA,NSA)/LTE

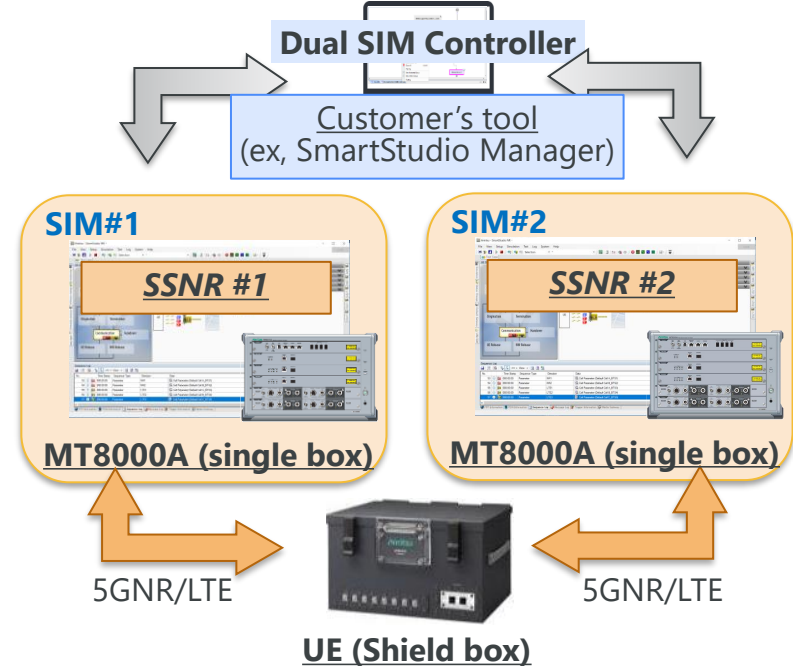

Dual SIM test case (for reference)

SIM#1		SIM#2
Power on Registration		Power on Registration
Data communication		Data communication
Voice call (Origination)		Voice call (Origination)
Voice call (Termination)		Voice call (Termination)
SMS (Sending)		SMS (Sending)
SMS (Receiving)		SMS (Receiving)
Cell Reselection		Cell Reselection
Measurement		Measurement
Handover		Handover

Contents

Market Trend & Anritsu 5G Test Solution

SmartStudio NR Introduction

Appendix - HW/SW total test by one platform

Appendix - SSNR

Appendix - MD8475B Introduction

Support features

		MX800079A (NSA) (v05.00.00.00)	MX800079A (SA) (v05.00.00.00)	MX800078A (NSA) (v05.00.00.00)	MX800078A (SA) (v05.00.00.00)
HW Configuration		MT8000A + MD8475B	MT8000A (+ MD8475B)	MT8000A	MT8000A
NR Features	FDD/TDD CA	Support	Support	Support	Support
	FDD DSS	Support	Support	Support	Support
	FR1 UL 256QAM	Support	Support	Support	Support
	Absolute Frequency SSB	Support	Support	Support	Support
	Arranges UE Cap. Enquiry	Support	Support	Support	Support
	Dynamic Scheduling	Support	Support	Support	Support
	Auto EN-DC Connection	Support	-	Support	-
	Mobility	Support	Support	Support	Support
	EPS-fallback	-	Support ^(*a)	Support	Support
	Network Trigger	Support	Support	Support	Support
	UE Status Change	Support	Support	Support	Support
	NDP/DHCP	Support	Support	Support	Support
NSSAI/S-NSSAI	-	Changeable ^(*b)	-	Changeable ^(*b)	
Applications	SMS	Support	Support	Support	Support
	ETWS/CMAS	Support	Support	Support	Support
	IMS	Support	Support	Support	Support

Note:

(a) Required MD8475B for LTE

(b) Supported by ini.file

SSNR Capability (NR-DC)

						MT8000A FR1 + FR2 HW Capability (*)								
						FR1					FR2(*6)			
Box	RFM (Box1)	BBM (Box1)	Total CC	FR1 CC (*2)	FR2 CC	DL SISO (*3)	DL 2x2	DL 4x4	UL SISO (*4)	UL 2x2 (*4)	DL SISO (*3)	DL 2x2 (*5)	UL SISO (*4)	UL 2x2 (*4)
1box	021/021 (*1)	011/011	2	1	1	1band 1CA	1band 1CA	N/A	1band 1CA	1band 1CA	1band 1CA	1band 1CA	1band 1CA	1band 1CA
1box	021/021 (*1)	011/011	3	1	2	1band 1CA	1band 1CA	N/A	1band 1CA	1band 1CA	1band 2CA	1band 2CA	1band 2CA	1band 2CA
1box	021/021 (*1)	011/011	4	1	3	1band 1CA	1band 1CA	N/A	1band 1CA	1band 1CA	1band 3CA	1band 3CA	1band 3CA	1band 3CA
1box	033/033	011/011	2	1	1	1band 1CA	1band 1CA	1band 1CA	1band 1CA	1band 1CA	1band 1CA	1band 1CA	1band 1CA	1band 1CA
1box	033/033	011/011	3	1	2	1band 1CA	1band 1CA	1band 1CA	1band 1CA	1band 1CA	1band 2CA	1band 2CA	1band 2CA	1band 2CA
1box	033/033	011/011	4	1	3	1band 1CA	1band 1CA	1band 1CA	1band 1CA	1band 1CA	1band 3CA	1band 3CA	1band 3CA	1band 3CA
1box	033/033	011/011	5	1	4	1band 1CA	1band 1CA	1band 1CA	1band 1CA	1band 1CA	1band 4CA	1band 4CA	1band 4CA	N/A

Note:

(*) Indicates Capability from HW perspective.

Please contact M2A for the latest status such as connection results for each CA/MIMO condition.

(*1) Assuming MT8000A-021 is installed.

(*2) FR1 : RF supports up to 2CA.

(*3) RF indicates the number of bands when combined with UL SISO.

(*4) RF indicates the number of bands when combined with DL SISO.

(*5) FR2 : RF converter requires 2sets for 1band 2x2MIMO and 4sets for 2bands 2x2MIMO.

FR2 : RF can be set up to DL 2bands CA.

(*6) Only 100MHz FR2 bandwidth of SSNR is supported.

SSNR Capability (NR Only)

				MT8000A HW Cpability (*)				
				NR (*2)				
RAT	Box	RFM (Box1)	BBM (Box1)	DL SISO (*3)	DL 2x2 (*3, 4)	DL 4x4 (*3)	UL SISO (*5)	UL 2x2 (*5)
FR1	1box	021/021 (*1)	011	2band 2CA	2band 2CA	N/A	2band 2CA	2band 2CA
FR1	1box	021/021 (*1)	011/011	2bands 4CA	2bands 4CA	1band 4CA	2bands 2CA	2bands 2CA
FR1	1box	031	011	2bands 4CA	1band 2CA	1band 2CA	1band 2CA	1band 2CA
FR1	1box	031/032	011/011	4band 4CA	2bands 2CA	2bands 2CA	2bands 2CA	2bands 2CA
FR1	1box	033/033	011/011	4bands 4CA	4bands 4CA	4bands 4CA	2bands 2CA	2bands 2CA
FR1	2box	031/032	011/011	4bands 4CA	4bands 4CA	3bands 4CA	1band 4CA	1band 2CA
FR1	2box	031/032	011/011	4bands 4CA	4bands 4CA	4bands 4CA	1band 4CA	1band 2CA
FR1	1box	021 (*1)	011	2bands 4CA	1band 2CA	N/A	1band 2CA	1band 2CA
FR2	1box	033/033	011/011	1band 8CA	1band 8CA	N/A	1band 4CA	1band 4CA

Note:

(*) Shows HW Capability. Please contact M2A for the latest status such as connection results for each CA/MIMO condition.

(*1) Assuming MT8000A-021 is installed.

(*2) Only 100MHz FR2 bandwidth of SSNR is supported.

(*3) RF indicates the number of bands when combined with UL SISO.

(*4) FR2 : RF converter requires 2sets for 1band 2x2MIMO and 4sets for 2bands 2x2MIMO.

(*5) RF indicates the number of bands when combined with DL SISO.

SSNR Capability (NSASB)

			MT8000A HW Cpability (*)								
			NR (*2)					LTE (*6)			
RAT	RFM (Box1)	BBM (Box1)	DL SISO (*3)	DL 2x2 (*3, 4)	DL 4x4 (*3)	UL SISO (*5)	UL 2x2 (*5)	DL SISO	DL 2x2	DL 4x4	UL SISO
FR1	021/021 (*1)	011/011	1band 4CA	1band 2CA	N/A	1band 4CA	1band 2CA	2bands 3CA	1band 3CA	N/A	2bands 2CA
FR1	031/032	011/011	1band 4CA	1band 4CA	1band 2CA	1band 4CA	1band 2CA	3bands 3CA	2bands 3CA	1band 3CA	2bands 2CA
FR1	033/033	011/011	2bands 4CA	2bands 4CA	2bands 2CA	1band 4CA	1band 2CA	3bands 3CA	2bands 3CA	1band 3CA	1band 1CA
FR2	033/033	011/011	1band 4CA	1band 4CA	N/A	1band 4CA	1band 2CA	3bands 3CA	2bands 3CA	1band 3CA	2bands 2CA

Note:

- (*) Shows HW Capability. Please contact M2A for the latest status such as connection results for each CA/MIMO condition.
- (*1) Assuming MT8000A-021 is installed.
- (*2) Only 100MHz FR2 bandwidth of SSNR is supported.
- (*3) RF indicates the number of bands when combined with UL SISO.
- (*4) FR2 : RF converter requires 2sets for 1band 2x2MIMO and 4sets for 2bands 2x2MIMO.
- (*5) RF indicates the number of bands when combined with DL SISO.
- (*6) Please note that the number of LTE bands that can be supported is limited depending on the bandwidth supported by RFM.

Upgradability from Entry model to Full test configuration for future changes in customer testing needs.

Entry

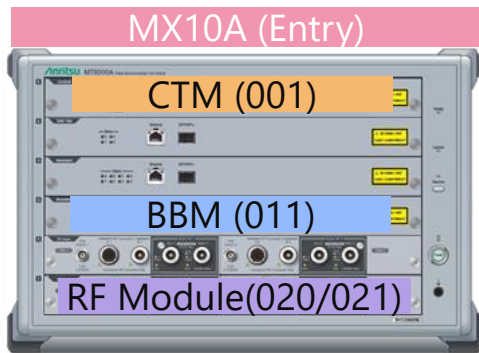

HW/SW Upgrade



Majority

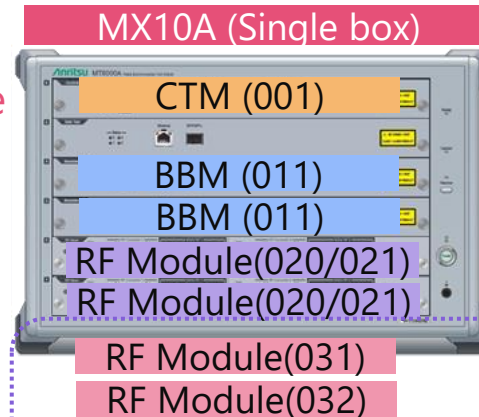

HW/SW Upgrade

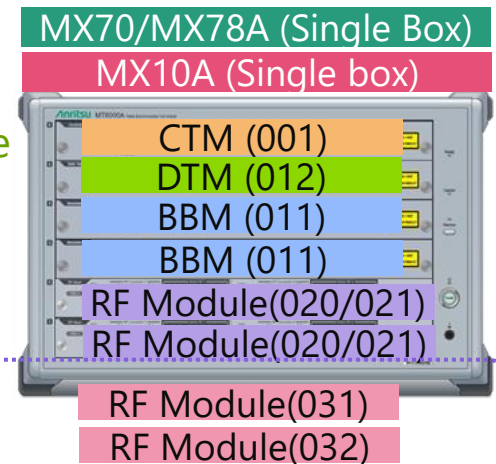

Possible to install 031/032 RF module
Plan to support 033x2 RF module

SW Upgrade



Full MT8000A

MX70/MX79A (w/MD8475B)

MX10A (w/MT8821C)

SW Upgrade



Leading-Edge/Performance

Strong support for device commercialization with two applications focused on each test application

- ✓ HW evaluation including device integration and RF calibration
- ✓ Application evaluation to improve device User experience

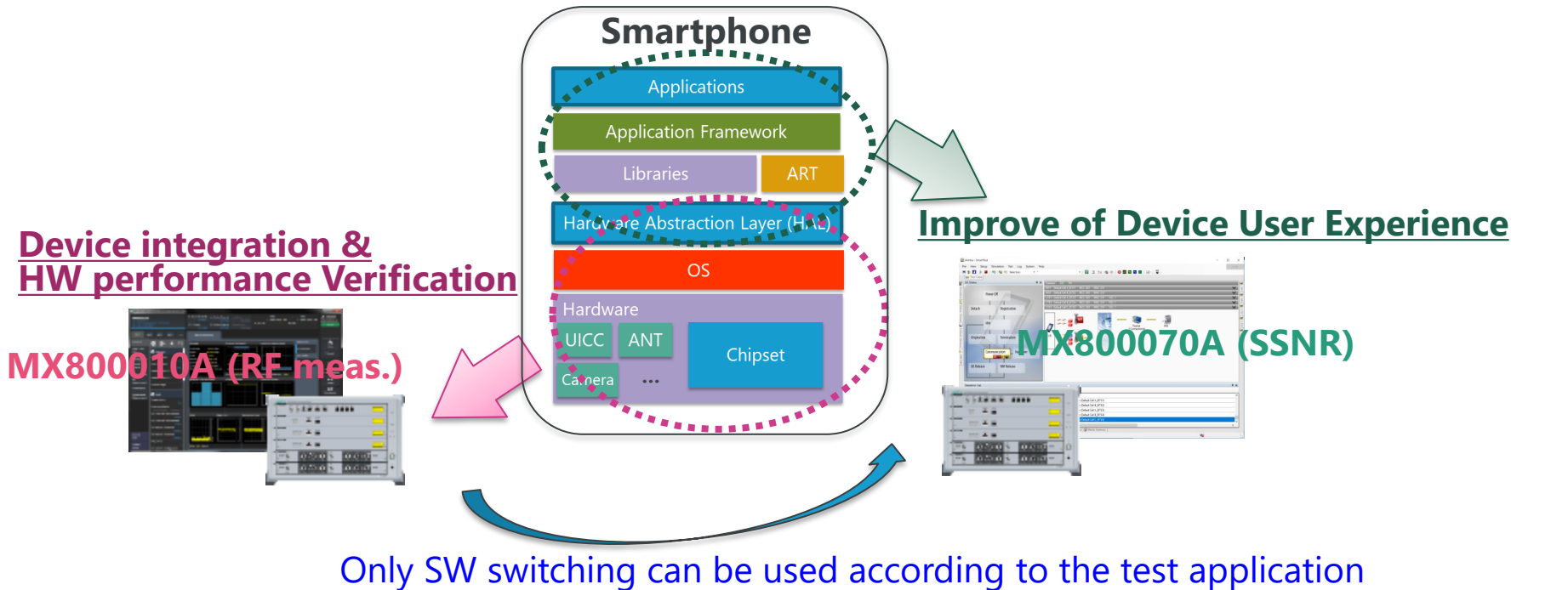

Note : Requires additional HW depend on the customers' instrument

Useful RF test solution for Various use cases.

RF test (TRx test)

OTA/SAR etc

- TRx test (TS38.521) and RF parametric test
- Signaling and non-signaling

- Collaborate with 3rd party for OTA/SAR test area
- Expand to MIMO OTA features

FR1: Conducted



FR2: OTA

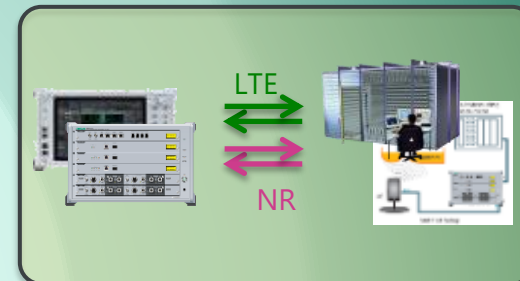
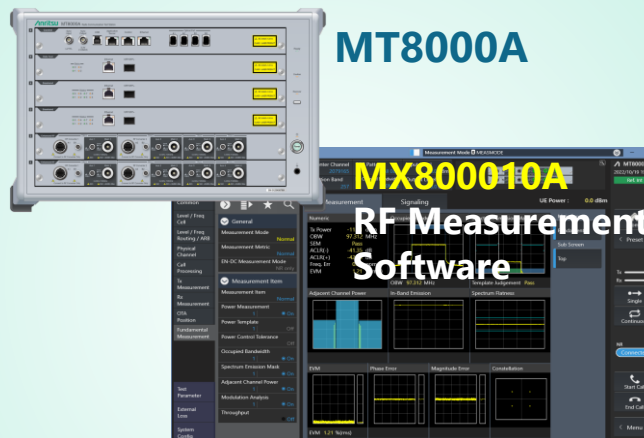

Chipset RF Calibration

- RF Calibration
- RF Characterization

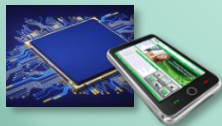

Support FR1 and FR2 for both NSA and SA

For FR1: Support FDD and TDD
(450MHz to 7.125GHz)

For FR2: Support TDD
(24GHz to 43GHz band :n257~n261)

IP Data T-put

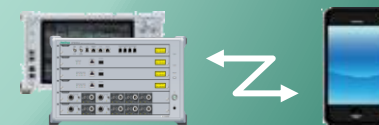

Can be used SSNR for device application test depending on the operating status of MT8000A deployed in the lab.

➔ Contribute to the efficiency of MT8000A platform operation.

RF test



- RF TRx
- OTA test
- SAR/EMC
- ⋮

Only add simple software option



RF + Application Test

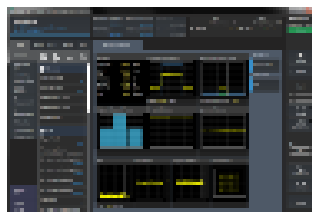

- RF TRx
- OTA test
- SAR/EMC
- ⋮

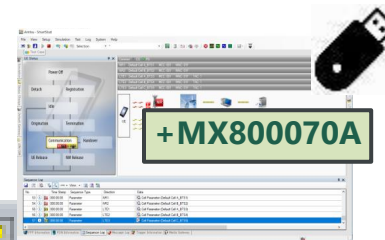
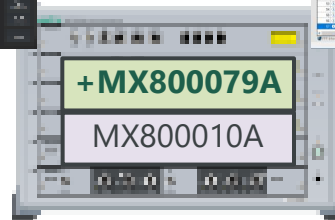

- VoNR
- Messaging
- OTT application
- ⋮

SSNR license is not related to MT8000A platform

➔ Utilize the MT8000A that is available at that time

Contents

Market Trend & Anritsu 5G Test Solution

SmartStudio NR Introduction

Appendix - HW/SW total test by one platform

Appendix - SSNR

Appendix - MD8475B Introduction

MT8000A RF Module Product Overview

033 model (FR1: **16TX**, FR2: **OTA**)

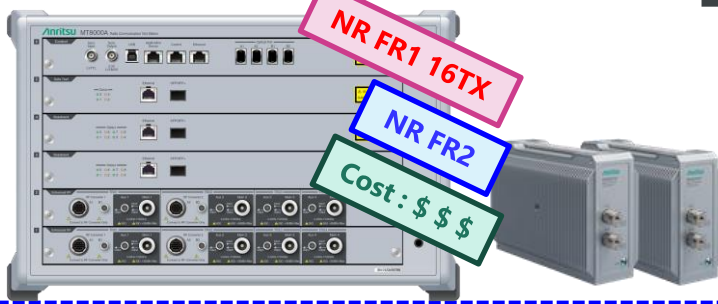

■ Configuration

MT8000A-033 0.4 to 0.7125GHz Enhanced RF Module x2

	Module	0.4 -7.125GHz	IF 6-12GHz	RF Converter
Slot 2	033	8TX(4Port)/4RX	N/A	2
Slot 1	033	8TX(4Port)/4RX	N/A	
Total		16TX(8Port)/8RX	----	2

for Max T-put test by Higher CA & MIMO

031 model (FR1: **8TX**)

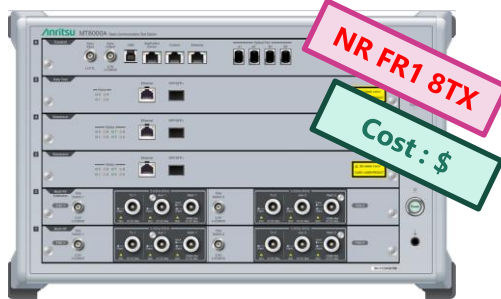

■ Configuration

MT8000A-031 0.4GHz-6GHz Multi RF Module
MT8000A-032 0.4GHz-6GHz Multi RF Extension

	Module	0.4 -6GHz	IF 6-12GHz	RF Converter
Slot 2	031	4TX(4Port)/2RX	N/A	N/A
Slot 1	032	4TX(4Port)/2RX	N/A	N/A
Total		8TX(8Port)/4RX	----	----

for Majority utilization (SW/Application tests)

021 model (FR1: **4TX**, FR2: **OTA**)

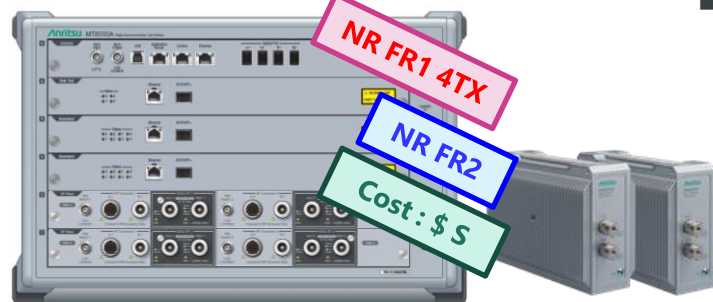

■ Configuration

MT8000A-020 RF Base Module x2
+MT8000A-021 0.4GHz-6GHz RF Sub Module x2

	Module	0.4 -6GHz	IF 6-12GHz	RF Converter
Slot 2	020/021	2TX(2Port)/2RX	N/A	2
Slot 1	020/021	2TX(2Port)/2RX	N/A	
Total		4TX(4Port)/4RX	----	2

MT8000A Platform FW for SSNR

Subject to change

Supported by SW switching for test purposes such as performance evaluation (IP T-put) and application testing.



Platform Capability

RF module	DL / UL CA&MIMO	MX800079A (NR Platform)	MX800078A (NSA Single Box)(*C)
020/021x2 RF	LTE	DL:5CA & 4x4 MIMO, 20Layers, 16Tx ^(*) ^(b) UL:2CA & SISO, 2Tx	DL:3CA & 2x2 MIMO, 2Tx UL:2CA & SISO, 2Tx
	NR FR1	DL:4CA & 4x4 MIMO, 4Tx UL: 2CA & 2x2 MIMO 4Tx	DL:2CA & 2x2 MIMO, 2Tx UL:1CC & 2x2 MIMO 2Tx
	NR FR2	DL:8CA & 2x2 MIMO 4Tx UL:4CA & 2x2 MIMO 4Tx	DL:4CA & 2x2 MIMO 2Tx UL:1CC & 2x2 MIMO 2Tx
031/032 RF	LTE	DL:5CA & 4x4 MIMO, 20Layers, 16Tx ^(*) ^(b) UL:2CA & SISO, 2Tx	DL:3CA & 4x4 MIMO, 4Tx UL:2CA & SISO, 2Tx
	NR FR1	DL:4CA & 4x4 MIMO, 8Tx UL:2CA & 2x2 MIMO 4Tx	DL:2CA & 4x4 MIMO, 4Tx UL:1CC & 2x2 MIMO 2Tx
	NR FR2	Not Supported	Not Supported
033x2 RF	LTE	DL:5CA & 4x4 MIMO, 20Layers, 16Tx ^(*) ^(b) UL:2CA & SISO, 2Tx	DL:3CA & 4x4 MIMO, 8Tx UL:2CA & SISO, 2Tx
	NR FR1	DL:4CA & 4x4 MIMO, 16Tx UL:2CA 2x2 MIMO 8Tx	DL:2CA & 4x4 MIMO, 8Tx UL:1CC 2x2 MIMO 4Tx
	NR FR2	DL:8CA & 2x2 MIMO 16Tx UL:4CA 2x2 MIMO 8Tx	DL:4CA & 2x2 MIMO 8Tx UL: 2CA 2x2 MIMO 4Tx

Note:

- (a) Use internal IP packet for IP data over LTE 800Mbps.
- (b) Required **MD8475Bx2** for more than 16 layers of LTE.
- (c) Please use MD8475B for pure LTE.

Required MD8475B for EN-DC configuration

SSNR Multi-box Configuration

Subject to change

■ MX800079A+MX800079A

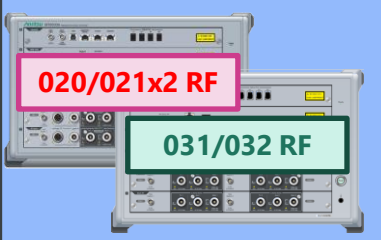
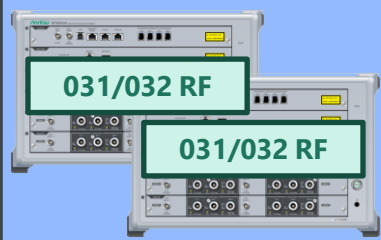
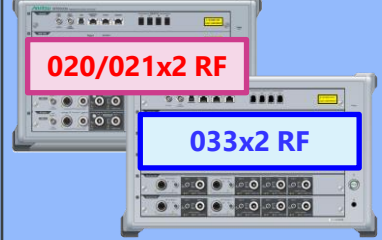
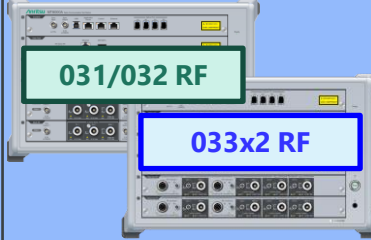
Option 2 SA	MT8000Ax2 (020/021x2 + 031/032) 	MT8000Ax2 (031/032+ 031/032) 	MT8000Ax2 (020/021x2 + 033x2) 	MT8000Ax2 (031/032+ 033x2) 
FR1 3CA	Q1 2022	Q1 2022	-- Supported MT8000Ax1 (033RF model)	-- Supported MT8000Ax1 (033RF model)
FR1 4CA	Q1 2022 (Up to 3band)	Q1 2022	-- Supported MT8000Ax1 (033RF model)	-- Supported MT8000Ax1 (033RF model)
FR1 5CA and over	Not supported	Not supported	Under investigation	Plan to support depending on market trends
FR1/FR2 DC	Under investigation FR1: 3CC (up to 2band) FR2: 8CA	--	Under investigation FR1: 3CA FR2: 8CA	Under investigation FR1: 3CA FR2: 8CA

SSNR SW(~2021)

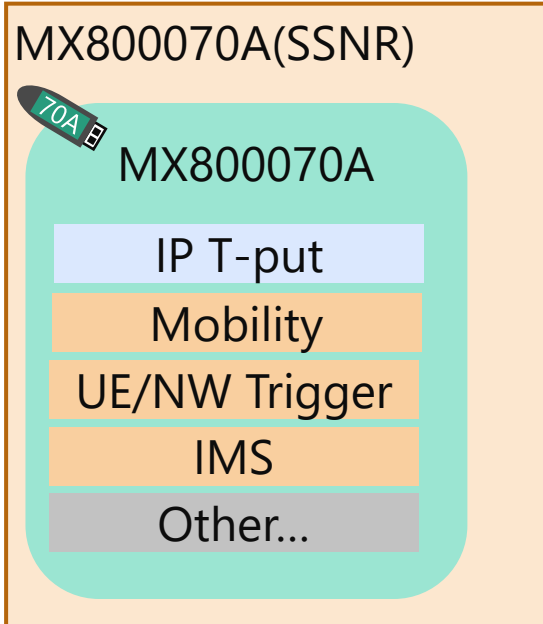

SSNR SW(Q2.2022~)

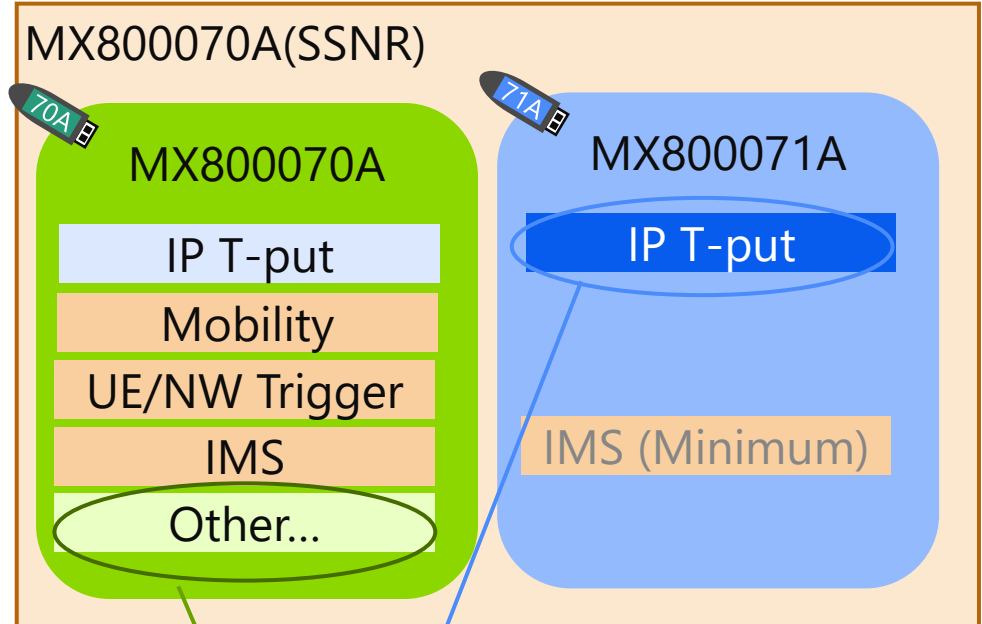

Extended support with MT8000A/LTE
Ex, NW Slicing, WLAN Offload

Scope of application for SW license/support services

SW License/Support service	Application	
	MX800070A	MX800071A
MX800070A(-xx)	✓	✓
MX800071A(-xx)	-	✓

RF Converter Product overview - for FR2

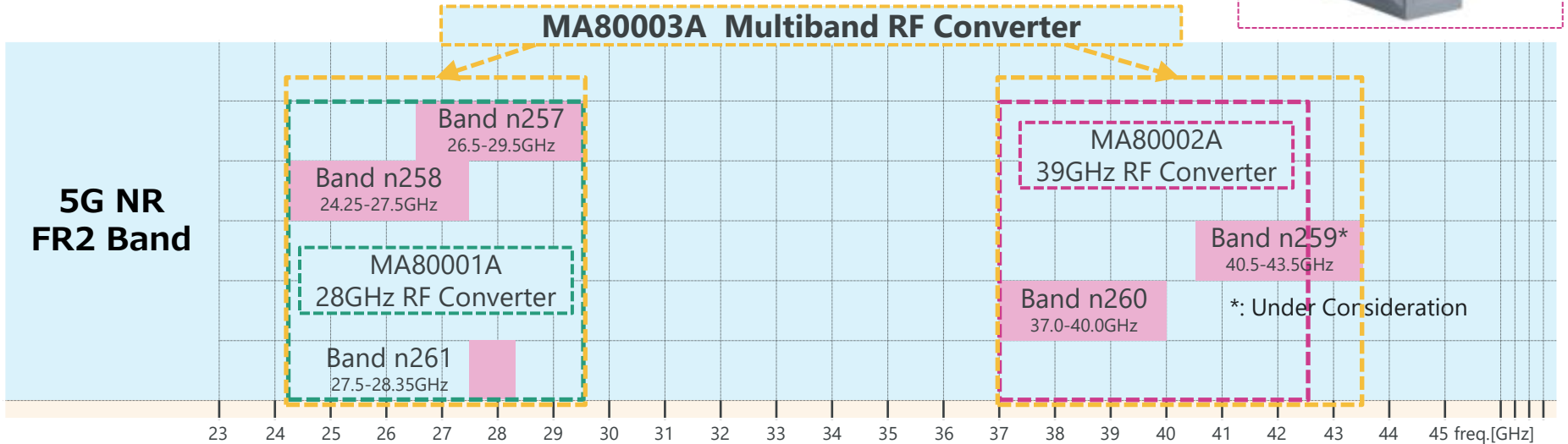

According to the frequency band, 3 types of converters are available.

- ✓ **MA80001A 28GHz RF**
- ✓ **MA80002A 39GHz RF**
- ✓ **MA80003A Multiband RF**



Configuration Example

Use Case	2019 release	Now
24/28GHz	MA80001A	MA80001A
24/28GHz + 39GHz	MA80001A+MA80002A	MA80003A
24/28GHz + 39GHz + 43GHz	---	MA80003A

	MA8161A	MA8171A	MA8172A
Type	Shield Box	Anechoic Chamber	CATR Anechoic Chamber
Figure			
Solution	Protocol Test - IP/PHY Throughput - Function test	Protocol Test - R&D (white box) - PCT/CAT Beam Management - R&D & PCT/CAT	RF Test - R&D (Black box) - RFCT - TRX/Performance
Support Product	MT8000A(RTD/ SSNR)/ME7834NR	MT8000A(RTD)/ME7834NR	MT8000A(RF meas.)/ME7873A
Antenna Type	Spiral Antenna (Max, 2x2 x 4 antennas)	Multi Antenna (Max. 4 antennas)	Reflector Antenna(CATR)
Meas. Condition	White Box (Gray Box)	White Box (Gray Box)	Black Box
	Radiative NFM	Radiative NFM for protocol Test Direct FFM for Protocol & RF Test	Indirect FFM
Measurable DUT Size	15mm(H) * 300(W) * 200(D) mm or less	(Diagonal) 300mm or less	(Diagonal) 330mm or less
OuterSize W*D*H(m)	0.44 x 0.33 x 0.27	2.08 x 1.00 x 1.79 (with rack)	2.20 x 1.20 x 2.00 (with rack)
Weight	≤ 20kg	≤ 240kg	≤ 830kg

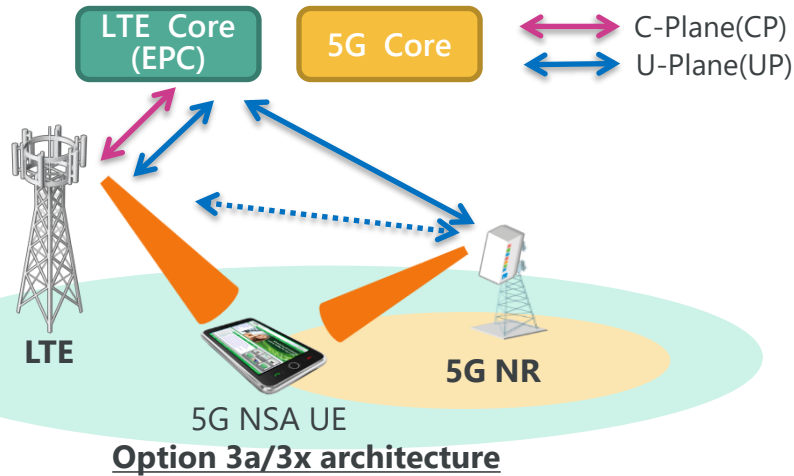

◆ HW/SW configuration

- PC (GUI)
- Support Service
- GUI Opt (Application)
- GUI Opt (NR CA&MIMO)
- SmartStudio NR**

- MD8475B (LTE)
- SmartStudio
- LTE Anchor Option
- LTE SW (CA&MIMO)
- eMSU HW x2

- MT8000A (5GNR)
- GUI I/F
- HW

Option	SA/NSA	Structures			3GPP schedule	Official Terminology
		Core network	CP/UP	Add UP		
Option 1	SA	EPC(LTE)	LTE	---	Support	E-UTRA
Option 2	SA	5G-CN(NR)	NR	---	Jun'18	TBD
Option 3/3a/3x	NSA	EPC(LTE)	LTE	NR	Dec'17	EN-DC ^(*)
Option 4/4a	NSA	5G-CN(NR)	NR	LTE	Jun'18	TBD
Option 5	SA	5G-CN(NR)	LTE	---	TBD	TBD
Option 6	SA	EPC(LTE)	NR	---	TBD	TBD
Option 7/7a	NSA	5G-CN(NR)	LTE	NR	Jun'18	TBD
Option 8/8a	NSA	EPC(LTE)	NR	LTE	TBD	TBD

*E-UTRA-NR Dual Connectivity

EN-DC Throughput Configuration

Option 3x (EN-DC : LTE up to 8 Layers)

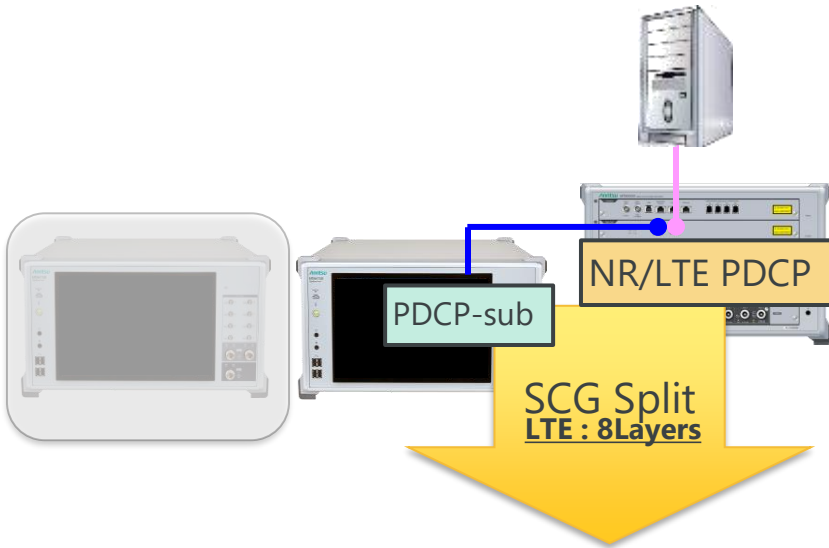

Option 3x (EN-DC : LTE 20 Layers)

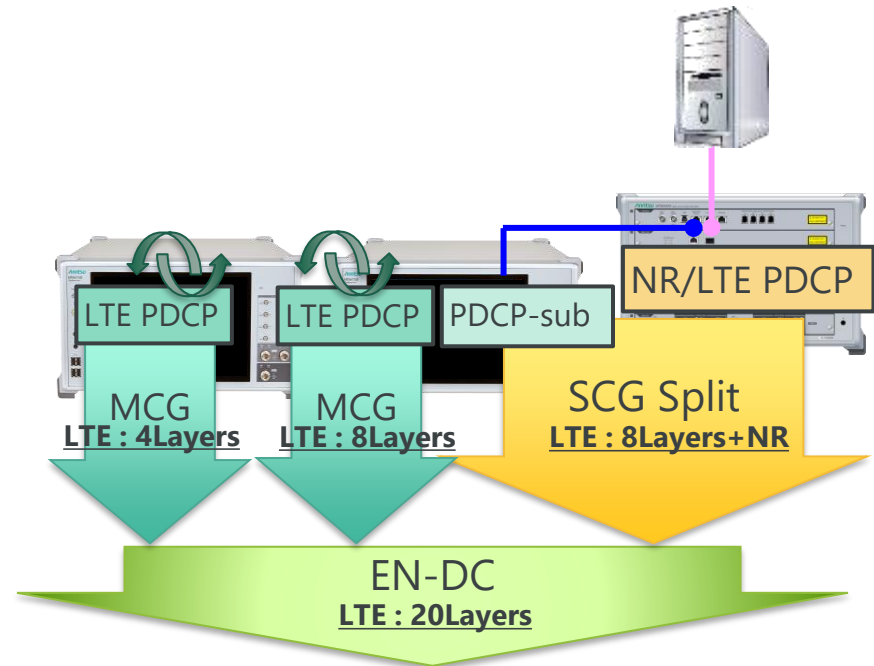

◆ HW/SW configuration

MD8475B (LTE)	MT8000A (NR)
SmartStudio	
LTE Anchor	NR PF for SSNR
LTE (CA&MIMO)	
eMSU HW x2	HW

◆ HW/SW configuration

MD8475B (LTE)	MD8475B (LTE)	MT8000A (NR)
SmartStudio	SmartStudio	
LTE Anchor	LTE Anchor	NR PF for SSNR
LTE (CA&MIMO)	LTE (CA&MIMO)	
eMSU HW x2	eMSU HW x2	HW

DL 3CA (all 256QAM, 20MHz Bandwidth)

Non-contiguous	Supported (6RF)	Supported (8RF)	Supported (10RF)	Supported (12RF)
1-pair contiguous	Supported (4RF)	Supported (6RF)	Supported (6RF)	Supported (8RF)
4x4 MIMO Cell	0	1CC	2CC	3CC
Max Throughput	600 Mbps	800 Mbps	1000 Mbps	1200 Mbps

MD8475B 3 units (24Tx)
MD8475B 2 units (16Tx)
MD8475B 1 unit (8Tx)

DL 4CA (all 256QAM, 20MHz Bandwidth)

Non-contiguous	Supported (8RF)	Supported (10RF)	Supported (12RF)	Supported (14RF)	Supported (16RF)
1-pair contiguous	Supported (6RF)	Supported (8RF)	Supported (10RF) Supported (8RF)	Supported (10RF)	Supported (12RF)
2-pair contiguous	Supported (4RF)	N/A	Supported (6RF)	N/A	Supported (8RF)
4x4 MIMO Cell	0	1CC	2CC	3CC	4CC
Max Throughput	800 Mbps	1000 Mbps	1200 Mbps	1400 Mbps	1600 Mbps

DL 5CA (all 256QAM, 20MHz Bandwidth)

Non-contiguous	Supported (10RF)	Supported (12RF)	Supported (14RF)	Supported (16RF)	Under Consideration (18RF)	Under Consideration (20RF)
1-pair contiguous	Supported (8RF)	Supported (10RF)	Supported (10, 12RF)	Supported (12, 14RF)	Supported (14RF)	Supported (16RF)
2-pair contiguous	Supported (6RF)	Supported (8RF)	Supported (8RF)	Supported (10RF)	Supported (10RF)	Supported (12RF)
4x4 MIMO Cell	0	1CC	2CC	3CC	4CC	5CC
Max Throughput	1000 Mbps	1200 Mbps	1400 Mbps	1600 Mbps	1800 Mbps	2000 Mbps

5G Test Configuration - FR1/FR2 Common

Option 3x EN-DC (with IMS)

Option 3x EN-DC (without IMS)

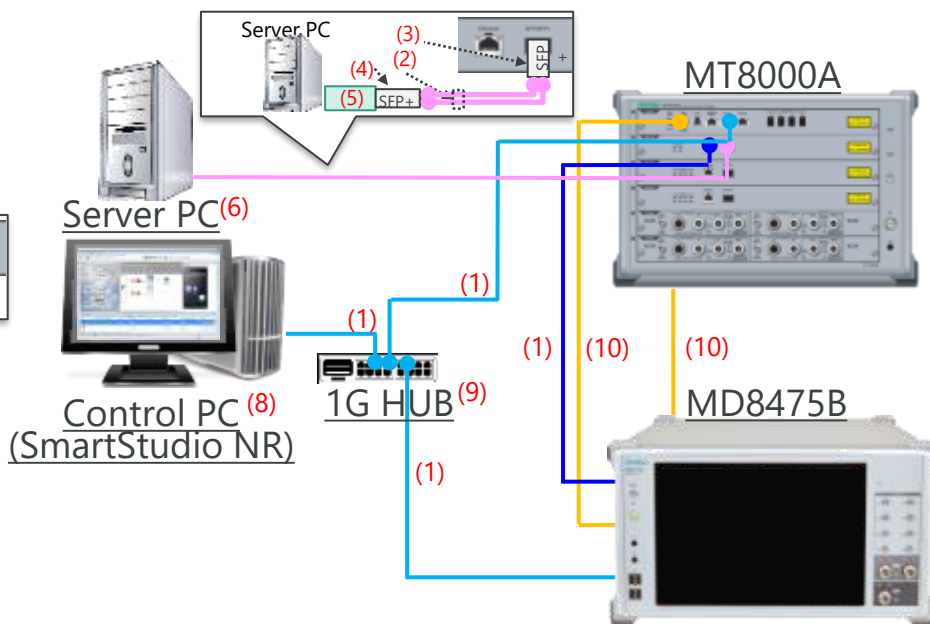
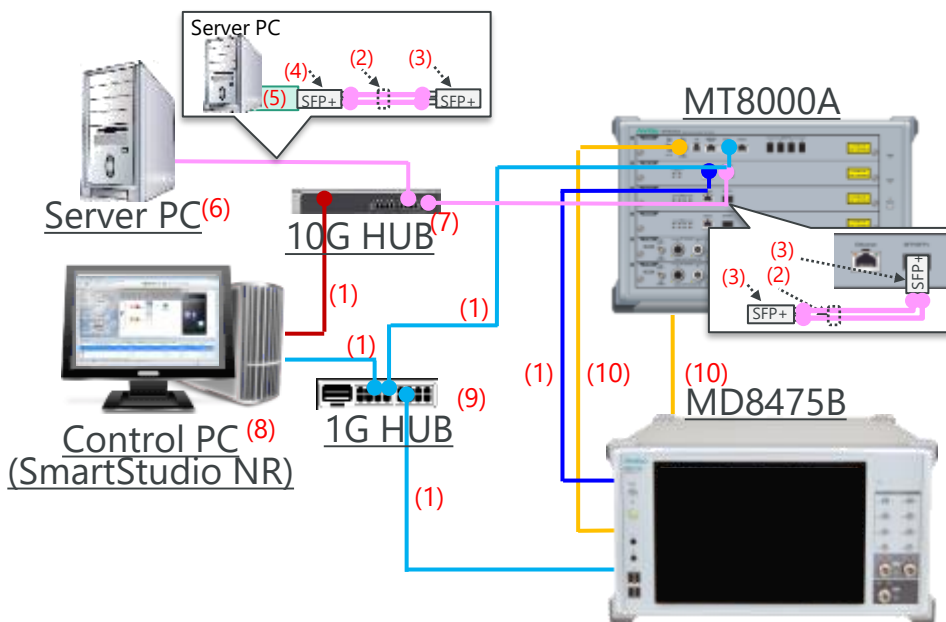

No.	Model Number	Model Name	Qty. (w/IMS)	Note
(1)	J1440A	LAN Cable	5	Control :3(Aqua), IMS :1(Red), NR/LTE :1(Blue)
(2)	J1581A	Optical cable MM LC/PC to LC/PC 3 meter	4	SFP+ Cable
(3)	G0356A	8G FC/10G SR 850 nm SFP+	3	for 10G Switch, MT8000A
(4)	N/A	SFP+ Transceiver	1	for Server
(5)	N/A	10G SFP NIC	1	for Server
(6)	N/A	Server PC	1	
(7)	N/A	10G Ethernet Switching HUB	1	Required SFP port x2 (Ex, NETGEAR XS708T-100AJS)
(8)	N/A	Control PC for SmartStudio	1	Windows 10 64bits
(9)	N/A	1G Ethernet Switching HUB	1	No router functionality
(10)	J0127B	COAXIAL CORD	2	Sync, 10MHz Ref (Yellow)

Qty. (w/o IMS)	Note
4	Control :3(Aqua), NR/LTE :1(Blue)
2	SFP+ Cable
1	for MT8000A
1	for Server
1	for Server
1	
0	Required SFP port x2 (Ex, NETGEAR XS708T-100AJS)
1	Windows 10 64bits
1	No router functionality
2	Sync, 10MHz Ref (Yellow)

Required PC Specification

(6) For Server PC

Item	Specifications
OS	
CPU	• Intel® Xeon® E3-1220 v6 3.0GHz, 8M Cash, 4Core / 4Thread, Turbo (72W)
HDD	• 1 × 500GB SATA, 3.5", 7.2K RPM, 3Gbps,
Memory	• 1 × 8GB UDIMM 2400MT/s, 1R, x8 Data Width
Interface	• SATA DVD+/-RW • Broadcom BCM5720 1Gb Base-T 2port (On board) • 10GbE Ethernet Converged Network Adaptor (SFP+)

Need to check for vendor lock-in between NIC(4) and SFP+ Transceiver(5).

MT8000A-AK002

Items
Dell Power Edge R240 (CentOS 6.9 Linux)
- 540-BBBV Intel Ethernet I350 DP 1Gb Server Adaptor, Low profile
- 10Gtek Transceivers X520-10G-2S-X8 (5)
- WTD RTX228-551 (G0356A) (4)
Optical Cable
- LC.PC-LC.PC(MM3M)Fiber (J1581A) (2)
SFP+ Transceiver for MT8000A
- WTD RTX228-551 (G0356A) (3)

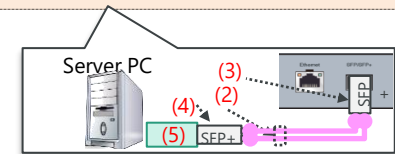

(8) For control PC (SmartStudio NR)

Item	Specifications
OS	• Windows 10 64bit
CPU	• Intel Core i7 or more (recommendation)
HDD	• 500 GB 2.5 inch SATA HDD (7200 rpm) or more
Memory	• 8 GB (4 GB x 2) or more • Non-ECC DDR3 1600 MHz SDRAM Memory
LCD size	• 24" Monitor with screen resolution 1920 x 1080



Z2035A

Items
Dell Optiplex XE3 (Windows 10 64bit) with monitor
- 540-BBMO Kit - Intel 1GB SP PCIe Network card

5G Test Configuration - FR1

EN-DC Throughput Test

Sub 6GHz(4x4MIMO)/LTE 8Layers

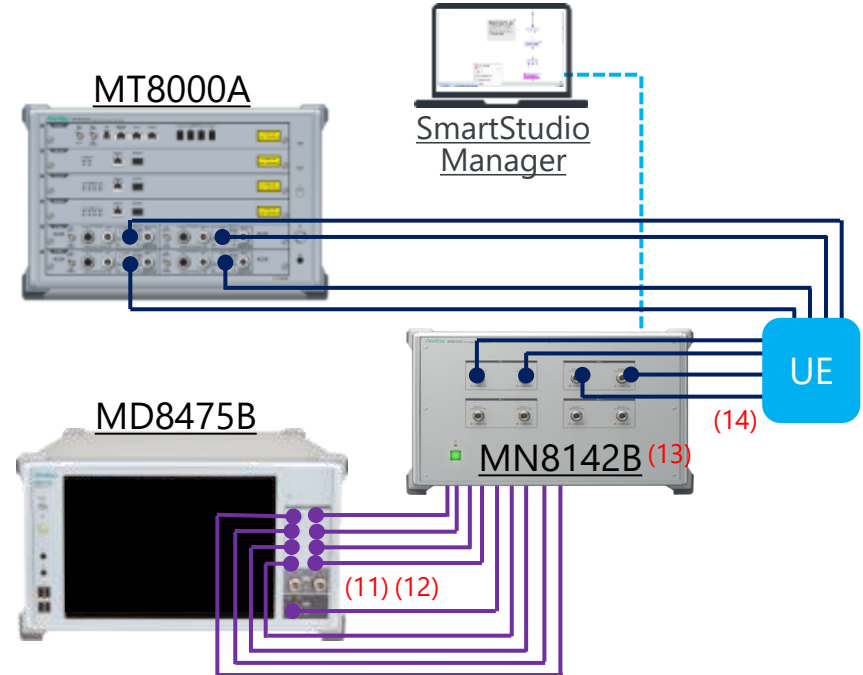
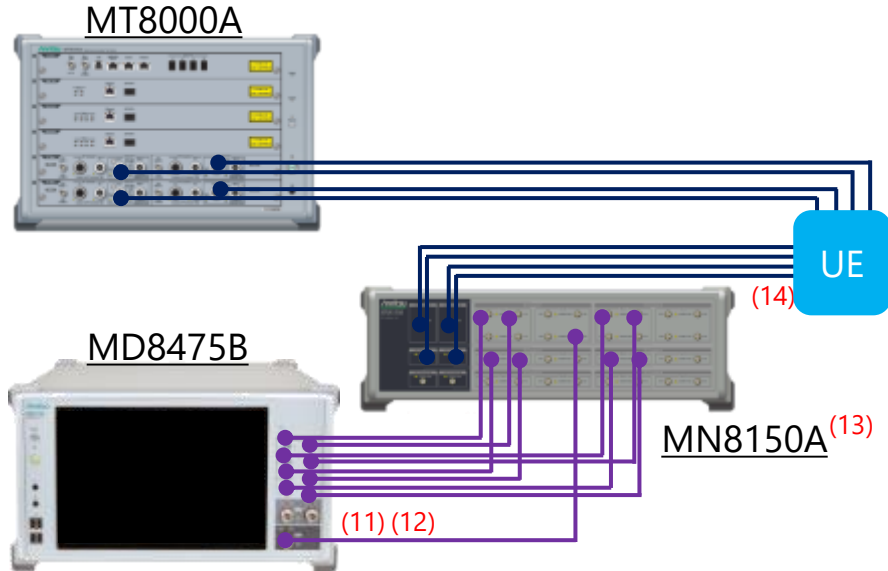

No.	Model Number	Model Name	Qty.	Note
(11)	J1398A	N-SMA ADAPTOR	5	MT8000A :4, MD8475B :1,
(12)	J1674A	SMA/P-SMA/P Soft Rigid Cable	9	MD8475B :9
(13)	MN8150A	RF Combiner Unit	1	
(14)	N/A	UE Cable	8	SMA type

No.	Model Number	Model Name	Qty.	Note
(11)	J1398A	N-SMA ADAPTOR	5	MT8000A :4, MD8475B :1,
(12)	J1674A	SMA/P-SMA/P Soft Rigid Cable	9	MD8475B :9
(13)	MN8142B	RF Combiner Unit	1	
(14)	N/A	UE Cable	8	SMA type

■ EN-DC Throughput Test

mmW (2x2MIMO)/LTE 8Layers

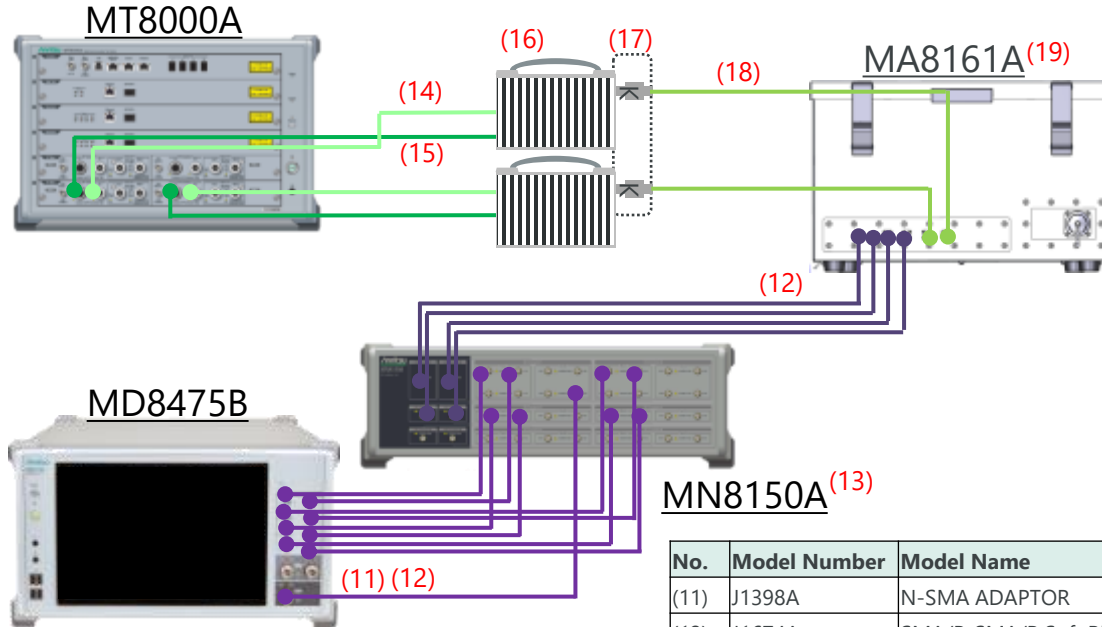

MN8150A⁽¹³⁾

No.	Model Number	Model Name	Qty.	Note
(11)	J1398A	N-SMA ADAPTOR	1	MD8475B :1,
(12)	J1674A	SMA/P-SMA/P Soft Rigid Cable	13	MD8475B :9, MN8150A :4
(13)	MN8150A	RF Combiner Unit	1	
(14)	J1771B	Coaxial Cord (N-N, 3.0m)	2	IF Signal to Converter (Light green)
(15)	J1772B	Control Cable, 3.0m	2	Control to Converter (Green)
(16)	MA80001A /MA80002A	28GHz RF Converter/ 39GHz RF Converter	2	
(17)	K222B	Precision Adapter	2	KF-KF Connector. Standard accessories (MA80001A)
(18)	J1775A (J1775B)	Coaxial Cable (KM-KM, 0.3m) (Coaxial Cable (KM-KM, 1m))	2 (2)	mmWave RF cable
(19)	MA8161A	Shield Box	1	with Antenna Unit

SmartStudio vs SSNR

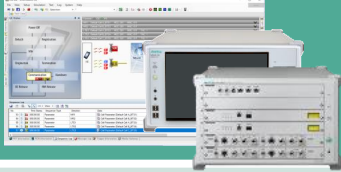
	SmartStudio 	SSNR 	Remarks
Legacy(2G/3G)	Supported	-	
LTE	Supported	Supported	
LTE-A	Supported (5CC&20Layers)	Supported (5CC&20Layers)	
5G NR (NSA)	-	Supported (Option 3, 3a, 3x)	
5G NR (SA)	-	Supported (Option 2)	
Mobility	-	-	-
LTE P-cell HO	Supported	Supported	Up to 2CC&2x2MIMO
LTE S-cell Add	Supported	Supported	Up to 3CC&8layers
LTE S-cell Release	Supported	Supported	Up to 3CC&8layers
LTE S-cell Switch	Supported	Supported	Up to 2CC&2x2MIMO
NR Add (EN-DC connection)	-	Supported	
NR Release (LTE connection)	-	Supported	
NR Switch (PS-sell Switch)	-	Supported	
Inter-RAT HO to 2G/3G	Supported	-	
Application	-	-	-
Network Failure(Abnormal)	Supported	Supported	
SMS	Supported	Supported	
PWS	Supported	Supported	
IMS (Server)	Supported	Supported	
IMS (Script)	Supported	Supported	
RCS	Supported	-	
Wi-Fi Offload	Supported	-	

Support status of IMS features

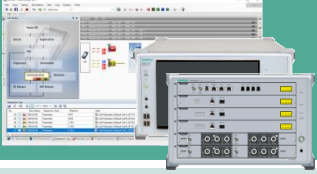
	SmartStudio 	SSNR 	Remarks
Legacy(2G/3G)	Supported	-	
LTE	Supported	Supported	
LTE-A	Supported (5CC&20Layers)	Supported (5CC&20Layers)	
5G NSA	-	Supported (Option 3x)	
5G SA	-	Supported (Option 2)	
IMS Services	-	-	-
IP Address Setting	IPv4 : 3, IPv6 : 3	IPv4 : 3, IPv6 : 3	
CSCF	Support	Support	
DHCPv6	Support	Support	
DNS	Support	Support	
MWI	Limited Support	Limited Support	Only notifies is supported. (3GPP TS 24.606 Rel10 only)
NDP	Support	Support	
NTP	Support	Support	
PSAP	Support	Support	
RCS	Support	-	
VoLTE Conference	Support	Support	
XCAP	Support	Support	
BSF	Support	Support	
MRF	Support	Support	
IMS Script	Support	Support	
RTP	Support	Support	

Difference between RTD and SmartStudio in UE software(protocol) test.

Protocol model (RTD)

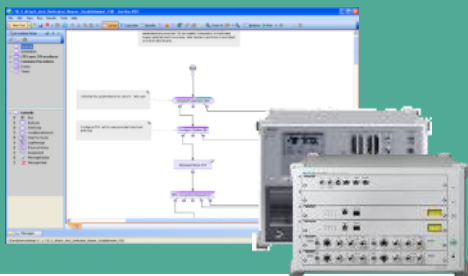

- ✓ It is necessary to create each test case by the user
 - Deep knowledge of 3GPP protocol required

- ✓ Test scripts can be created using flow chart interface, **supporting high flexibility and scalability.**
 - Possible to check user-specific abnormal tests and protocol message at one by one.

Check at protocol message level

- Chipset R&D
- Chipset integration to the UE in the early phase

Function Model (SmartStudio NR)

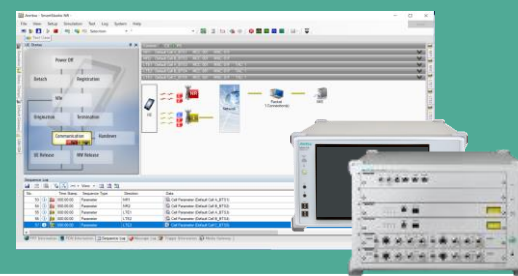

- ✓ Interactive test environment **without complicated test scripts**
- ✓ Possible to test for UE function(Voice, data communication, Messaging...) without requiring deep knowledge of protocol
- ✓ Abnormal test for user specific doesn't support (Some abnormal tests are supported by SmartStudio GUI.)

Check as UE function

- UE application test
- UE regression test on software update
- UE maintenance (ex, localization)

Contents

Market Trend & Anritsu 5G Test Solution

SmartStudio NR Introduction

Appendix - HW/SW total test by one platform

Appendix - SSNR

Appendix - MD8475B Introduction

MD8475B Signalling Tester Product Overview

- ◆ Equipped with **8TX/4RX** RFs for carrier aggregation
- ◆ Support **LTE-Advanced 4CCs 4x4MIMO (16layers)** in single box
- ◆ **Multi-system capable platform**
 - W-CDMA/HSPA/HSPA evo/DC-HSDPA, GSM/GPRS/EGPRS
 - CDMA2000 1X/EV-DO, TD-SCDMA/HSPA
 - 5GNR-NSA (w/ MT8000A)
- ◆ **Easy operation with State-machine based GUI “SmartStudio”**
- ◆ **2-cell IntraRAT / InterRAT capable platform**
 - 2-cell/3-cell IntraRAT: LTE 3-cell, W-CDMA 2-cell, GSM 2-cell , TD-S 2-cell
 - 2 system InterRAT: LTE/LTE/W, LTE/LTE/G, LTE/LTE/C2K, LTE/LTE/TD
- ◆ **Built-in IMS service function**
 - CSCF/DHCP/DNS Server functions
 - NDP/XCAP/GBA/Early Media function
 - IMS Supplementary Service
 - RTP control for VoLTE quality test
 - RCS (Rich Communication Suite)
 - Script-based I/F for advanced test
- ◆ **Built-in SMS center**
- ◆ **Built-in PWS center**
 - ETWS (LTE/W-CDMA/GSM)
 - CMAS (LTE/W-CDMA/GSM/cdma2000)
- ◆ **Built-in UE/Network Trigger function**
 - Sub-normal condition(LTE/W-CDMA/GSM/TD-SCDMA))

◆ **WLAN Offloading**

- EAP authentication
- ePDG access
- ANDSF policy distribution

◆ **Automation**

- Remote control of SmartStudio
- Script-based automation engine
- Included more than sample 180 TCs



SmartStudio

No new sales for CDMA2000

SmartStudio - Easy Operation with State-Machine GUI

- Interactive test environment **without complex test scripts**
- Built-in IMS server
- Unique graphical SMS/PWS Centre applications for SMS/CMAS/ETWS service
- Network parameter settings matching user test environment
- Automatic call setting matching DUT ability

Various System Configurations (InterRAT/IntraRAT condition)

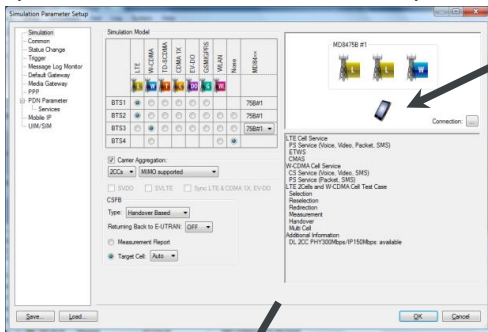

Extensive Network Parameters

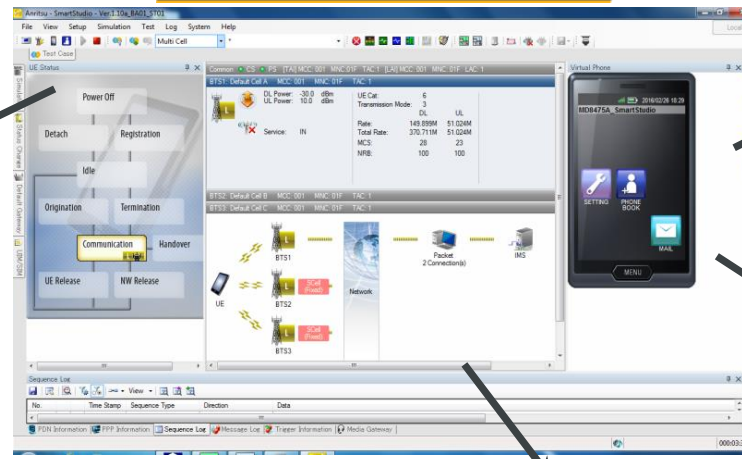

IMS Services

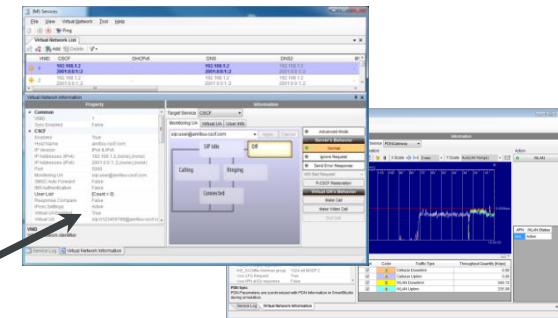

WLAN Offload services

SMS Centre

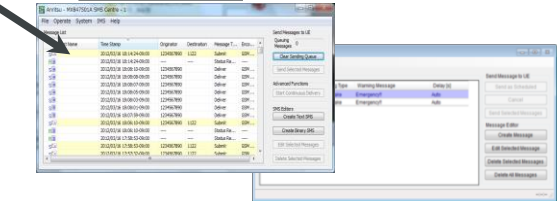

PWS Centre

UE/Network Trigger(Abnormal Condition)

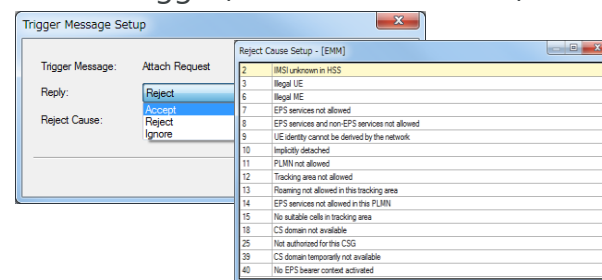

No new sales for CDMA2000

Key Feature and Specification of MD8475A/B

			MD8475B	MD8475A (Discontinued)
Maximum # of RFs			8TX/4RX	2TX/2RX
TX	Frequency		350 MHz to 6 GHz	350 MHz to 3.6 GHz
	Level	MAIN AUX1/2	-130 to -27 dBm (to 3.8 GHz) -130 to -32 dBm (3.8 GHz to 6 GHz) *G/C2k: -130 to -25 dBm	-130 to -10 dBm
		DL Out1-8	-115 to -5 dBm (to 3.8 GHz) -115 to -10 dBm (3.8 GHz to 6 GHz)	—
RX	Frequency		350 MHz to 6 GHz	350 MHz to 3.6 GHz
	Level	MAIN AUX1/2	-60 to +35 dBm -30 to +40 dBm (GSM: in-burst average)	-60 to +35 dBm -30 to +40 dBm (GSM: in-burst average)
Signalling Unit			eMSU(MD8475B-071)	MSU(MD8475A-070)
LTE			Support	Support
IP Traffic Generator			Support	Not support
UE DL Category			1 to 7, 9 to 13, 15, 16, 18, 19, 20	1 to 4 and 6 (2box)
Maximum number of CCs			5	2
Antenna connection			SISO, 2x2 MIMO, 4x4 MIMO	SISO, 2x2 MIMO
Modulation			64QAM, 256QAM	64QAM
FDD/TDD joint CA			Support	Not support
LAA			Support	Not support
UE UL Category			1 to 7, 9 to 13	1 to 4 and 6 (2box)
Maximum number of CCs			2	2 (*1)
Modulation			16QAM, 64QAM	16QAM
W-CDMA			Support	Support
GSM			Support	Support
TD-SCDMA			Support	Support
SSNR			Support	Not support

(*1)Maximum throughput is up to 50Mbps

LTE-A CA & MIMO Status (MD8475B/eMSU)

DL 3CA (all 256QAM, 20MHz Bandwidth)

Non-contiguous	Supported (6RF)	Supported (8RF)	Supported (10RF)	Supported (12RF)
1-pair contiguous	Supported (4RF)	Supported (6RF)	Supported (6RF)	Supported (8RF)
4x4 MIMO Cell	0	1CC	2CC	3CC
Max Throughput	600 Mbps	800 Mbps	1000 Mbps	1200 Mbps

MD8475B
3 units (24Tx)

MD8475B
2 units (16Tx)

MD8475B
1 unit (8Tx)

DL 4CA (all 256QAM, 20MHz Bandwidth)

Non-contiguous	Supported (8RF)	Supported (10RF)	Supported (12RF)	Supported (14RF)	Supported (16RF)
1-pair contiguous	Supported (6RF)	Supported (8RF)	Supported (10RF) Supported (8RF)	Supported (10RF)	Supported (12RF)
2-pair contiguous	Supported (4RF)	N/A	Supported (6RF)	N/A	Supported (8RF)
4x4 MIMO Cell	0	1CC	2CC	3CC	4CC
Max Throughput	800 Mbps	1000 Mbps	1200 Mbps	1400 Mbps	1600 Mbps

DL 5CA (all 256QAM, 20MHz Bandwidth)

Non-contiguous	Supported (10RF)	Supported (12RF)	Supported (14RF)	Supported (16RF)	Under Consideration (18RF)	Under Consideration (20RF)
1-pair contiguous	Supported (8RF)	Supported (10RF)	Supported (10, 12RF)	Supported (12, 14RF)	Supported (14RF)	Supported (16RF)
2-pair contiguous	Supported (6RF)	Supported (8RF)	Supported (8RF)	Supported (10RF)	Supported (10RF)	Supported (12RF)
4x4 MIMO Cell	0	1CC	2CC	3CC	4CC	5CC
Max Throughput	1000 Mbps	1200 Mbps	1400 Mbps	1600 Mbps	1800 Mbps	2000 Mbps

Server mode

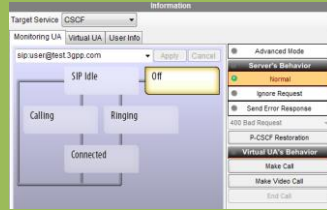

- ✓ Interactive test environment **without complicated test scripts**
- ✓ Possible to test for IMS function (VoLTE, SMS) without requiring deep knowledge of protocol

- ✓ Abnormal test for user specific doesn't support (Some abnormal tests are supported by Extended CSCF option.)
- ✓ Doesn't support operator-specific information. (Can't support ...)

Script mode

Step	Direction	Server	Message	Note
1				Script : SMS_OVER_IMS_MO_AUTH
2				Power on UE
3	→	CSCF1	REGISTER * SIP/2.0	1st REGISTER
4	←	CSCF1	SIP/2.0 401 Unauthorized	Unauthorized
5	→	CSCF1	REGISTER * SIP/2.0	2nd REGISTER
6	←	CSCF1	SIP/2.0 200 OK	REGISTER
7	→	CSCF1	SUBSCRIBE * SIP/2.0	SUBSCRIBE
8	←	CSCF1	SIP/2.0 200 OK	SUBSCRIBE
9	→	CSCF1	NOTIFY sip:100RME.CALLINGNO@%L SIP/2.0	

- ✓ It is necessary to create a test case by the user
 - Deep knowledge of IMS protocol required
 - * Providing technical support service separately

Help to create test case by "Log Import Option"

- ✓ Scripts can be created using a ladder sequence, **supporting high flexibility and scalability.**
 - Possible to check user-specific abnormal tests and protocol check at any message level.
 - Call processing of LTE is by using the SmartStudio, the user can focus on function of IMS development and evaluation.

Application example :

Regression test for each operator using the automation tool (SmartStudio Manager)

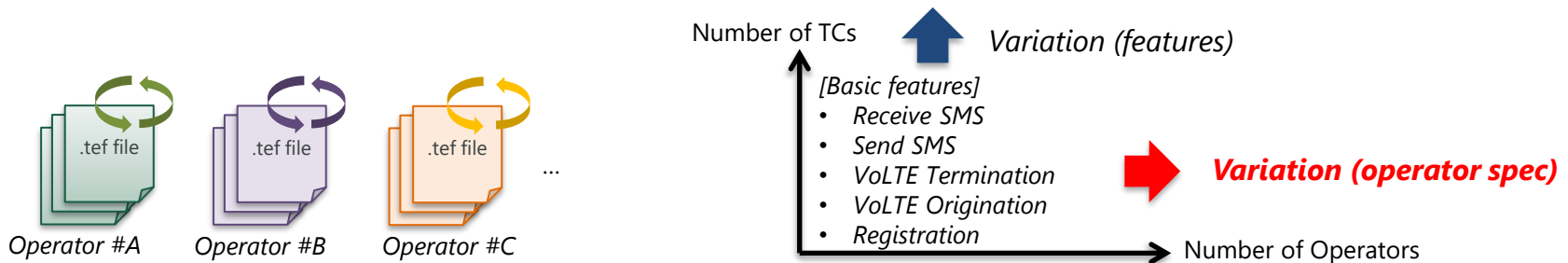

IMS Script/Log Import (MD8475B Option)

Key Features

- Fully automated IMS script file (.tef file) creation tools
- Supports SIP protocol and XCAP protocol
- Converted from Wireshark Log captured in live network operation
- An encrypted message can be converted with key value set
- Automates SmartStudio control (LTE) part during converting process
- Converted message can be edited in message level using the Add-in Server window
- Listed as a one of MD8475"B" ordering (Cost Option)

Wireshark log

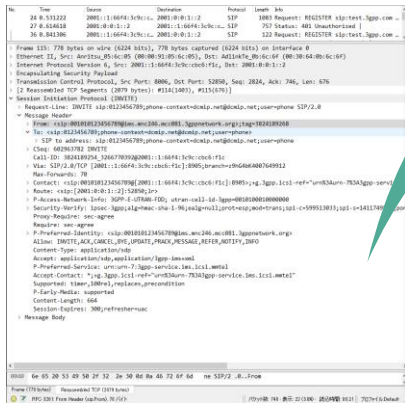

Import

Step	Direction	Server	Message	Note
1			<Remark>	Script : VOICE_MO_AUTH
2			<Remark>	Power on UE
3	→	CSCF1	REGISTER * SIP/2.0	1st REGISTER
4	←	CSCF1	SIP/2.0 401 Unauthorized	Unauthorized
5	→	CSCF1	REGISTER * SIP/2.0	2nd REGISTER
6	←	CSCF1	SIP/2.0 200 OK	REGISTER
7	→	CSCF1	SUBSCRIBE * SIP/2.0	SUBSCRIBE
8	←	CSCF1	SIP/2.0 200 OK	SUBSCRIBE
9	←	CSCF1	NOTIFY sip:107@DEFININGNO%@% SIP/2.0	NOTIFY
10	→	CSCF1	SIP/2.0 200 OK	NOTIFY
11			<Remark>	Outgoing call: 1111
12	→	CSCF1	INVITE * SIP/2.0	
13	←	CSCF1	SIP/2.0 100 Trying	
14			<SmartStudio> SET_TERMINATION	Terminate audio bearer
15	←	CSCF1	SIP/2.0 183 Session Progress	
16	→	CSCF1	PRACK * SIP/2.0	
17	←	CSCF1	SIP/2.0 200 OK	PRACK
18	→	CSCF1	UPDATE * SIP/2.0	
19			<SmartStudio> UPDATE_TERMINATION	Terminate audio bearer
20	←	CSCF1	SIP/2.0 200 OK	UPDATE
21	←	CSCF1	SIP/2.0 180 Ringing	
22	→	CSCF1	PRACK * SIP/2.0	
23	←	CSCF1	SIP/2.0 200 OK	PRACK
24	←	CSCF1	SIP/2.0 200 OK	INVITE
25	→	CSCF1	ACK * SIP/2.0	
26			<Remark>	Voice call UE
27	→	CSCF1	BYE * SIP/2.0	
28			<SmartStudio> SET_RELEASE_FROM IMS	Release audio bearer
29	←	CSCF1	SIP/2.0 200 OK	BYE

IMS Script

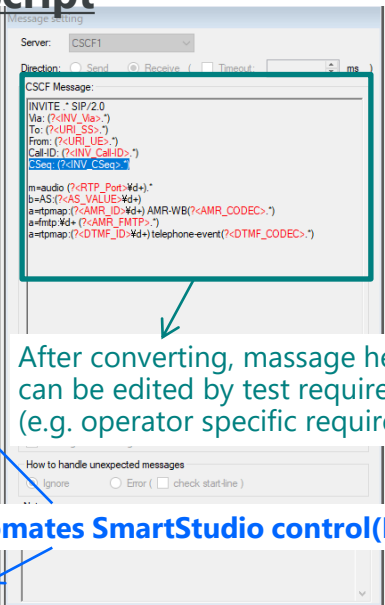

After converting, message header can be edited by test requirements (e.g. operator specific requirements)

Automates SmartStudio control (LTE) part

■ RTP Frame Control Option (MD8475A/B support)

Support evaluation for the purpose of differentiation in terms of quality in the VoLTE function.

■ VoLTE Loopback

Supports both VoLTE and ViLTE calls.



DL: Loopback voice/video

UL: Voice/video



Supports data delay or/and packet loss condition

■ Mute/Silent (DTX)

Support test environment simulating silent state



DL: SID frame

UL: Voice



■ Fixed Pattern

Simulation of calls that imagined various voices (ex. Woman's voice (high tone), man's voice (low tone))



DL: Fixed pattern

UL: Voice



■ No Data

Check the operation of the UE in no received data condition.



DL: No data

UL: Voice



■ Text Data for RTT (Real-time text)

This mode transmits text data to UE by RTT.



DL : Text (user data)

UL : Text



■ Binary Data

This mode transmits binary data to UE.



DL : Binary (user data)

UL : Voice/Video/Text





Anritsu
Advancing beyond

The Anritsu logo features the word 'Anritsu' in a bold, green, sans-serif font. The letter 'A' is stylized with a diagonal slash. Below the logo is the tagline 'Advancing beyond' in a black, sans-serif font. The background is a light gray gradient with a decorative graphic of several curved, parallel lines in shades of green and yellow on the right side.