

Anritsu Advancing beyond

VectorStar™

Opto-electronic Network Analyzer

ME7848A/E

VNA, O/E Calibration Module, and E/O Converter:

ME7848A/E-0210	110 GHz, 1550 nm System
ME7848A/E-0211	110 GHz, 1310 nm System
ME7848A-0240	40 GHz, 850 nm System
ME7848A-0270	70 GHz, 1550 nm System
ME7848A-0271	70 GHz, 1310 nm System
ME7848A-0272	70 GHz, 1310/1550 nm System

VNA and O/E module only:

ME7848A/E-0110	110 GHz, 1550 nm System
ME7848A/E-0111	110 GHz, 1310 nm System
ME7848A/E-0112	110 GHz, 1310/1550 nm System
ME7848A-0140	40 GHz, 850 nm System
ME7848A-0170	70 GHz, 1550 nm System
ME7848A-0171	70 GHz, 1310 nm System
ME7848A-0172	70 GHz, 1310/1550 nm System

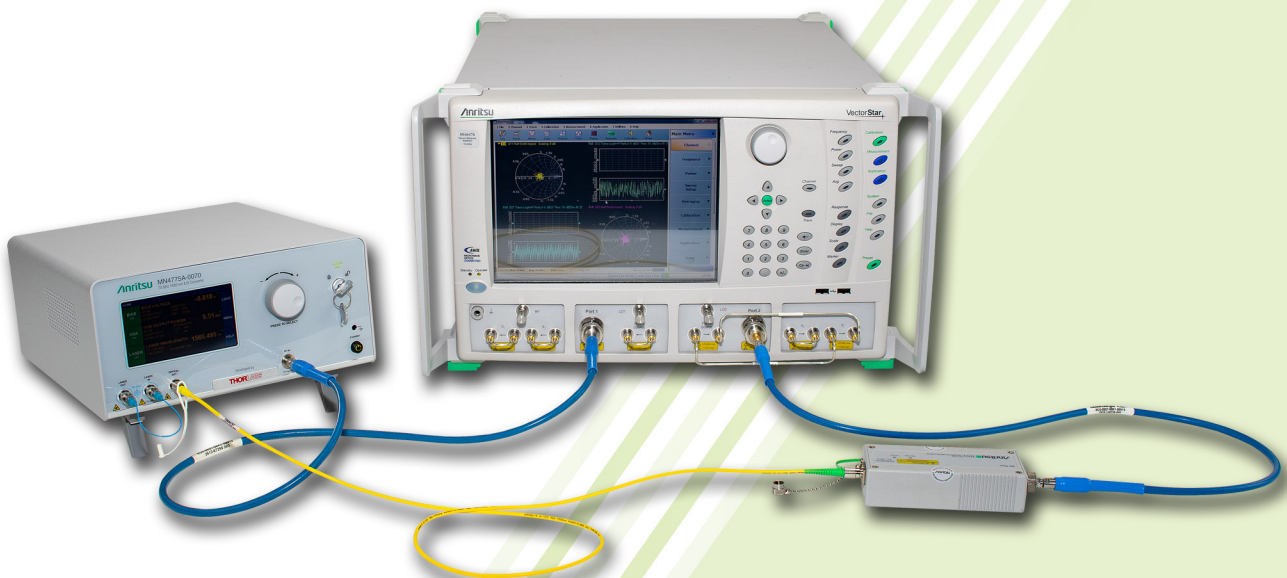

Introduction

The VectorStar™ Opto-electronic Network Analyzer (ONA) ME7848A/E-02xx system includes the VectorStar VNA combined with a traceable O/E Calibration Module and an E/O converter. The ME7848A/E ONA with the E/O converter and O/E calibration module enables the measurement of domain-transfer devices such as optical modulators, modulated lasers, optical transmitters, photodiodes, photo-receivers and transceivers. The ONA system facilitates the measurement of electrical to optical (E/O) and optical to electrical (O/E) transfer function in terms of bandwidth, flatness, and phase linearity (group delay). The ME7848A/E-01xx systems have all of the potential functionality of the -02xx systems, but do not include an E/O converter.

Various system options provide the ability to measure optical devices at the 850, 1310, 1550, or 1310/1550 nm wavelengths. System modularity offers the ability to add detectors and/or converters with different wavelengths to expand system capabilities without the need for additional VNAs.

Key Features and Benefits

- Fast and accurate optoelectronic measurements—The VectorStar ME7848A/E-0200 series ONA, when calibrated using the MN4765B O/E Calibration Module, enables error-corrected Transfer Function, Group Delay, and Return Loss measurements of E/O and O/E components and subsystems.
- MN4765B O/E Calibration Module—The O/E calibration module is a photodiode reference standard detector that is thermally stabilized to minimize drift over temperature.
- MN4775A E/O Converter—The E/O converter includes a lithium niobate (LiNbO3) modulator stabilized by a fully automatic bias controller and a tunable or fixed-wavelength laser source. Excellent converter stability ensures characteristics remain consistent during measurement of O/E DUT detectors and receivers.
- National Institute of Standards and Technology derived characterization—Magnitude and phase characterization of the O/E calibration module is obtained using a primary standard characterized by NIST and held in the Anritsu Calibration Lab.
- Internal Biasing—Accurate bias voltage to the photodiode is maintained internally.
- Internal VNA de-embedding for simplified calibration—The built-in application menus provide instructions that guide the user through the set-up and the calibrations required for making E/O and O/E measurements.
- Excellent stability and repeatability—The use of full 12-term calibration with de-embedding results in stable and repeatable measurements of optoelectronic devices using the VectorStar VNA.
- Modularity and Upgradeability—The ME7848A/E ONA can be easily modified to a different wavelength by adding the appropriate MN4775A E/O converter and MN4765B O/E Calibration Module. The ME7848A/E-100 series can be upgraded to a 200 series by including the appropriate MN4775A E/O converter. In contrast to turn-key solutions, since the same model VectorStar VNA can be used at multiple wavelengths, purchasing additional VNAs is not necessary.
- Measurement flexibility—The VectorStar VNA can be easily switched between electrical and opto-electronic measurements. Only one 12-term calibration is required, which can be applied to E/E, E/O, and O/E set-ups.

System Components

- MS464XB VNA with option 051 (access loops; options 061 or 062 may be chosen as options) or ME7838AX/EX Broadband VNA system (the ME7848E systems are only available for the 110 GHz case and include the ME7838EX broadband VNA)
- MN4765B-XXXX O/E Calibration Module
- MN4775A-0040/0070/0071/0072/0110/0111 E/O Converter (-02XX systems only)
- 1 m single mode patch cord (FC/PC-FC/APC)
- Two 1 m RF cables (13cm W(1 mm) cables for the -021x systems)
- Fiber connector cleaning kit
- Two semi-rigid cables to support the reversed coupler configuration (Not included for 110 GHz systems.)

MN4765B O/E Calibration Module

- The MN4765B is the base calibration module and when combined with appropriate options can be used with the Anritsu VNAs to perform accurate, flexible and cost-effective characterization of opto-electronic devices. Option 40 offers opto-electronic measurements of devices from 70 kHz to 40 GHz in the 850 nm range. The 1550 and 1310 nm wavelengths are supported with the Option 70/110 and 71/111 respectively, (option 72/112 supports both 1310 and 1550 nm). These O/E Calibration Modules consist of an InGaAs photodiode that converts modulated optical signals to electrical signals and includes additional circuitry for temperature and bias stability.
- The built-in de-embedding software provides full on- screen direction, thus, simplifying calibration and speeding measurement throughput. With the VectorStar VNA's proven stability, the technique provides unparalleled measurement repeatability and offers a cost- effective application solution for optoelectronic device characterization.

MN4775A E/O Converter

- The MN4775A E/O converters offer wavelength support of 850 nm at 40 GHz and 1310 and 1550 nm with frequency response to 70 GHz or 110 GHz. Each converter incorporates a telecommunication grade lithium niobate (LiNbO3) modulator that is stabilized by an automatic bias controller (all specifications assume this bias controller is in quadrature mode). The converter also includes a tunable or fixed-wavelength laser source. The 1310 and 1550 nm versions also have loopback access for operation using an external laser.

Table of Contents

Definitions 4

Basic Specifications 5

RF Power-Related Specifications 7

Power Range 7

E/O Measurements 9

O/E Measurements 19

O/O Measurements 29

Example Plots 36

Standard Capabilities 38

Remote Operability 40

Calibration and Correction Capabilities 41

Optional Capabilities 42

CPU, OS, Memory, and Security Features 48

Front Panel Connections of VNA 49

Rear Panel Connections of VNA 50

Mechanical and Environmental 52

Regulatory Compliance 52

MN4765B O/E Calibration Module 53

MN4775A E/O Converter Features 55

Ordering Information 57

Optoelectronic Measurement System Options 60

3743AX/EX mmWave Module 60

36585-Series Automatic Calibrators (AutoCal) 61

Mechanical Calibration Kits 62

Test Port Cables 67

Documentation 69

Extended Service 69

Definitions

Min. measurable frequency response	The measured responsivity when no modulating signal is present and this represents the noise floor of the VNA plus one side of the O/E to E/O conversion system. This can be expressed in dBm terms or in responsivity terms.
Normal and reversed	Some of the parameters have different values depending on the coupler configuration of the VNA. 'Normal' refers to the as-shipped condition where all of the access loops are intact. 'Reversed' refers to the replacement/swapping of access loops (using the semi-rigid cables in the accessory kit) for port 2. This increases the dynamic range in most bands for S21 at the expense of that for S12. The reversed configuration does not apply to 110 GHz systems, as loop access is not available for the entire frequency range.
Relative freq. response uncertainty	The uncertainty in the shape of the transmission response as a function of frequency and delivered signal and does not take into account absolute responsivities or optical power (except in the sense of affecting delivered signal).
Absolute freq. response uncertainty	Like the above but now in terms of responsivity so the other responsivity terms in the system and the optical power levels directly impact the result.
Frequency response repeatability (trace noise):	The variation on the transmission response over short periods of time due to noise. This is a function of drive level, optical power, IF bandwidth and other setup details.

Specifications (and related definitions) and stated values are based on certain conditions:

Option 61/62	Some specification tables specifically call out VNA option 62 (loops and four step attenuators). Option 61 (loops and two step attenuators) will have the same values here as option 62.
Warm-up time	After 90 minutes of warm-up time, where the instruments are left in their ON state.
Temperature range	Over the 25 °C ± 5 °C temperature range
Error-corrected specifications	For error-corrected specifications, over 23 °C ± 3 °C with < 1 °C variation from calibration temperature
User cables/adapters	Specifications and typical values do not include effects of any user cables, adapters, fixtures or other structures attached to the instrument unless noted.
Discrete spurious responses	Specifications may exclude discrete spurious responses.
Internal reference source	All specifications apply when the internal 10 MHz reference is used.
Interpolation mode	All specifications are with interpolation mode OFF.
Typical performance	'Typical' specifications describe expected, but not warranted, performance based on analysis of a statistically significant set of samples. Typical performance indicates measured performance of an average unit and does not guarantee the performance of an individual unit and is shown in parentheses (e.g., (-102 dB)) or noted as Typical.
Characteristic performance	Characteristic performance indicates a level of performance that is designed-in and verified during the design phase. These values are not covered by the product warranty.
Below 300 kHz	All uncertainties below 300 kHz are typical.
Other information	Recommended calibration cycle 12 months on components (or system as a whole for -02xx cases). Uncertainties are dependent on calibration kit residual performance, so the calibration kit calibration cycle should be adhered to as well.
Specifications subject to change	All specifications are subject to change without notice. For the most current data sheet, please visit the Anritsu web site at www.anritsu.com

A detailed color brochure available on the Anritsu web site provides descriptions and examples of the VectorStar™ family's features and benefits. The web site also provides detailed information on 110/125/145/220 GHz Broadband Coaxial, Banded Waveguide, and Multiport solutions based on the MS4640B VNA:
<https://www.anritsu.com/test-measurement/products/ms4640b-series>

A detailed color brochure available on the Anritsu web site provides descriptions and examples of the ME7848A/E's features and benefits. The web site also provides documentation under the Library tab:
<https://www.anritsu.com/test-measurement/products/me7848a>

The instrument may be protected by one or more of the following patents: 6894581, 7088111, 7545151, 7683633, 7924024, 8185078, 8306134, 8417189, 8718586, 9103873, 9606212, 9753071, 10225073, 10778592, 10225073 depending on the model and option configuration of the instrument.

Basic Specifications¹

	ME7848A-0240	ME7848A/E-0210	ME7848A/E-0211
RF frequency range^a	70 kHz-40 GHz	70 kHz-110 GHz	70 kHz-110 GHz
RF connector type	K (2.92 mm)	W (1 mm)	W (1 mm)
Optical source input connector type (polarization-maintaining fiber recommended)	FC/PC	FC/PC	FC/PC
Optical output and modulated input connector type	FC/APC	FC/APC	FC/APC
Receiver wavelength range	800 - 1700 nm	1480 - 1620 nm	1300 - 1330 nm
Receiver DC responsivity	> 0.2 A/W (850 ± 20 nm)	> 0.5 A/W (1550 ± 20 nm)	> 0.25 A/W (1319 ± 10nm) ^b
Maximum linear optical power to receiver (< 0.5 dB variance in frequency response shape)	2 dBm	6 dBm	6 dBm
Maximum safe optical power (average) to receiver	6 dBm	10 dBm	10 dBm
Optical return loss (modulation output and detection ports)	>24 dB	>24 dB	>24 dB
Average optical power uncertainty (transmit)	± 0.5 dB	± 0.5 dB	± 0.5 dB
Optical modulation sensitivity (RF V_π at 1 GHz, typical)	2.3 V pk-pk	3.3 V pk-pk	3.3 V pk-pk
Transmit wavelength	850 nm	1527-1565 nm	1310 nm
Average output power range (typical)	-17 to -1 ^c dBm	-15 to +3 dBm	-15 to +3 dBm
Output power stability (over 4 hours and 3 °C temperature range)	± 0.1 dB	± 0.1 dB	± 0.1 dB
Optical Modulation path loss (quadrature bias, typical)	8 dB	14 dB	14 dB
0.1 dB compression point of RF receiver (at port)^a (characteristic)	> +5 dBm for 70 kHz to 300 kHz > +11 dBm above 300 kHz	> +5 dBm for 70 kHz to 300 kHz > +10 dBm above 300 kHz	> +5 dBm for 70 kHz to 300 kHz > +10 dBm above 300 kHz
0.1 dB compression point of RF receiver (at reversed port)^a (characteristic)	> -15 dBm 70 kHz to 300 kHz > -10 dBm 300kHz to 2.5 GHz > -5 dBm above 2.5 GHz	N/A	N/A
Modulation port return loss (raw)^a	> 10 dB for < 20 GHz > 7.5 dB for 20 to 40 GHz	> 10 dB for < 70 GHz ^b > 6 dB for 70 to 110 GHz ^b	> 10 dB for < 70 GHz ^b > 6 dB for 70 to 110 GHz ^b
Detection port return loss (raw)^a	> 10 dB for < 18 GHz > 3dB for 18 to 40 GHz	> 8 dB for < 50 GHz ^b > 4 dB for 50 to 110 GHz ^b	> 8 dB for < 50 GHz ^b > 4 dB for 50 to 110 GHz ^b

a. These line entries assume the presence of VNA Option 70 (70 kHz lower frequency limit). Without Option 70, the minimum frequency is 10 MHz.

b. Typical.

c. Recommended operation at -3 dBm and below for optimal modulator performance.

1. All system specifications are based on the modulator being biased in quadrature mode.

	ME7848A-0270	ME7848A-0271	ME7848A-0272
RF frequency range^a	70 kHz-70 GHz	70 kHz-70 GHz	70 kHz-70 GHz
RF connector type	V (1.85 mm)	V (1.85 mm)	V (1.85 mm)
Optical source input connector type (polarization-maintaining fiber recommended)	FC/PC	FC/PC	FC/PC
Optical output and modulated input connector type	FC/APC	FC/APC	FC/APC
Receiver wavelength range	1480 - 1620 nm	1300 - 1330 nm	1300 - 1330 nm and 1480 - 1620 nm
Receiver DC responsivity	> 0.7 A/W (1550 ± 20 nm)	> 0.45 A/W (1319 ± 10nm)	> 0.45 A/W (1319 ± 10nm) > 0.65 A/W (1550 nm ± 20 nm)
Maximum linear optical power to receiver (< 0.5 dB variance in frequency response shape)	6 dBm	6 dBm	6 dBm
Maximum safe optical power (average) to receiver	10 dBm	10 dBm	10 dBm
Optical return loss (modulation output and detection ports)	>24 dB	>24 dB	>24 dB
Average optical power uncertainty (transmit)	± 0.5 dB	± 0.5 dB	± 0.5 dB
Optical modulation sensitivity (RF V_{π} at 1 GHz, typical)	5.5V pk-pk	5.5V pk-pk	5.5V pk-pk
Transmit wavelength	1527-1565 nm	1310 nm	1310 nm or 1527-1565 nm
Average output power range (typical)	-15 to +5 dBm	-17 to +2 dBm	-20 to +4 dBm
Output power stability (over 4 hours and 3 °C temperature range)	± 0.1 dB	± 0.1 dB	± 0.1 dB
Optical Modulation path loss (quadrature bias, typical)	8 dB	10 dB	10 dB
0.1 dB compression point of RF receiver (at port)^a (characteristic)	> +5 dBm for 70 kHz to 300 kHz > +11 dBm above 300 kHz	> +5 dBm for 70 kHz to 300 kHz > +11 dBm above 300 kHz	> +5 dBm for 70 kHz to 300 kHz > +11 dBm above 300 kHz
0.1 dB compression point of RF receiver (at reversed port)^a (characteristic)	> -15 dBm 70 kHz to 300 kHz > -10 dBm 300kHz to 2.5 GHz > -5 dBm above 2.5 GHz	> -15 dBm 70 kHz to 300 kHz > -10 dBm 300kHz to 2.5 GHz > -5 dBm above 2.5 GHz	> -15 dBm 70 kHz to 300 kHz > -10 dBm 300kHz to 2.5 GHz > -5 dBm above 2.5 GHz
Modulation port return loss (raw)^a	> 10 dB for < 20 GHz > 7.5 dB for 20 to < 50 GHz > 3 dB for 50 to 70 GHz	> 10 dB for < 20 GHz > 7.5 dB for 20 to < 50 GHz > 3 dB for 50 to 70 GHz	> 10 dB for < 20 GHz > 7.5 dB for 20 to < 50 GHz > 3 dB for 50 to 70 GHz
Detection port return loss (raw)^a	> 8 dB for < 50 GHz > 5 dB for 50 to 70 GHz	> 8 dB for < 50 GHz > 5 dB for 50 to 70 GHz	> 8 dB for < 50 GHz > 5 dB for 50 to 70 GHz

a. These line entries assume the presence of VNA Option 70 (70 kHz lower frequency limit). Without Option 70, the minimum frequency is 10 MHz.

RF Power-Related Specifications

The RF power from the VNA will affect dynamic range and minimum measurable response specifications and may be important for certain DUTs in terms of linearity. The RF power specifications are derived from the basic VNA and the tables below come directly from the **MS464XB Technical Data Sheet** and are referenced to the VNA ports. For more details on other basic VNA specifications, consult the basic VNA Technical Data Sheet.

Power Range

Maximum rated power to minimum level. The difference reflects the ALC range for models Option 51, and the ALC plus attenuator range for models with Option 61 or 62. Maximum Rated Power is typical from 2.4 GHz to 2.7 GHz.

MS4644B, 40 GHz Model, Power Range (dBm)

Frequency (GHz)	Option 51	Option 61 ^a or 62
70 kHz to 0.01^b	+9 to -25	+8 to -95
> 0.01 to < 2.5	+11 to -25	+10 to -95
2.5 to 20	+8 to -20	+7 to -90
> 20 to 40	+8 to -25	+7 to -95
With Option 31^c		
70 kHz to 0.01	+11 to -25	+10 to -95
> 0.01 to < 2.5	+13 to -25	+12 to -95
2.5 to 20	+11 to -20	+10 to -90
> 20 to 40	+11 to -25	+10 to -95

a. The Option 61 power range reported in this column applies to Port 1. For Port 2, use the figures from the Option 51 column.

b. Without Option 70, the lower frequency limit is 10 MHz.

c. With Option 8x, est Port 2 maximum power is equivalent to the non-Option 031 range (typical).

MS4647B, 70 GHz Model, Power Range (dBm)

Frequency (GHz)	Option 51	Option 61 ^a or 62
70 kHz to 0.01^b	+9 to -25	+8 to -85
> 0.01 to < 2.5	+11 to -25	+10 to -85
2.5 to 5	+5 to -20	+3 to -80
> 5 to 20	+4 to -20	+2 to -80
> 20 to 38	+4 to -25	+2 to -85
> 38 to 50^c	+3 to -25	+1 to -85
> 50 to 65	-2 to -25	-4 to -85
> 65 to 67	-3 to -25	-5 to -85
> 67 to 70	-6 to -25	-10 to -85
With Option 31^d		
70 kHz to 0.01^b	+11 to -25	+10 to -85
> 0.01 to < 2.5	+13 to -25	+12 to -85
2.5 to 5	+7 to -20	+5 to -80
> 5 to 20	+7 to -20	+5 to -80
> 20 to 38	+6 to -25	+4 to -85
> 38 to 50	+5 to -25	+3 to -85
> 50 to 65	+5 to -25	+3 to -85
> 65 to 67	+4 to -25	+2 to -85
> 67 to 70	+1 to -25	-3 to -85

a. The Option 61 power range reported in this column applies to Port 1. For Port 2, use the figures from the Option 51 column.

b. Without Option 70, the lower frequency limit is 10 MHz.

c. Rated power is typical between 49 GHz to 50 GHz.

d. With Option 8x, Test Port 2 maximum power is equivalent to the non-Option 31 range (typical). 38 to 50 GHz range may degrade by up to 3 dB.

ME7838AX/EX Power Range (dBm)

Values shown are without option 31 (dual source). Several dB of additional power is available for frequencies below 54 GHz with option 31.

ME7838AX/EX Specifications [dB]			
Frequency Range	No Options	Option 51^a	Option 61 or 62
70 to 300 kHz	10 to -25	10 to -25	7 to -85
> 0.3 to 2 MHz	10 to -25	10 to -25	7 to -85
> 2 to 10 MHz	12 to -25	12 to -25	10 to -85
> 0.01 to < 2.5 GHz	10 to -25	9 to -25	8 to -85
2.5 to 10 GHz	4 to -25	3 to -25	2 to -85
> 10 to 24 GHz	-1 to -25	-2 to -25	-2 to -85
> 24 to 40 GHz	-2 to -30	-4 to -30	-4 to -90
> 40 to 54 GHz	-7 to -30	-10 to -30	-11 to -90
> 54 to 60 GHz	-2 to -55	-2 to -55	-2 to -55
> 60 to 65 GHz	-2 to -55	-2 to -55	-2 to -55
> 65 to 70 GHz	-6 to -55	-6 to -55	-6 to -55
> 70 to 80 GHz	-4.5 to -55	-4.5 to -55	-4.5 to -55
> 80 to 90 GHz	-6.5 to -55	-6.5 to -55	-6.5 to -55
> 90 to 100 GHz	-2.5 to -55	-2.5 to -55	-2.5 to -55
> 100 to 110 GHz	-6.5 to -55	-6.5 to -55	-6.5 to -55
> 110 to 115 GHz	-7 to -50	-7 to -50	-7 to -50
> 115 to 120 GHz^b	-3 to -40	-3 to -40	-3 to -40
> 120 to 125 GHz^b	-3 to -40	-3 to -40	-3 to -40

a. Also ME7838AX/EX Option 61, S12 values.

b. ME7838AX only.

E/O Measurements

Noise Floor for E/O Measurements

Expressed in terms of dBm (RMS) in a 10 Hz IFBW (average values are typically 4-6 dB lower (more negative)). Based on maximum nominal optical power from modulator (+5 dBm (-0270), +2 dBm (-0271), +4 dBm (-0272, -3 dBm (-0240), or +3 dBm (-021x)) and derived from de-embedding the absolute O/E response. Interconnecting fiber loss (1 m) neglected. 1 m VNA cable loss (between the instrument test ports) is included for the 40 and 70 GHz systems. 'Normal' refers to the conventional VNA coupler configuration. 'Reversed' refers to the use of the loop access to reverse the orientation of the port 2 test couplers (requires changing front and rear panel access loop configuration (this does not apply to 110 GHz systems)). The table below assumes the presence of VNA Option 70 (70 kHz operation); otherwise the minimum frequency is 10 MHz. For Option -0240 systems measuring E/O devices with multimode outputs, the effective noise floors will be about 20 dB higher due to interconnect losses.

Frequency (GHz)	ME7848A-0240 (dBm)				ME7848A-0271 ^a (dBm)				ME7848A-0270 ^a (dBm)			
	051 Normal	051 Reversed	062 Normal	062 Reversed	051 Normal	051 Reversed	062 Normal	062 Reversed	051 Normal	051 Reversed	062 Normal	062 Reversed
70 kHz to 300 kHz	-54	-64	-54	-64	-73	-83	-73	-83	-81	-91	-81	-91
> 300 kHz to 2 MHz	-59	-69	-59	-69	-78	-88	-78	-88	-86	-96	-86	-96
> 2 MHz to 10 MHz	-64	-74	-64	-74	-83	-93	-83	-93	-91	-101	-91	-101
> 0.01 to < 2.5	-72	-79	-72	-79	-93	-100	-93	-100	-101	-107	-101	-107
2.5 to 5	-74	-81	-74	-81	-93	-100	-93	-100	-101	-108	-101	-108
> 5 to 20	-71	-78	-71	-78	-89	-96	-89	-96	-97	-104	-97	-104
> 20 to 38/40 ^b	-68	-70	-68	-69	-87	-89	-86	-88	-95	-97	-94	-96
> 38 to 50	-	-	-	-	-81	-83	-80	-81	-89	-90	-88	-89
> 50 to 65	-	-	-	-	-79	-77	-77	-75	-87	-85	-85	-83
> 65 to 67	-	-	-	-	-77	-74	-74	-71	-85	-82	-82	-79
> 67 to 70	-	-	-	-	-72	-69	-68	-65	-80	-77	-76	-73

a. For Option -0272, use the -0271 values for 1310 nm operation. Use the Option -0270 values for 1550 nm operation but add 2 dB.

b. 38 GHz applies for Option -027x systems; 40 GHz applies for the Option -0240 system.

Frequency (GHz)	ME7848A/E-0210 (dBm)			ME7848A/E-0211 ^a (dBm)		
	000 Normal	051 Normal	062 Normal	000 Normal	051 Normal	062 Normal
70 kHz to 300 kHz	-75	-75	-75	-71	-71	-71
> 300 kHz to 2 MHz	-87	-87	-87	-83	-83	-83
> 2 MHz to 10 MHz	-101	-101	-101	-97	-97	-97
> 0.01 to < 2.5	-99	-99	-99	-95	-95	-95
2.5 to 10	-103	-102	-101	-99	-98	-97
> 10 to 24	-99	-97	-97	-95	-93	-93
> 24 to 40	-98	-97	-96	-94	-93	-92
> 40 to 54	-102	-101	-99	-98	-97	-95
> 54 to 60	-100	-100	-100	-96	-96	-96
> 60 to 65	-100	-100	-100	-96	-96	-96
> 65 to 70	-99	-99	-99	-95	-95	-95
> 70 to 80	-97	-97	-97	-93	-93	-93
> 80 to 90	-97	-97	-97	-93	-93	-93
> 90 to 100	-92	-92	-92	-88	-88	-88
> 100 to 110	-93	-93	-93	-89	-89	-89

a. Typical.

Expressed in terms of measurable optical response dB (W/A) (defined as the equivalent modulated optical power per unit RF current) at +5 dBm optical (-0270), +2 dBm optical (-0271), +4 dBm optical (-0272), -3 dBm optical (-0240), or +3 dBm optical (-021x maximum nominal). This is an RMS noise floor definition in a 10 Hz IFBW and is derived from de-embedding the absolute O/E response (average values are typically 4-6 dB lower (more negative)). Interconnecting fiber loss (1 m) is neglected. 1 m VNA cable loss (between the instrument test ports) is included for 40 and 70 GHz systems. The value is based on -10 dBm VNA port power for the -027x/-021x models and +5 dBm VNA port power for the Option -0240 model (default power for 70 GHz and 40 GHz VNAs, respectively). 'Normal' refers to the conventional VNA coupler configuration. 'Reversed' refers to the use of the loop access to reverse the orientation of the port 2 test coupler (does not apply to 110 GHz systems). The table below assumes the presence of VNA Option 70 (70 kHz operation); otherwise the minimum frequency is 10 MHz.

Frequency (GHz)	ME7848A-0240 (dB (W/A))				ME7848A-0271 ^a (dB (W/A))				ME7848A-0270 ^a (dB (W/A))			
	051 Normal	051 Reversed	062 Normal	062 Reversed	051 Normal	051 Reversed	062 Normal	062 Reversed	051 Normal	051 Reversed	062 Normal	062 Reversed
70 kHz to 300 kHz	-43	-53	-43	-54	-68	-78	-68	-78	-76	-86	-76	-86
> 300 kHz to 2 MHz	-48	-58	-48	-58	-73	-83	-73	-83	-81	-91	-81	-91
> 2 MHz to 10 MHz	-53	-63	-53	-63	-78	-88	-78	-88	-86	-96	-86	-96
> 0.01 to < 2.5	-61	-68	-61	-68	-88	-95	-88	-95	-96	-102	-96	-102
2.5 to 5	-63	-70	-63	-70	-88	-95	-88	-95	-96	-103	-96	-103
> 5 to 20	-59	-66	-59	-66	-84	-91	-84	-91	-92	-99	-92	-99
> 20 to 38/40 ^b	-57	-59	-57	-58	-82	-84	-81	-84	-90	-92	-89	-91
> 38 to 50	-	-	-	-	-76	-78	-75	-76	-84	-85	-83	-84
> 50 to 65	-	-	-	-	-74	-72	-72	-70	-82	-80	-80	-78
> 65 to 67	-	-	-	-	-72	-69	-69	-66	-80	-77	-77	-74
> 67 to 70	-	-	-	-	-67	-64	-63	-60	-75	-72	-71	-68

a. For Option -0272, use the Option -0271 values for 1310 nm operation. Use the Option -0270 values for 1550 nm operation, but add 2 dB.

b. 38 GHz applies for Option -027x systems; 40 GHz applies for the Option -0240 system.

Frequency (GHz)	ME7848A/E-0210 (dB (W/A))			ME7848A/E-0211 ^a (dB (W/A))		
	000 Normal	051 Normal	062 Normal	000 Normal	051 Normal	062 Normal
70 kHz to 300 kHz	-71	-71	-71	-68	-68	-68
> 300 kHz to 2 MHz	-83	-83	-83	-80	-80	-80
> 2 MHz to 10 MHz	-97	-97	-97	-94	-94	-94
> 0.01 to < 2.5	-95	-95	-95	-92	-92	-92
2.5 to 10	-99	-98	-97	-96	-95	-94
> 10 to 24	-95	-93	-93	-92	-90	-90
> 24 to 40	-94	-93	-92	-91	-90	-89
> 40 to 54	-98	-97	-95	-95	-94	-92
> 54 to 60	-96	-96	-96	-93	-93	-93
> 60 to 65	-96	-96	-96	-93	-93	-93
> 65 to 70	-95	-95	-95	-92	-92	-92
> 70 to 80	-93	-93	-93	-90	-90	-90
> 80 to 90	-93	-93	-93	-90	-90	-90
> 90 to 100	-88	-88	-88	-85	-85	-85
> 100 to 110	-90	-90	-90	-87	-87	-87

a. Typical.

Frequency Response Repeatability for E/O Measurements

Typical and in dB terms, 10 Hz IFBW at various composite response levels (P1-P4) at the receiving VNA port (assumed normal (not reversed)), excludes fiber connector effects. The composite response is affected by the optical power level and the E/O responsivity. Assumes nominal 90 minute warm-up time and ignores DUT bias system stability effects. The corresponding low frequency E/O $V_{\pi,rf}$ values below are based on default RF power, +5dBm optical power (-0270), +2 dBm optical power (-0271), +4 dBm optical (-0272), -3 dBm optical power (-0240), or +3 dBm optical (-021x), and Anritsu O/E module specified low frequency responsivities. At higher frequencies, values scale with the roll-off. The table below assumes the presence of VNA Option 70 (70 kHz operation); otherwise the minimum frequency is 10 MHz.

- P1 received level -30 dBm (at low freq, $V_{\pi,rf}$ of 0.6 V, 0.4 V, or 1.1 V for -0240, -0271/2, or -0270, respectively)
- P2 received level -40 dBm (at low freq, $V_{\pi,rf}$ of 1.8 V, 1.1 V, or 3.5 V for -0240, -0271/2, or -0270, respectively)
- P3 received level -50 dBm (at low freq, $V_{\pi,rf}$ of 6 V, 3.6 V, or 11 V for -0240, -0271/2, or -0270, respectively)
- P4 received level -60 dBm (at low freq, $V_{\pi,rf}$ of 18 V, 11 V, or 35 V for -0240, -0271/2, or -0270, respectively)

Frequency (GHz)	ME7848A-0240 (dB)				ME7848A-0271 ^a (dB)				ME7848A-0270 ^a (dB)			
	P1	P2	P3	P4	P1	P2	P3	P4	P1	P2	P3	P4
70 kHz to 300 kHz	± 0.07	± 0.1	± 0.15	± 0.2	± 0.07	± 0.1	± 0.15	± 0.2	± 0.07	± 0.1	± 0.15	± 0.2
> 300 kHz to 2 MHz	± 0.05	± 0.07	± 0.1	± 0.15	± 0.05	± 0.07	± 0.1	± 0.15	± 0.05	± 0.07	± 0.1	± 0.15
> 2 MHz to 10 MHz	± 0.05	± 0.05	± 0.05	± 0.07	± 0.05	± 0.05	± 0.05	± 0.05	± 0.03	± 0.03	± 0.03	± 0.03
> 0.01 to < 2.5	± 0.05	± 0.05	± 0.05	± 0.07	± 0.05	± 0.05	± 0.05	± 0.05	± 0.03	± 0.03	± 0.03	± 0.03
2.5 to 5	± 0.03	± 0.05	± 0.05	± 0.05	± 0.05	± 0.05	± 0.05	± 0.05	± 0.03	± 0.03	± 0.03	± 0.03
> 5 to 20	± 0.03	± 0.05	± 0.05	± 0.05	± 0.05	± 0.05	± 0.05	± 0.05	± 0.03	± 0.03	± 0.03	± 0.03
> 20 to 38/40 ^b	± 0.05	± 0.07	± 0.07	± 0.09	± 0.05	± 0.05	± 0.05	± 0.05	± 0.03	± 0.05	± 0.05	± 0.05
> 38 to 50	-	-	-	-	± 0.05	± 0.05	± 0.05	± 0.05	± 0.03	± 0.05	± 0.05	± 0.05
> 50 to 65	-	-	-	-	± 0.05	± 0.05	± 0.05	± 0.05	± 0.05	± 0.05	± 0.05	± 0.05
> 65 to 67	-	-	-	-	± 0.05	± 0.05	± 0.05	± 0.07	± 0.05	± 0.05	± 0.05	± 0.05
> 67 to 70	-	-	-	-	± 0.07	± 0.07	± 0.07	± 0.1	± 0.07	± 0.07	± 0.07	± 0.07

- a. For Option -0272, use the Option -0271 values for 1310 nm operation. Use the Option -0270 values for 1550 nm operation.
- b. 38 GHz applies for Option -027x systems; 40 GHz applies for the Option -0240 system.

- P1 received level -30 dBm (at low freq, $V_{\pi,rf}$ of 0.5 V pk for 110 GHz systems)
- P2 received level -40 dBm (at low freq, $V_{\pi,rf}$ of 1.7 V pk for 110 GHz systems)
- P3 received level -50 dBm (at low freq, $V_{\pi,rf}$ of 5.2 V pk for 110 GHz systems)
- P4 received level -60 dBm (at low freq, $V_{\pi,rf}$ of 16.5 V pk for 110 GHz systems)

Frequency (GHz)	ME7848A/E-0210 (dB)				ME7848A/E-0211 (dB)			
	P1	P2	P3	P4	P1	P2	P3	P4
70 kHz to 300 kHz	± 0.07	± 0.10	± 0.15	± 0.20	± 0.10	± 0.15	± 0.20	± 0.25
> 300 kHz to 2 MHz	± 0.05	± 0.07	± 0.10	± 0.15	± 0.10	± 0.10	± 0.15	± 0.20
> 2 MHz to 10 MHz	± 0.03	± 0.03	± 0.03	± 0.03	± 0.07	± 0.07	± 0.07	± 0.07
> 0.01 to < 2.5	± 0.03	± 0.03	± 0.03	± 0.03	± 0.07	± 0.07	± 0.07	± 0.07
2.5 to 10	± 0.03	± 0.03	± 0.03	± 0.03	± 0.03	± 0.03	± 0.03	± 0.05
> 10 to 24	± 0.05	± 0.05	± 0.05	± 0.05	± 0.05	± 0.05	± 0.05	± 0.05
> 24 to 40	± 0.05	± 0.05	± 0.05	± 0.05	± 0.05	± 0.05	± 0.05	± 0.05
> 40 to 54	± 0.05	± 0.05	± 0.05	± 0.05	± 0.05	± 0.05	± 0.05	± 0.06
> 54 to 60	± 0.05	± 0.05	± 0.05	± 0.06	± 0.05	± 0.05	± 0.07	± 0.08
> 60 to 65	± 0.05	± 0.05	± 0.06	± 0.06	± 0.05	± 0.07	± 0.07	± 0.10
> 65 to 70	± 0.06	± 0.06	± 0.06	± 0.07	± 0.07	± 0.07	± 0.10	± 0.10
> 70 to 80	± 0.06	± 0.06	± 0.06	± 0.07	± 0.07	± 0.07	± 0.10	± 0.10
> 80 to 90	± 0.06	± 0.06	± 0.07	± 0.08	± 0.07	± 0.10	± 0.10	± 0.10
> 90 to 100	± 0.07	± 0.07	± 0.08	± 0.10	± 0.10	± 0.10	± 0.10	± 0.12
> 100 to 110	± 0.08	± 0.08	± 0.08	± 0.10	± 0.10	± 0.12	± 0.12	± 0.15

Frequency Response Uncertainty for E/O Measurements

Includes residual VNA calibration errors, electrical mismatch uncertainties, noise floor effects, characterization uncertainties, and repeatability. A full two-port calibration (using a 3654D calibration kit for the -027x systems, a 3652A calibration kit for the -0240 system, or a 3656C calibration kit for the -021x systems) is assumed and DUT mismatch is assumed to not be worse than -10 dB. 10 Hz IFBW is assumed and drive power is assumed low enough that linearity issues are not present. Uncertainties are on a 95% basis and are in single-sided dB terms and indexed to the power received by the VNA. All values are characteristic below 10 MHz. The corresponding low frequency E/O $V_{\pi,rf}$ values below are based on default RF power, +5 dBm optical power (-0270), +2 dBm optical power (-0271), +4 dBm optical power (-0272), -3 dBm optical power (-0240), or a 3656C calibration kit for the -021x systems), and Anritsu O/E module specified low frequency responsivities. At higher frequencies, values scale with the roll-off. The table below assumes the presence of VNA Option 70 (70 kHz operation); otherwise the minimum frequency is 10 MHz.

- P1 received level -30 dBm (at low freq, $V_{\pi,rf}$ of 0.6 V, 0.4 V, or 1.1 V for -0240, -0271/2, or -0270, respectively)
- P2 received level -40 dBm (at low freq, $V_{\pi,rf}$ of 1.8 V, 1.1 V, or 3.5 V for -0240, -0271/2, or -0270, respectively)
- P3 received level -50 dBm (at low freq, $V_{\pi,rf}$ of 6 V, 3.6 V, or 11 V for -0240, -0271/2, or -0270, respectively)
- P4 received level -60 dBm (at low freq, $V_{\pi,rf}$ of 18 V, 11 V, or 35 V for -0240, -0271/2, or -0270, respectively)

Frequency (GHz)	ME7848A-0240 (dB)				ME7848A-0271 ^a (dB)				ME7848A-0270 ^a (dB)			
	P1	P2	P3	P4	P1	P2	P3	P4	P1	P2	P3	P4
70 kHz to 300 kHz	± 1.1	± 1.1	± 1.3	± 2.3	± 0.7	± 0.8	± 1.1	± 2.2	± 0.6	± 0.7	± 1.0	± 2.2
> 300 kHz to 2 MHz	± 0.7	± 0.7	± 0.8	± 0.9	± 0.5	± 0.5	± 0.6	± 0.7	± 0.5	± 0.6	± 0.6	± 0.7
> 2 MHz to 10 MHz	± 0.6	± 0.6	± 0.6	± 0.6	± 0.3	± 0.3	± 0.3	± 0.3	± 0.3	± 0.3	± 0.3	± 0.3
> 0.01 to < 2.5	± 0.5	± 0.5	± 0.5	± 0.5	± 0.2	± 0.2	± 0.2	± 0.2	± 0.2	± 0.2	± 0.2	± 0.2
2.5 to 5	± 0.5	± 0.5	± 0.5	± 0.5	± 0.2	± 0.2	± 0.2	± 0.2	± 0.2	± 0.2	± 0.2	± 0.2
> 5 to 20	± 0.5	± 0.5	± 0.5	± 0.5	± 0.2	± 0.2	± 0.2	± 0.3	± 0.2	± 0.2	± 0.2	± 0.3
> 20 to 38/40 ^b	± 1.5	± 1.5	± 1.5	± 1.5	± 0.3	± 0.3	± 0.4	± 0.4	± 0.3	± 0.3	± 0.3	± 0.3
> 38 to 50	-	-	-	-	± 0.5	± 0.5	± 0.5	± 0.5	± 0.4	± 0.4	± 0.5	± 0.5
> 50 to 65	-	-	-	-	± 0.8	± 0.8	± 0.8	± 0.9	± 0.5	± 0.5	± 0.5	± 0.5
> 65 to 67	-	-	-	-	± 1.0	± 1.0	± 1.0	± 1.0	± 0.6	± 0.6	± 0.6	± 0.6
> 67 to 70	-	-	-	-	± 1.0	± 1.0	± 1.0	± 1.0	± 0.6	± 0.6	± 0.6	± 0.6

- a. For Option -0272, use the Option -0271 values for 1310 nm operation. Use the Option -0270 values for 1550 nm operation.
- b. 38 GHz applies for Option -027x systems; 40 GHz applies for the Option -0240 system.

- P1 received level -30 dBm (at low freq, $V_{\pi,rf}$ of 0.5 V pk for 110 GHz systems)
- P2 received level -40 dBm (at low freq, $V_{\pi,rf}$ of 1.7 V pk for 110 GHz systems)
- P3 received level -50 dBm (at low freq, $V_{\pi,rf}$ of 5.2 V pk for 110 GHz systems)
- P4 received level -60 dBm (at low freq, $V_{\pi,rf}$ of 16.5 V pk for 110 GHz systems)

Frequency (GHz)	ME7848A/E-0210 (dB)				ME7848A/E-0211 ^a (dB)			
	P1	P2	P3	P4	P1	P2	P3	P4
70 kHz to 300 kHz	± 0.6	± 0.7	± 1.0	± 2.2	± 0.6	± 0.7	± 1.0	± 2.2
> 300 kHz to 2 MHz	± 0.5	± 0.6	± 0.6	± 0.7	± 0.5	± 0.6	± 0.6	± 0.7
> 2 MHz to 10 MHz	± 0.5	± 0.5	± 0.5	± 0.5	± 0.5	± 0.5	± 0.5	± 0.5
> 0.01 to < 2.5	± 0.4	± 0.4	± 0.4	± 0.4	± 0.5	± 0.5	± 0.5	± 0.5
2.5 to 10	± 0.3	± 0.3	± 0.3	± 0.3	± 0.6	± 0.6	± 0.6	± 0.6
> 10 to 24	± 0.3	± 0.3	± 0.3	± 0.3	± 0.4	± 0.4	± 0.4	± 0.4
> 24 to 40	± 0.3	± 0.3	± 0.3	± 0.3	± 0.4	± 0.4	± 0.4	± 0.4
> 40 to 54	± 0.3	± 0.3	± 0.3	± 0.4	± 0.4	± 0.4	± 0.4	± 0.4
> 54 to 60	± 0.4	± 0.4	± 0.4	± 0.4	± 0.5	± 0.5	± 0.5	± 0.5
> 60 to 65	± 0.5	± 0.5	± 0.5	± 0.5	± 0.5	± 0.5	± 0.5	± 0.5
> 65 to 70	± 0.5	± 0.5	± 0.5	± 0.6	± 0.5	± 0.5	± 0.5	± 0.6
> 70 to 80	± 0.6	± 0.6	± 0.6	± 0.6	± 0.6	± 0.6	± 0.6	± 0.6
> 80 to 90	± 0.6	± 0.6	± 0.6	± 0.6	± 0.7	± 0.7	± 0.7	± 0.7
> 90 to 100	± 0.6	± 0.6	± 0.6	± 0.7	± 0.7	± 0.7	± 0.7	± 0.8
> 100 to 110	± 0.7	± 0.7	± 0.8	± 0.8	± 0.8	± 0.8	± 0.9	± 0.9

- a. Typical.

Curves showing the uncertainty relationships in more detail are below. The optical power and responsivity of the DUT (coupled with the responsivity of the MN4765B O/E Calibration Module) and any RF networks in the setup (e.g., cables and probes) will determine the x-axis value. For -0240 systems measuring a DUT with multimode outputs, the curves themselves do not change since the x-axes are based on detector output. For a given DUT optical output power and responsivity, the detector output levels will be about 20 dB lower than for an equivalent single-mode DUT due to the added optical interconnect loss.

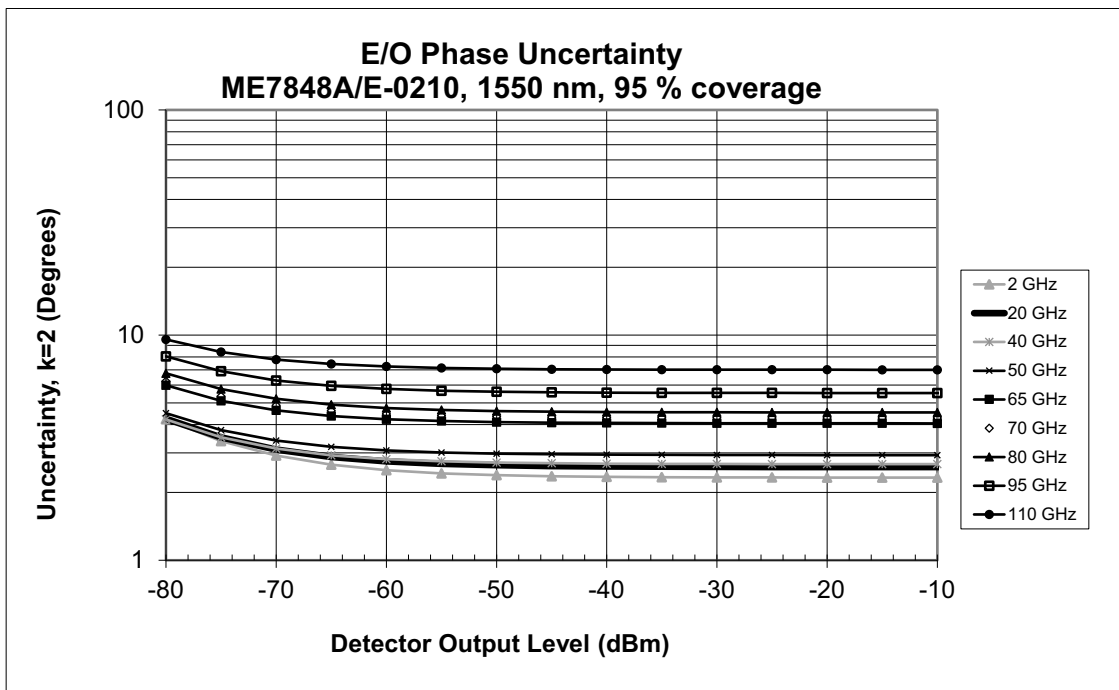
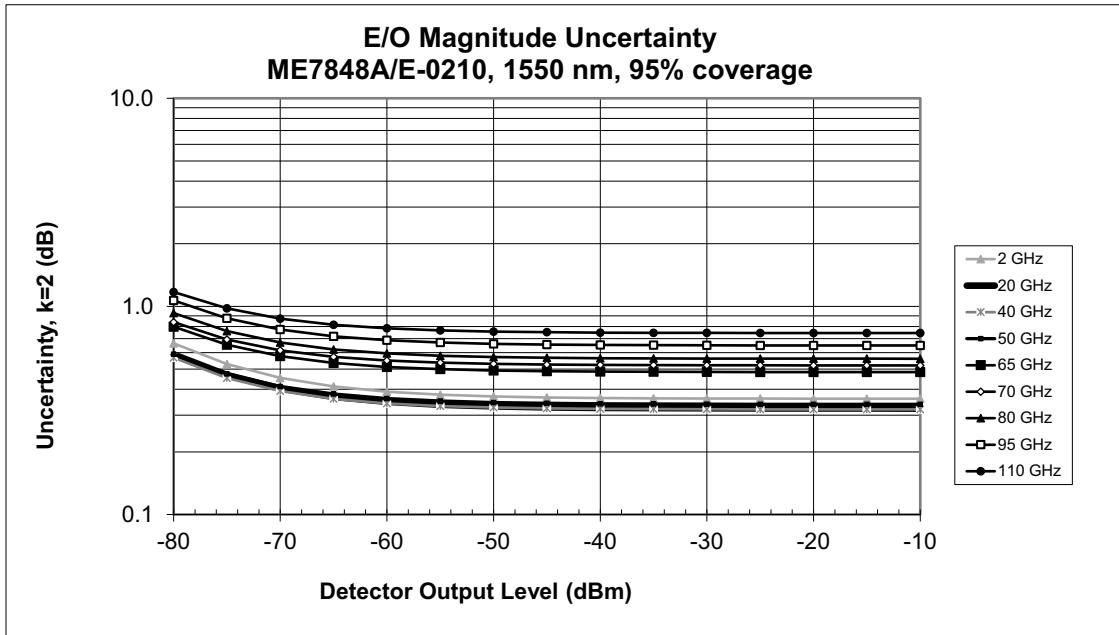

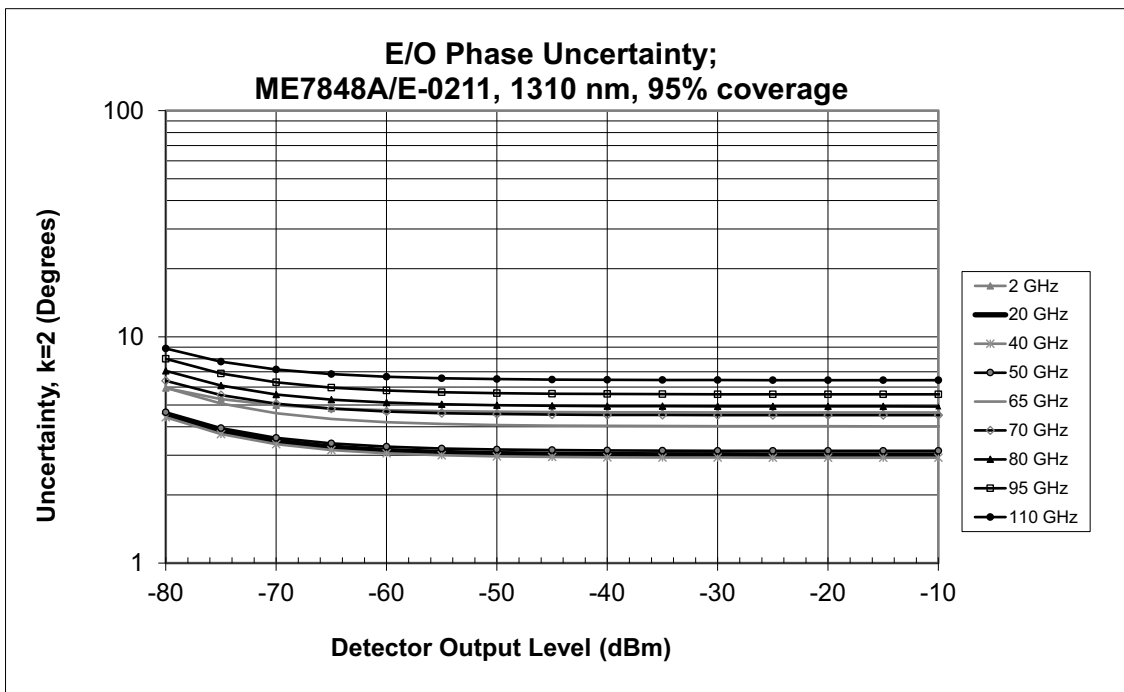
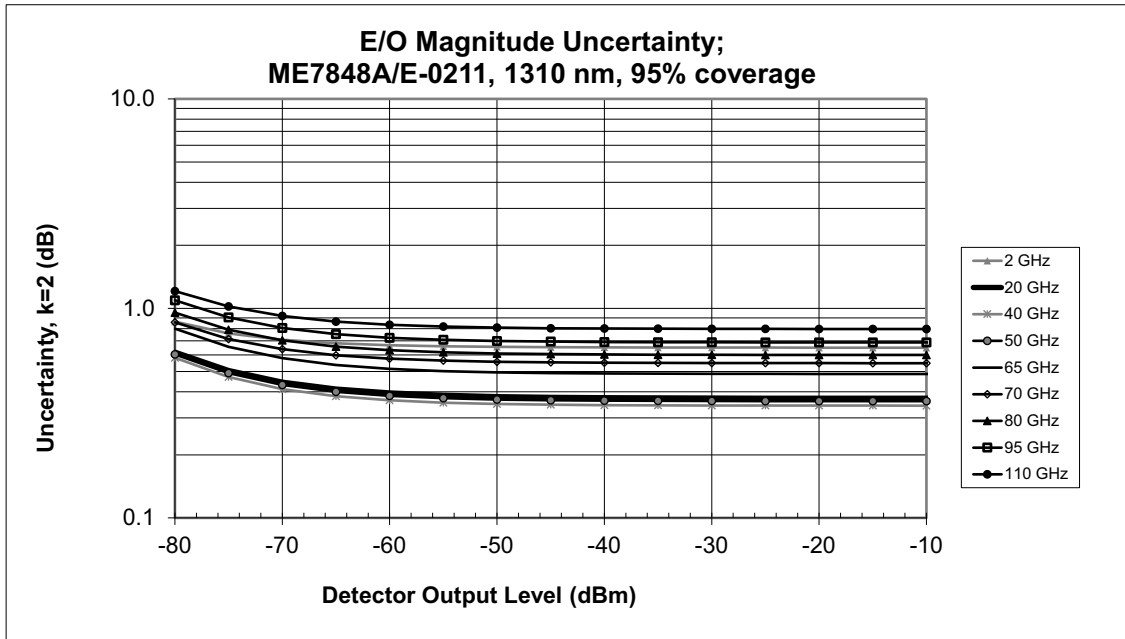

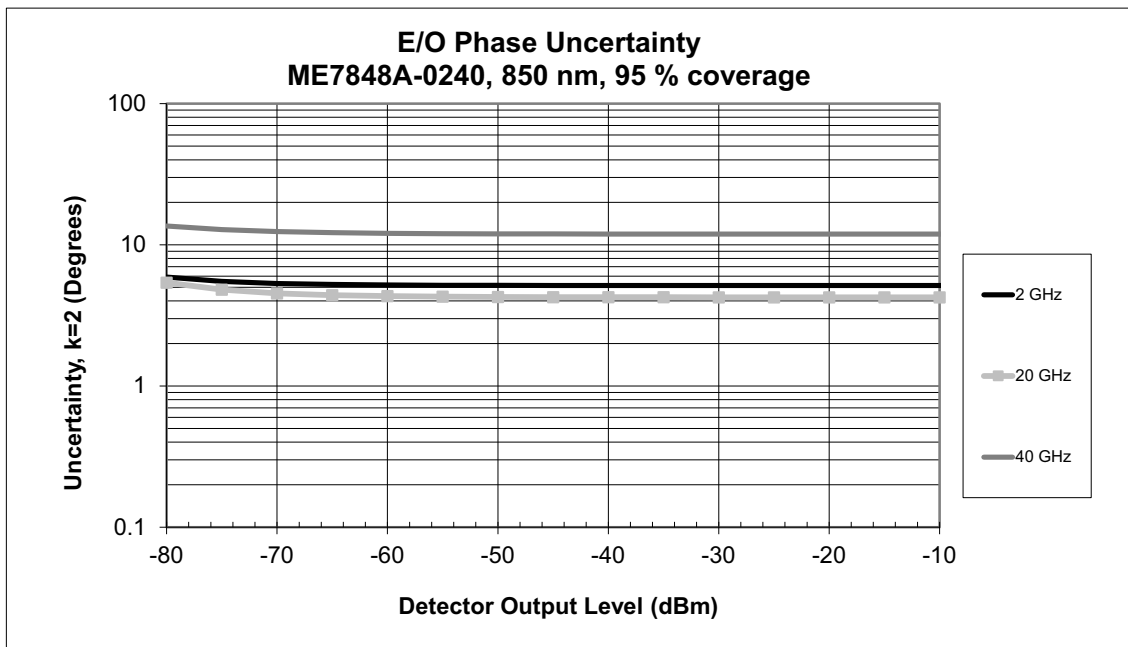
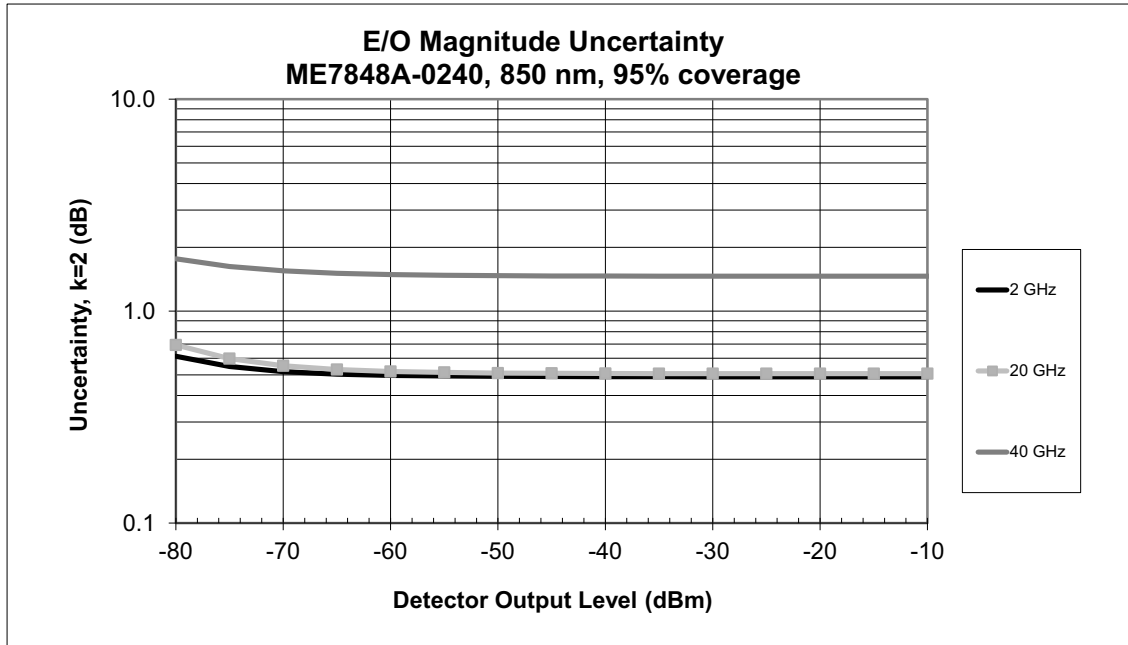

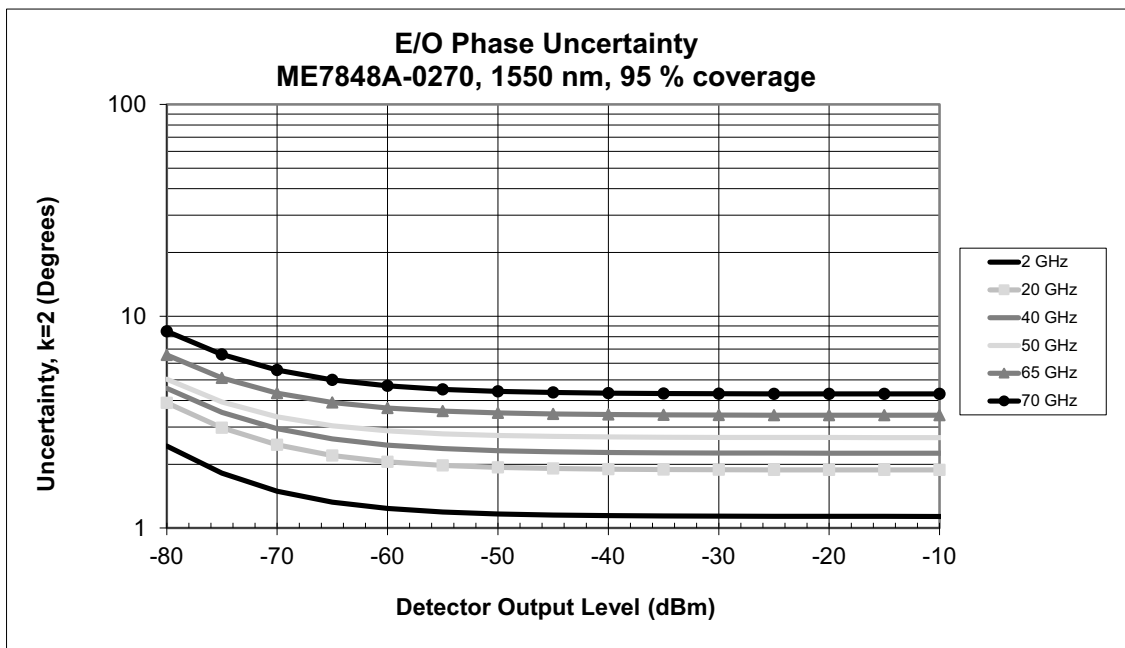
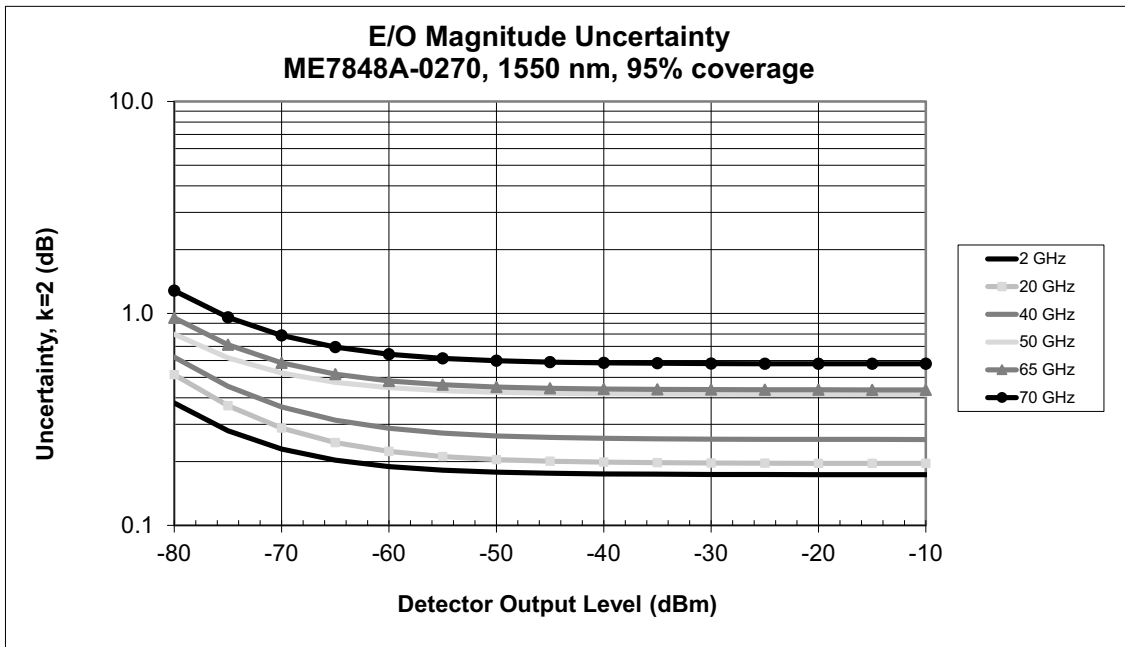

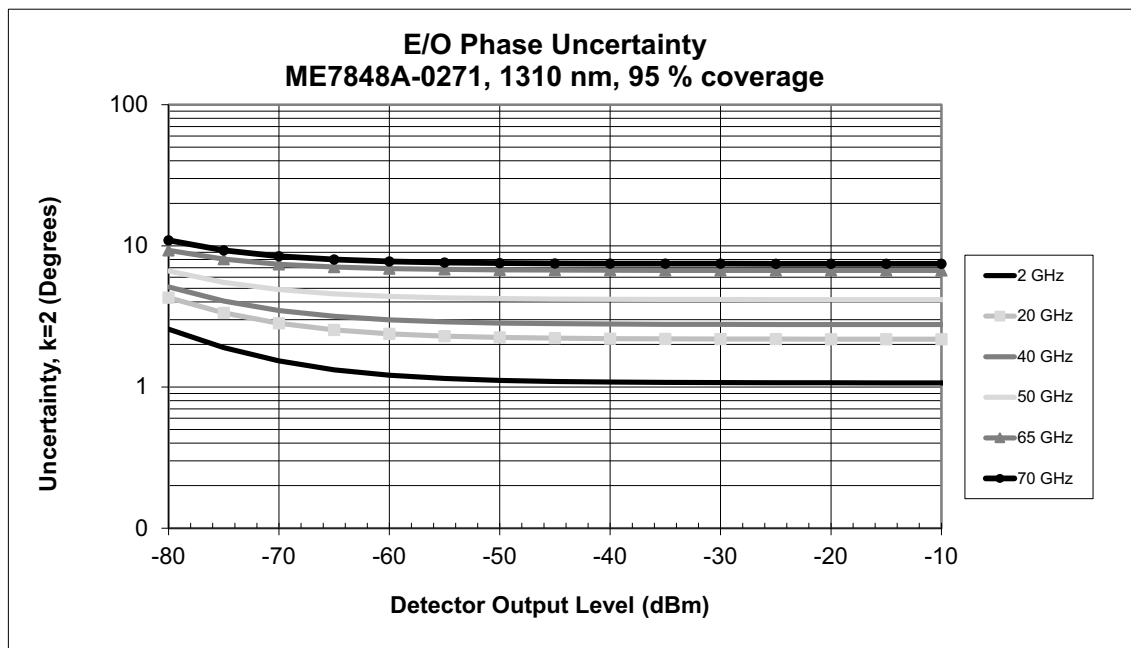
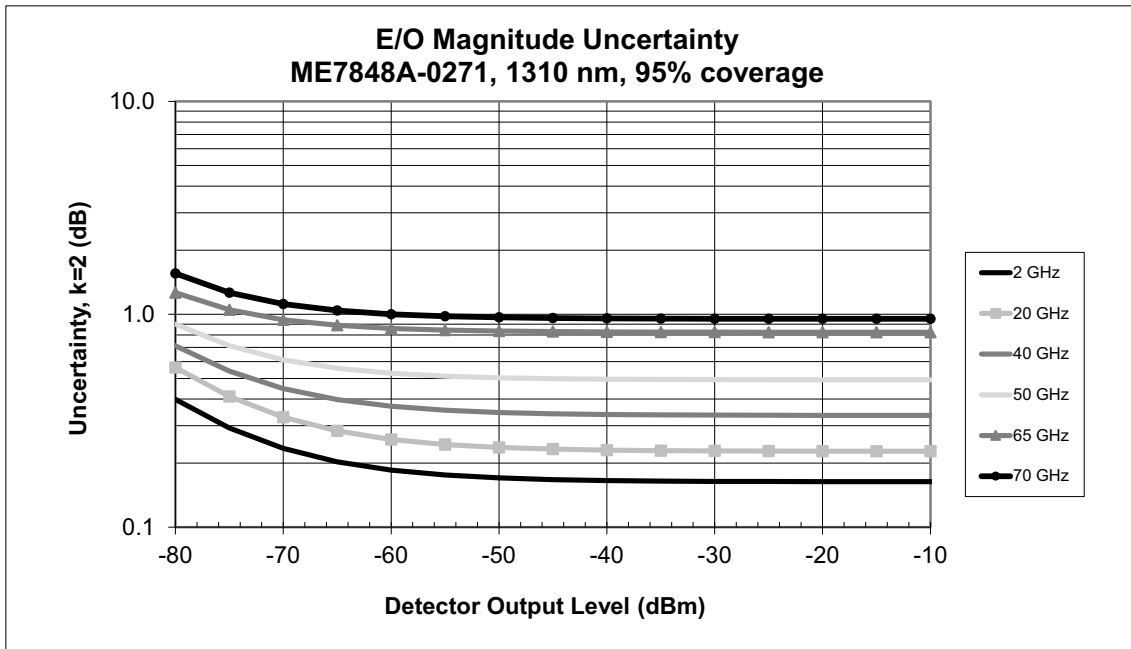

Absolute Response Uncertainty for E/O Measurements

Derived from the above relative frequency response uncertainty plus optical power uncertainty from the MN4775A series units and uncertainty in DC responsivity of the MN4765B O/E Calibration Module. Applies only when using the laser of the MN4775A. Uncertainty in the optical insertion loss of the DUT is not included in this calculation. The corresponding low frequency E/O $V_{\pi,rf}$ values below are based on default RF power, +5 dBm optical power (-0270), +2 dBm optical power (-0271), +4 dBm optical power (-0272), -3 dBm optical power (-0240), or +3 dBm optical power (-021x), and Anritsu O/E module specified low frequency responsivities. At higher frequencies, values scale with the roll-off. The table below assumes the presence of VNA Option 70 (70 kHz operation); otherwise the minimum frequency is 10 MHz.

- P1 received level -30 dBm (at low freq, $V_{\pi,rf}$ of 0.6 V, 0.4 V, or 1.1 V for -0240, -0271/2, or -0270, respectively)
- P2 received level -40 dBm (at low freq, $V_{\pi,rf}$ of 1.8 V, 1.1 V, or 3.5 V for -0240, -0271/2, or -0270, respectively)
- P3 received level -50 dBm (at low freq, $V_{\pi,rf}$ of 6 V, 3.6 V, or 11 V for -0240, -0271/2, or -0270, respectively)
- P4 received level -60 dBm (at low freq, $V_{\pi,rf}$ of 18 V, 11 V, or 35 V for -0240, -0271/2, or -0270, respectively)

Frequency (GHz)	ME7848A-0240 (dB)				ME7848A-0271 ^a (dB)				ME7848A-0270 ^a (dB)			
	P1	P2	P3	P4	P1	P2	P3	P4	P1	P2	P3	P4
70 kHz to 300 kHz	± 2.6	± 2.6	± 2.8	± 3.8	± 2.2	± 2.3	± 2.6	± 3.7	± 2.1	± 2.2	± 2.5	± 3.7
> 300 kHz to 2 MHz	± 2.2	± 2.2	± 2.3	± 2.4	± 2.0	± 2.0	± 2.1	± 2.2	± 2.0	± 2.1	± 2.1	± 2.2
> 2 MHz to 10 MHz	± 2.1	± 2.1	± 2.1	± 2.1	± 1.8	± 1.8	± 1.8	± 1.8	± 1.8	± 1.8	± 1.8	± 1.8
> 0.01 to < 2.5	± 2.0	± 2.0	± 2.0	± 2.0	± 1.7	± 1.7	± 1.7	± 1.7	± 1.7	± 1.7	± 1.7	± 1.7
2.5 to 5	± 2.0	± 2.0	± 2.0	± 2.0	± 1.7	± 1.7	± 1.7	± 1.7	± 1.7	± 1.7	± 1.7	± 1.7
> 5 to 20	± 2.0	± 2.0	± 2.0	± 2.0	± 1.7	± 1.7	± 1.7	± 1.8	± 1.7	± 1.7	± 1.7	± 1.8
> 20 to 38/40 ^b	± 3.0	± 3.0	± 3.0	± 3.0	± 1.8	± 1.8	± 1.8	± 1.8	± 1.8	± 1.8	± 1.8	± 1.8
> 38 to 50	-	-	-	-	± 2.0	± 2.0	± 2.0	± 2.0	± 1.9	± 2.0	± 2.0	± 2.0
> 50 to 65	-	-	-	-	± 2.3	± 2.3	± 2.3	± 2.3	± 2.0	± 2.0	± 2.0	± 2.0
> 65 to 67	-	-	-	-	± 2.5	± 2.5	± 2.5	± 2.5	± 2.1	± 2.1	± 2.1	± 2.1
> 67 to 70	-	-	-	-	± 2.5	± 2.5	± 2.5	± 2.5	± 2.1	± 2.1	± 2.1	± 2.1

- a. For Option -0272, use the Option -0271 values for 1310 nm operation. Use the Option -0270 values for 1550 nm operation.
- b. 38 GHz applies for Option -027x systems; 40 GHz applies for the Option -0240 system.

- P1 received level -30 dBm (at low freq, $V_{\pi,rf}$ of 0.5 V pk for 110 GHz systems)
- P2 received level -40 dBm (at low freq, $V_{\pi,rf}$ of 1.7 V pk for 110 GHz systems)
- P3 received level -50 dBm (at low freq, $V_{\pi,rf}$ of 5.2 V pk for 110 GHz systems)
- P4 received level -60 dBm (at low freq, $V_{\pi,rf}$ of 16.5 V pk for 110 GHz systems)

Frequency (GHz)	ME7848A/E-0210 (dB)				ME7848A/E-0211 ^a (dB)			
	P1	P2	P3	P4	P1	P2	P3	P4
70 kHz to 300 kHz	± 2.1	± 2.2	± 2.5	± 3.7	± 2.9	± 3.0	± 3.3	± 4.5
> 300 kHz to 2 MHz	± 2.0	± 2.1	± 2.1	± 2.2	± 2.8	± 2.9	± 2.9	± 3.0
> 2 MHz to 10 MHz	± 2.0	± 2.0	± 2.0	± 2.0	± 2.5	± 2.5	± 2.5	± 2.5
> 0.01 to < 2.5	± 1.9	± 1.9	± 1.9	± 1.9	± 2.3	± 2.3	± 2.3	± 2.3
2.5 to 10	± 1.8	± 1.8	± 1.8	± 1.8	± 2.1	± 2.1	± 2.1	± 2.1
> 10 to 24	± 1.8	± 1.8	± 1.8	± 1.8	± 1.8	± 1.8	± 1.8	± 1.8
> 24 to 40	± 1.8	± 1.8	± 1.8	± 1.8	± 1.8	± 1.8	± 1.8	± 1.8
> 40 to 54	± 1.8	± 1.8	± 1.8	± 1.9	± 1.8	± 1.8	± 1.8	± 1.9
> 54 to 60	± 1.9	± 1.9	± 1.9	± 1.9	± 1.9	± 1.9	± 1.9	± 1.9
> 60 to 65	± 2.0	± 2.0	± 2.0	± 2.0	± 2.0	± 2.0	± 2.0	± 2.0
> 65 to 70	± 2.0	± 2.0	± 2.0	± 2.1	± 2.0	± 2.0	± 2.0	± 2.1
> 70 to 80	± 2.1	± 2.1	± 2.1	± 2.1	± 2.1	± 2.1	± 2.1	± 2.1
> 80 to 90	± 2.1	± 2.1	± 2.1	± 2.1	± 2.1	± 2.1	± 2.1	± 2.1
> 90 to 100	± 2.1	± 2.1	± 2.1	± 2.2	± 2.1	± 2.1	± 2.1	± 2.2
> 100 to 110	± 2.2	± 2.2	± 2.3	± 2.3	± 2.2	± 2.2	± 2.3	± 2.3

- a. Typical.

Note that absolute responsivity is not directly plotted on the instrument but that calculation can be easily implemented using optical power, O/E responsivities, and the VectorStar equation editor.

O/E Measurements

Noise Floor for O/E Measurements

Expressed in terms of dBm (RMS) in a 10 Hz IFBW (average values are typically 4-6 dB lower (more negative). Based on maximum nominal optical power from modulator (+5 dBm (-0270), +2 dBm (-0271), +4 dBm (-0272), -3 dBm (-0240), or +3 dBm optical power (-021x)), and derived from de-embedding the absolute E/O response. Interconnecting fiber loss (1m) neglected. 1 m VNA cable loss is included. 'Normal' refers to the conventional VNA coupler configuration. 'Reversed' refers to the use of the loop access to reverse the orientation of the port 2 test couplers (requires changing front and rear panel access loop configuration). The table below assumes the presence of VNA Option 70 (70 kHz operation); otherwise the minimum frequency is 10 MHz.

Frequency (GHz)	ME7848A-0240 (dBm)				ME7848A-0271 ^a (dBm)				ME7848A-0270 ^a (dBm)			
	051 Normal	051 Reversed	062 Normal	062 Reversed	051 Normal	051 Reversed	062 Normal	062 Reversed	051 Normal	051 Reversed	062 Normal	062 Reversed
70 kHz to 300 kHz	-54	-64	-54	-64	-66	-76	-66	-76	-66	-76	-66	-76
> 300 kHz to 2 MHz	-59	-69	-59	-69	-71	-81	-71	-81	-71	-81	-71	-81
> 2 MHz to 10 MHz	-64	-74	-64	-74	-76	-86	-76	-86	-76	-86	-76	-86
> 0.01 to < 2.5	-72	-79	-72	-79	-86	-93	-86	-93	-86	-93	-86	-93
2.5 to 5	-75	-82	-75	-82	-87	-94	-87	-94	-87	-94	-87	-94
> 5 to 20	-74	-81	-74	-81	-84	-91	-84	-91	-84	-91	-84	-91
> 20 to 38/40 ^b	-64	-66	-63	-65	-80	-82	-80	-81	-80	-82	-79	-81
> 38 to 50	-	-	-	-	-75	-77	-74	-75	-75	-76	-74	-75
> 50 to 65	-	-	-	-	-71	-69	-71	-69	-71	-69	-69	-67
> 65 to 67	-	-	-	-	-68	-65	-65	-62	-68	-65	-65	-62
> 67 to 70	-	-	-	-	-64	-61	-60	-58	-64	-61	-60	-58

a. For Option -0272, use the Option -0271 values for 1310 nm operation. Use the Option -0270 values for 1550 nm operation, but add 2 dB.

b. 38 GHz applies for Option -027x systems; 40 GHz applies for the Option -0240 system.

Frequency (GHz)	ME7848A/E-0210 (dBm)			ME7848A/E-0211 (dBm)		
	000 Normal	051 Normal	062 Normal	000 Normal	051 Normal	062 Normal
70 kHz to 300 kHz	-59	-59	-59	-59	-59	-59
> 300 kHz to 2 MHz	-71	-71	-71	-71	-71	-71
> 2 MHz to 10 MHz	-85	-85	-85	-85	-85	-85
> 0.01 to < 2.5	-83	-83	-83	-83	-83	-83
2.5 to 10	-86	-85	-84	-86	-85	-84
> 10 to 24	-81	-79	-79	-81	-79	-79
> 24 to 40	-79	-78	-77	-79	-78	-77
> 40 to 54	-82	-81	-79	-82	-81	-79
> 54 to 60	-79	-79	-79	-79	-79	-79
> 60 to 65	-79	-79	-79	-79	-79	-79
> 65 to 70	-78	-78	-78	-78	-78	-78
> 70 to 80	-76	-76	-76	-76	-76	-76
> 80 to 90	-74	-74	-74	-74	-74	-74
> 90 to 100	-69	-69	-69	-69	-69	-69
> 100 to 110	-70	-70	-70	-70	-70	-70

Expressed in terms of measurable optical response dB (A/W) (defined as the output RF current per unit equivalent modulated optical power) at +5 dBm optical (-0270), +2 dBm optical (-0271), +4 dBm optical power (-0272), -3 dBm optical (-0240), or +3 dBm optical power (-021x). This is an RMS noise floor definition in a 10 Hz IFBW and is derived from de-embedding the absolute E/O response (average values are typically 4-6 dB lower (more negative)). Interconnecting fiber loss (1m) is neglected. 1m VNA cable loss is included. The value is based on -10 dBm VNA port power for the -027x/-021x models and +5 dBm VNA port power for the -0240 model (default power for 70 GHz and 40 GHz VNAs, respectively). 'Normal' refers to the conventional VNA coupler configuration. 'Reversed' refers to the use of the loop access to reverse the orientation of the port 2 test coupler. The table below assumes the presence of VNA Option 70 (70 kHz operation); otherwise the minimum frequency is 10 MHz.

Frequency (GHz)	ME7848A-0240 (dB (A/W))				ME7848A-0271 ^a (dB (A/W))				ME7848A-0270 ^a (dB (A/W))			
	051 Normal	051 Reversed	062 Normal	062 Reversed	051 Normal	051 Reversed	062 Normal	062 Reversed	051 Normal	051 Reversed	062 Normal	062 Reversed
70 kHz to 300 kHz	-43	-53	-43	-53	-61	-71	-61	-71	-61	-71	-61	-71
> 300 kHz to 2 MHz	-48	-58	-48	-58	-66	-76	-66	-76	-66	-76	-66	-76
> 2 MHz to 10 MHz	-53	-63	-53	-63	-71	-81	-71	-81	-71	-81	-71	-81
> 0.01 to < 2.5	-61	-68	-61	-68	-81	-88	-81	-88	-81	-88	-81	-88
2.5 to 5	-64	-71	-64	-71	-82	-89	-82	-89	-82	-89	-82	-89
> 5 to 20	-74	-81	-74	-81	-80	-86	-80	-86	-80	-86	-80	-86
> 20 to 38/40 ^b	-53	-55	-52	-54	-77	-79	-77	-78	-77	-79	-76	-79
> 38 to 50	-	-	-	-	-70	-72	-69	-70	-70	-71	-69	-70
> 50 to 65	-	-	-	-	-66	-64	-66	-64	-66	-64	-64	-62
> 65 to 67	-	-	-	-	-63	-60	-60	-57	-63	-60	-60	-57
> 67 to 70	-	-	-	-	-59	-56	-55	-53	-59	-56	-55	-53

a. For Option -0272, use the Option -0271 values for 1310 nm operation. Use the Option -0270 values for 1550 nm operation.

b. 38 GHz applies for Option -027x systems; 40 GHz applies for the Option -0240 system.

Frequency (GHz)	ME7848A/E-0210 (dB (A/W))			ME7848A/E-0211 (dB (A/W))		
	000 Normal	051 Normal	062 Normal	000 Normal	051 Normal	062 Normal
70 kHz to 300 kHz	-58	-58	-58	-58	-58	-58
> 300 kHz to 2 MHz	-70	-70	-70	-70	-70	-70
> 2 MHz to 10 MHz	-84	-84	-84	-84	-84	-84
> 0.01 to < 2.5	-82	-82	-82	-82	-82	-82
2.5 to 10	-85	-84	-83	-85	-84	-83
> 10 to 24	-80	-78	-78	-80	-78	-78
> 24 to 40	-78	-77	-76	-78	-77	-76
> 40 to 54	-81	-80	-78	-81	-80	-78
> 54 to 60	-78	-78	-78	-78	-78	-78
> 60 to 65	-78	-78	-78	-78	-78	-78
> 65 to 70	-77	-77	-77	-77	-77	-77
> 70 to 80	-75	-75	-75	-75	-75	-75
> 80 to 90	-73	-73	-73	-73	-73	-73
> 90 to 100	-68	-68	-68	-68	-68	-68
> 100 to 110	-69	-69	-69	-69	-69	-69

Frequency Response Repeatability for O/E Measurements

Typical and in dB terms, 10 Hz IFBW at various composite response levels (P1-P4) at the receiving VNA port (assumed normal (not reversed)), excludes fiber connector effects. The composite response is affected by the optical power level and the O/E responsivity. Assumes nominal 90 minute warm-up time and ignores DUT bias system stability effects. The corresponding low frequency O/E responsivity values below are based on default RF power, +5 dBm optical power (-0270), +2 dBm optical power (-0271), +4 dBm optical power (-0272), -3 dBm optical power (-0240), or +3 dBm optical power (-021x), and Anritsu E/O module specified low frequency $V_{\pi,rf}$. At higher frequencies, values scale with the roll-off. The table below assumes the presence of VNA Option 70 (70 kHz operation); otherwise the minimum frequency is 10 MHz.

- P1 received level -30 dBm (low frequency, η_{det} of 1.25 A/W, 6.9 A/W, or 3.5 A/W for -0240, -0271/2, or -0270, respectively)
- P2 received level -40 dBm (low frequency, η_{det} of 0.35 A/W, 2.2 A/W, or 1.1 A/W for -0240, -0271/2, or -0270, respectively)
- P3 received level -50 dBm (low frequency, η_{det} of 0.12 A/W, 0.69 A/W, or 0.35 A/W for -0240, -0271/2, or -0270, respectively)
- P4 received level -60 dBm (low frequency, η_{det} of 0.04 A/W, 0.22 A/W, or 0.11 A/W for -0240, -0271/2, or -0270, respectively)

Frequency (GHz)	ME7848A-0240 (dB)				ME7848A-0271 ^a (dB)				ME7848A-0270 ^a (dB)			
	P1	P2	P3	P4	P1	P2	P3	P4	P1	P2	P3	P4
70 kHz to 300 kHz	± 0.07	± 0.1	± 0.15	± 0.2	± 0.07	± 0.1	± 0.15	± 0.2	± 0.07	± 0.1	± 0.15	± 0.2
> 300 kHz to 2 MHz	± 0.05	± 0.07	± 0.1	± 0.15	± 0.05	± 0.07	± 0.1	± 0.15	± 0.05	± 0.07	± 0.1	± 0.15
> 2 MHz to 10 MHz	± 0.05	± 0.05	± 0.05	± 0.07	± 0.05	± 0.05	± 0.05	± 0.05	± 0.03	± 0.03	± 0.03	± 0.03
> 0.01 to < 2.5	± 0.05	± 0.05	± 0.05	± 0.07	± 0.05	± 0.05	± 0.05	± 0.05	± 0.03	± 0.03	± 0.03	± 0.03
2.5 to 5	± 0.03	± 0.05	± 0.05	± 0.05	± 0.05	± 0.05	± 0.05	± 0.05	± 0.03	± 0.03	± 0.03	± 0.03
> 5 to 20	± 0.03	± 0.05	± 0.05	± 0.05	± 0.05	± 0.05	± 0.05	± 0.05	± 0.03	± 0.03	± 0.03	± 0.03
> 20 to 38/40 ^b	± 0.05	± 0.07	± 0.07	± 0.09	± 0.05	± 0.05	± 0.05	± 0.05	± 0.03	± 0.05	± 0.05	± 0.05
> 38 to 50	-	-	-	-	± 0.05	± 0.05	± 0.05	± 0.05	± 0.03	± 0.05	± 0.05	± 0.05
> 50 to 65	-	-	-	-	± 0.05	± 0.05	± 0.05	± 0.05	± 0.05	± 0.05	± 0.05	± 0.05
> 65 to 67	-	-	-	-	± 0.05	± 0.05	± 0.05	± 0.07	± 0.05	± 0.05	± 0.05	± 0.05
> 67 to 70	-	-	-	-	± 0.07	± 0.07	± 0.07	± 0.1	± 0.07	± 0.07	± 0.07	± 0.07

- a. For -0272, use the -0271 values for 1310 nm operation. Use the -0270 values for 1550 nm operation.
- b. 38 GHz applies for -027x systems; 40 GHz applies for -0240 system.

- P1 received level -30 dBm (low frequency, η_{det} of 1.6 A/W for 110 GHz systems)
- P2 received level -40 dBm (low frequency, η_{det} of 0.50 A/W for 110 GHz systems)
- P3 received level -50 dBm (low frequency, η_{det} of 0.16 A/W for 110 GHz systems)
- P4 received level -60 dBm (low frequency, η_{det} of 0.05 A/W for 110 GHz systems)

Frequency (GHz)	ME7848A/E-0210 (dB)				ME7848A/E-0211 (dB)			
	P1	P2	P3	P4	P1	P2	P3	P4
70 kHz to 300 kHz	± 0.07	± 0.10	± 0.15	± 0.20	± 0.10	± 0.15	± 0.20	± 0.25
> 300 kHz to 2 MHz	± 0.05	± 0.07	± 0.10	± 0.15	± 0.10	± 0.10	± 0.15	± 0.20
> 2 MHz to 10 MHz	± 0.03	± 0.03	± 0.03	± 0.03	± 0.07	± 0.07	± 0.07	± 0.07
> 0.01 to < 2.5	± 0.03	± 0.03	± 0.03	± 0.03	± 0.07	± 0.07	± 0.07	± 0.07
2.5 to 10	± 0.03	± 0.03	± 0.03	± 0.03	± 0.03	± 0.03	± 0.03	± 0.05
> 10 to 24	± 0.05	± 0.05	± 0.05	± 0.05	± 0.05	± 0.05	± 0.05	± 0.05
> 24 to 40	± 0.05	± 0.05	± 0.05	± 0.05	± 0.05	± 0.05	± 0.05	± 0.05
> 40 to 54	± 0.05	± 0.05	± 0.05	± 0.05	± 0.05	± 0.05	± 0.05	± 0.06
> 54 to 60	± 0.05	± 0.05	± 0.05	± 0.06	± 0.05	± 0.05	± 0.07	± 0.08
> 60 to 65	± 0.05	± 0.05	± 0.06	± 0.06	± 0.05	± 0.05	± 0.07	± 0.05
> 65 to 70	± 0.06	± 0.06	± 0.06	± 0.07	± 0.07	± 0.07	± 0.07	± 0.10
> 70 to 80	± 0.06	± 0.06	± 0.06	± 0.07	± 0.07	± 0.07	± 0.10	± 0.10
> 80 to 90	± 0.06	± 0.06	± 0.07	± 0.08	± 0.07	± 0.10	± 0.10	± 0.10
> 90 to 100	± 0.07	± 0.07	± 0.08	± 0.10	± 0.10	± 0.10	± 0.10	± 0.12
> 100 to 110	± 0.08	± 0.08	± 0.08	± 0.10	± 0.10	± 0.12	± 0.12	± 0.15

Frequency Response Uncertainty for O/E Measurements

Includes residual VNA calibration errors, electrical mismatch uncertainties, noise floor effects, characterization uncertainties, and repeatability. A full two-port calibration (using a 3654D calibration kit for the -027x systems, a 3652A calibration kit for the -0240 system, or a 3656C calibration kit for -021x systems) is assumed and DUT mismatch is assumed to not be worse than -10 dB. 10 Hz IFBW is assumed and drive power is assumed low enough that linearity issues are not present. Uncertainties are on a 95% basis and are in single-sided dB terms and indexed to the power received by the VNA. The corresponding low frequency O/E responsivity values below are based on default RF power, +5 dBm optical power (-0270) or +2 dBm optical power (-0271), +4 dBm optical power (-0272), -3 dBm optical power (-0240), or +3 dBm optical power (-021x), and Anritsu E/O module specified low frequency $V_{\pi,rf}$. At higher frequencies, values scale with the roll-off. The table below assumes the presence of VNA Option 70 (70 kHz operation); otherwise the minimum frequency is 10 MHz.

- P1 received level -30 dBm (low frequency, η_{det} of 1.2 A/W, 6.9 A/W, or 3.5 A/W for -0240, -0271/2, or -0270, respectively)
- P2 received level -40 dBm (low frequency, η_{det} of 0.35 A/W, 2.2 A/W, or 1.1 A/W for -0240, -0271/2, or -0270, respectively)
- P3 received level -50 dBm (low frequency, η_{det} of 0.12 A/W, 0.69 A/W, or 0.35 A/W for -0240, -0271/2, or -0270, respectively)
- P4 received level -60 dBm (low frequency, η_{det} of 0.04 A/W, 0.22 A/W, or 0.11 A/W for -0240, -0271/2, or -0270, respectively)

Frequency (GHz)	ME7848A-0240 (dB)				ME7848A-0271 ^a (dB)				ME7848A-0270 ^a (dB)			
	P1	P2	P3	P4	P1	P2	P3	P4	P1	P2	P3	P4
70 kHz to 300 kHz	± 1.1	± 1.1	± 1.4	± 2.6	± 0.7	± 0.8	± 1.2	± 2.6	± 0.7	± 0.8	± 1.1	± 2.5
> 300 kHz to 2 MHz	± 0.8	± 0.8	± 0.8	± 0.9	± 0.6	± 0.6	± 0.6	± 0.7	± 0.6	± 0.6	± 0.6	± 0.7
> 2 MHz to 10 MHz	± 0.6	± 0.6	± 0.6	± 0.6	± 0.3	± 0.4	± 0.4	± 0.4	± 0.3	± 0.3	± 0.3	± 0.3
> 0.01 to < 2.5	± 0.5	± 0.5	± 0.5	± 0.5	± 0.2	± 0.2	± 0.2	± 0.2	± 0.2	± 0.2	± 0.2	± 0.2
2.5 to 5	± 0.5	± 0.5	± 0.5	± 0.5	± 0.2	± 0.2	± 0.2	± 0.2	± 0.2	± 0.2	± 0.2	± 0.2
> 5 to 20	± 0.5	± 0.5	± 0.5	± 0.5	± 0.3	± 0.3	± 0.3	± 0.3	± 0.2	± 0.3	± 0.3	± 0.3
> 20 to 38/40 ^b	± 1.6	± 1.6	± 1.6	± 1.6	± 0.4	± 0.4	± 0.4	± 0.4	± 0.3	± 0.3	± 0.3	± 0.3
> 38 to 50	-	-	-	-	± 0.5	± 0.6	± 0.6	± 0.6	± 0.5	± 0.5	± 0.5	± 0.5
> 50 to 65	-	-	-	-	± 0.9	± 0.9	± 0.9	± 0.9	± 0.5	± 0.5	± 0.5	± 0.6
> 65 to 67	-	-	-	-	± 1.0	± 1.0	± 1.0	± 1.1	± 0.7	± 0.7	± 0.7	± 0.7
> 67 to 70	-	-	-	-	± 1.0	± 1.0	± 1.0	± 1.1	± 0.7	± 0.7	± 0.7	± 0.7

a. For Option -0272, use the Option -0271 values for 1310 nm operation. Use the Option -0270 values for 1550 nm operation.

b. 38 GHz applies for Option -027x systems; 40 GHz applies for the Option -0240 system.

- P1 received level -30 dBm (low frequency, η_{det} of 1.6 A/W for 110 GHz systems)
- P2 received level -40 dBm (low frequency, η_{det} of 0.50 A/W for 110 GHz systems)
- P3 received level -50 dBm (low frequency, η_{det} of 0.16 A/W for 110 GHz systems)
- P4 received level -60 dBm (low frequency, η_{det} of 0.05 A/W for 110 GHz systems)

Frequency (GHz)	ME7848A/E-0210 (dB)				ME7848A/E-0211 ^a (dB)			
	P1	P2	P3	P4	P1	P2	P3	P4
70 kHz to 300 kHz	± 0.7	± 0.8	± 1.1	± 2.5	± 1.5	± 1.6	± 1.9	± 3.3
> 300 kHz to 2 MHz	± 0.6	± 0.6	± 0.6	± 0.7	± 1.3	± 1.3	± 1.3	± 1.4
> 2 MHz to 10 MHz	± 0.5	± 0.5	± 0.5	± 0.5	± 1.0	± 1.0	± 1.0	± 1.0
> 0.01 to < 2.5	± 0.4	± 0.4	± 0.4	± 0.4	± 0.8	± 0.8	± 0.8	± 0.8
2.5 to 10	± 0.3	± 0.3	± 0.3	± 0.3	± 0.6	± 0.6	± 0.6	± 0.6
> 10 to 24	± 0.3	± 0.3	± 0.3	± 0.4	± 0.4	± 0.4	± 0.4	± 0.5
> 24 to 40	± 0.4	± 0.4	± 0.4	± 0.4	± 0.4	± 0.4	± 0.4	± 0.5
> 40 to 54	± 0.4	± 0.4	± 0.4	± 0.5	± 0.4	± 0.4	± 0.4	± 0.5
> 54 to 60	± 0.4	± 0.4	± 0.4	± 0.5	± 0.5	± 0.5	± 0.5	± 0.6
> 60 to 65	± 0.5	± 0.5	± 0.5	± 0.6	± 0.6	± 0.6	± 0.6	± 0.6
> 65 to 70	± 0.6	± 0.6	± 0.6	± 0.6	± 0.6	± 0.6	± 0.6	± 0.7
> 70 to 80	± 0.6	± 0.6	± 0.6	± 0.7	± 0.7	± 0.7	± 0.7	± 0.7
> 80 to 90	± 0.6	± 0.6	± 0.6	± 0.7	± 0.7	± 0.7	± 0.7	± 0.8
> 90 to 100	± 0.7	± 0.7	± 0.7	± 0.8	± 0.8	± 0.8	± 0.8	± 0.9
> 100 to 110	± 0.8	± 0.8	± 0.8	± 0.9	± 0.9	± 0.9	± 0.9	± 1.0

a. Typical.

Curves showing the uncertainty relationships in more detail are below. The optical power and responsivity of the DUT (coupled with the responsivity of the ME7848A system) and any RF networks in the setup (e.g., cables and probes) will determine the x-axis value.

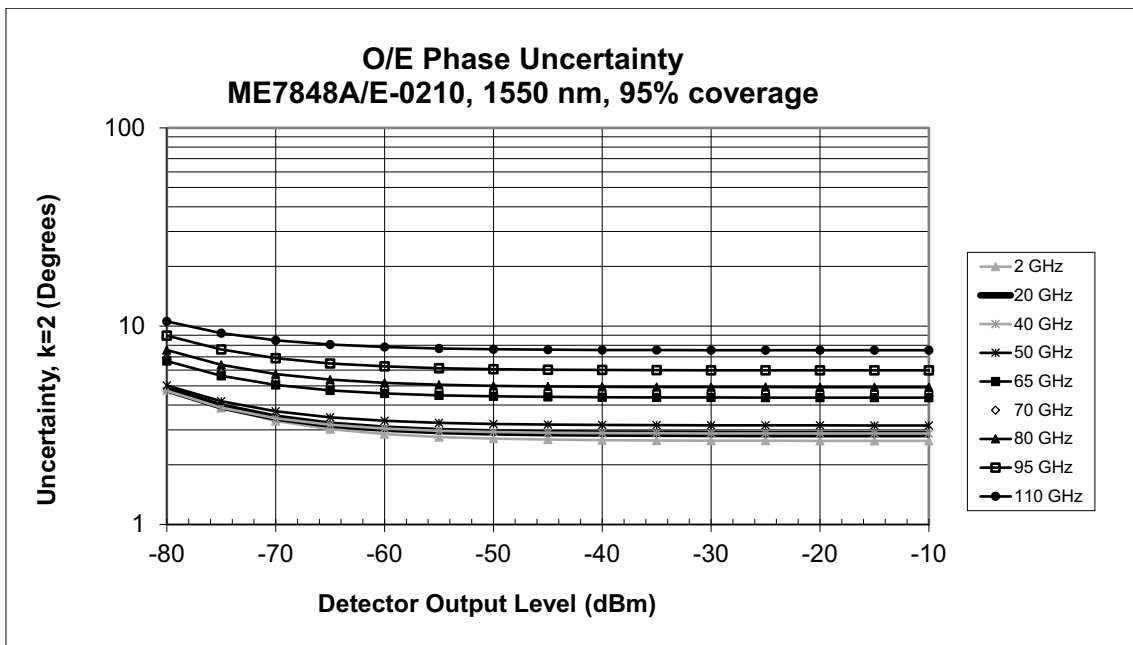
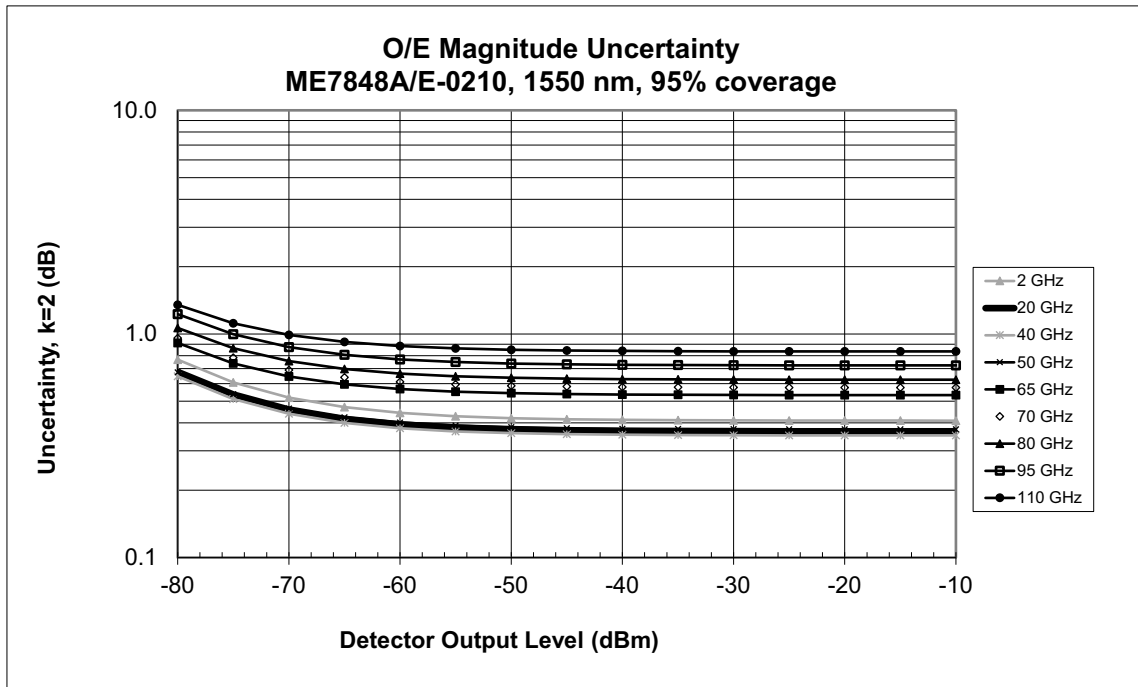

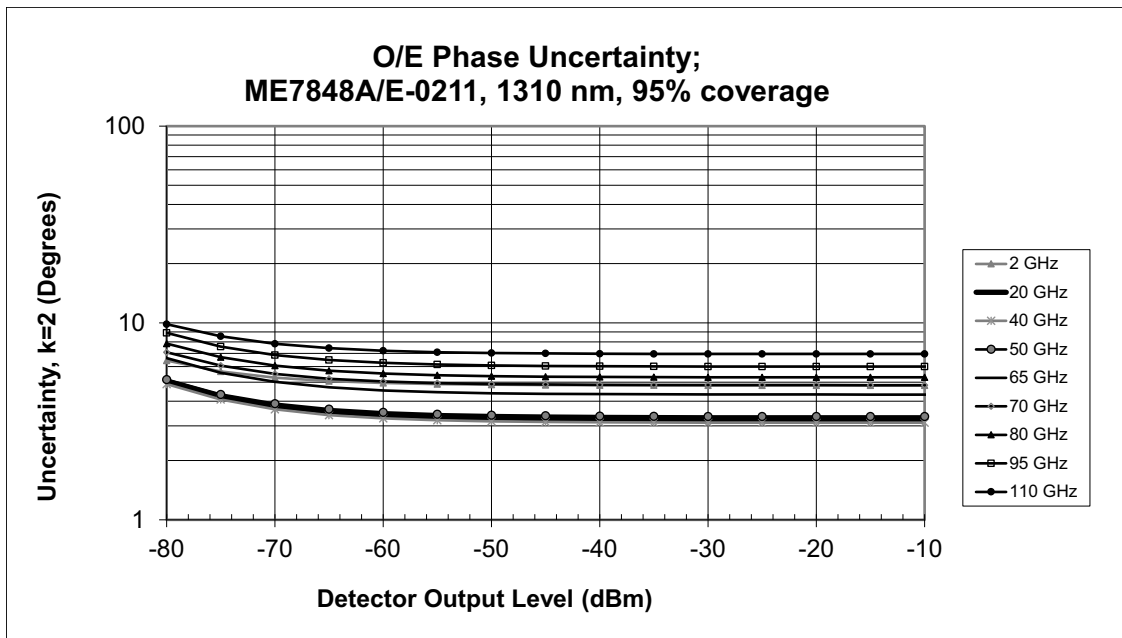
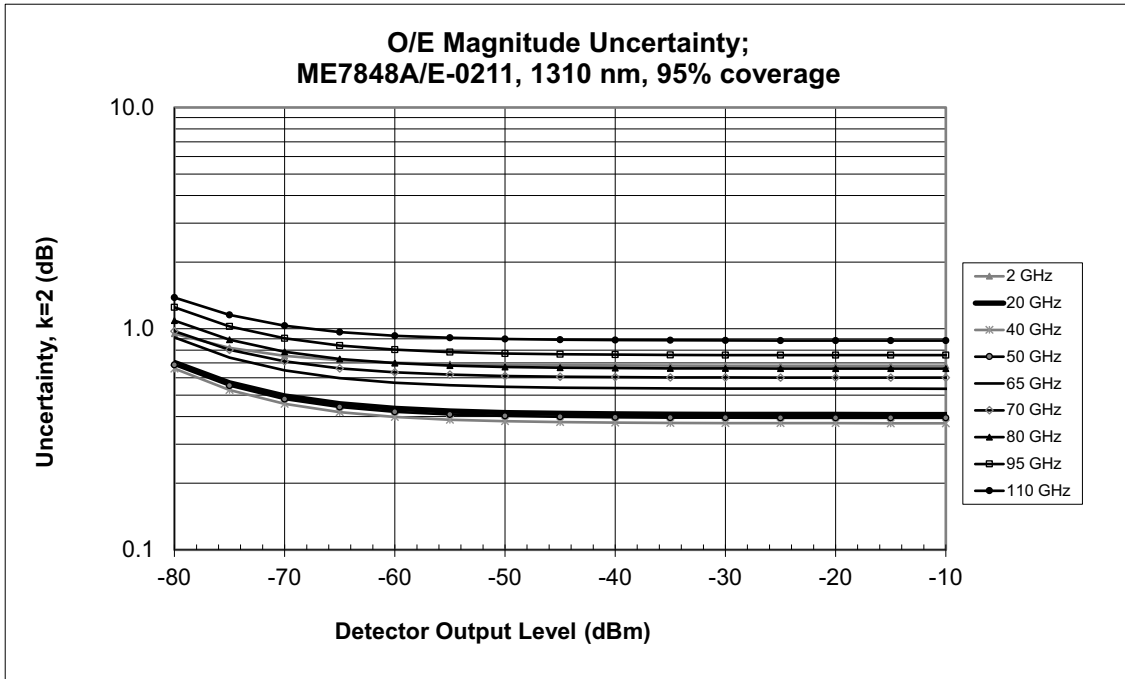

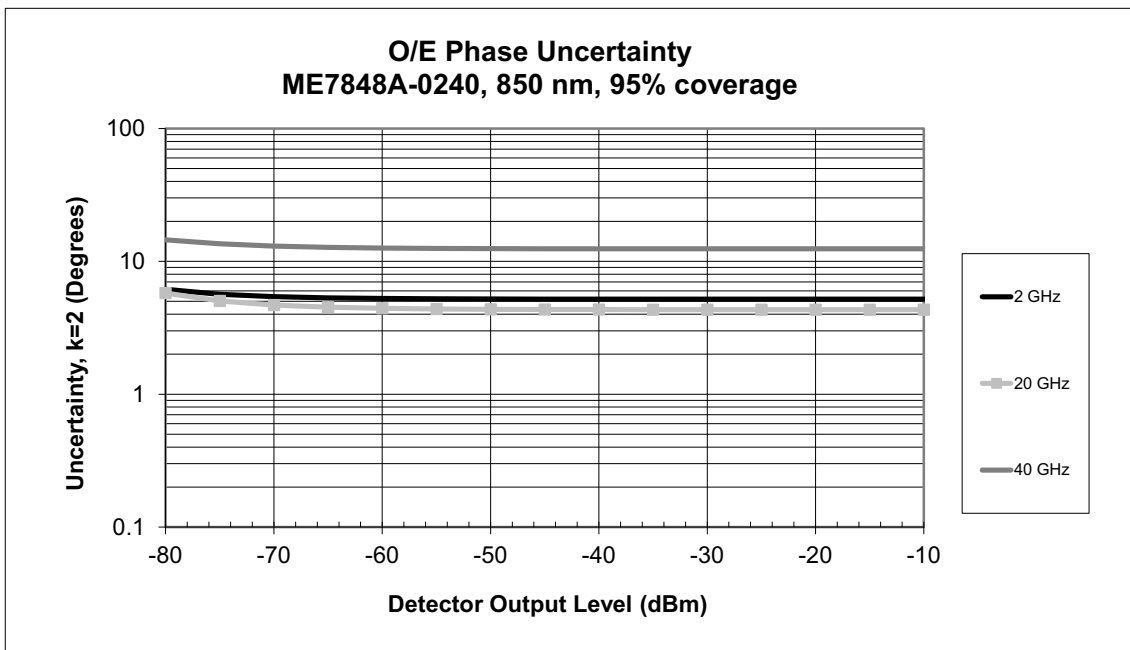
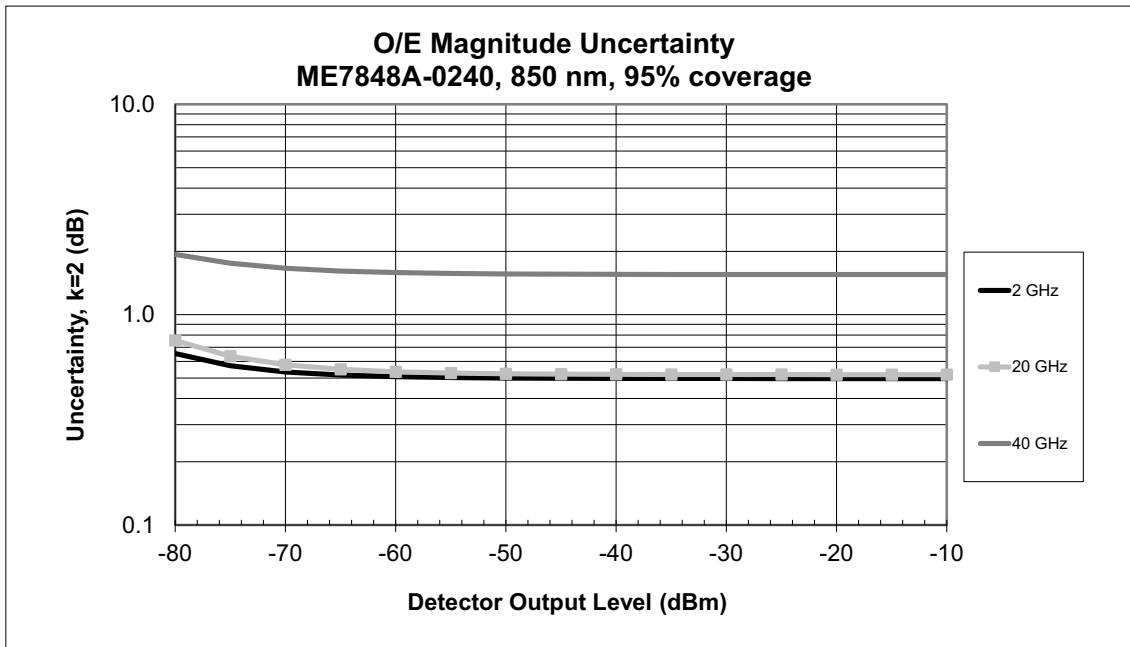

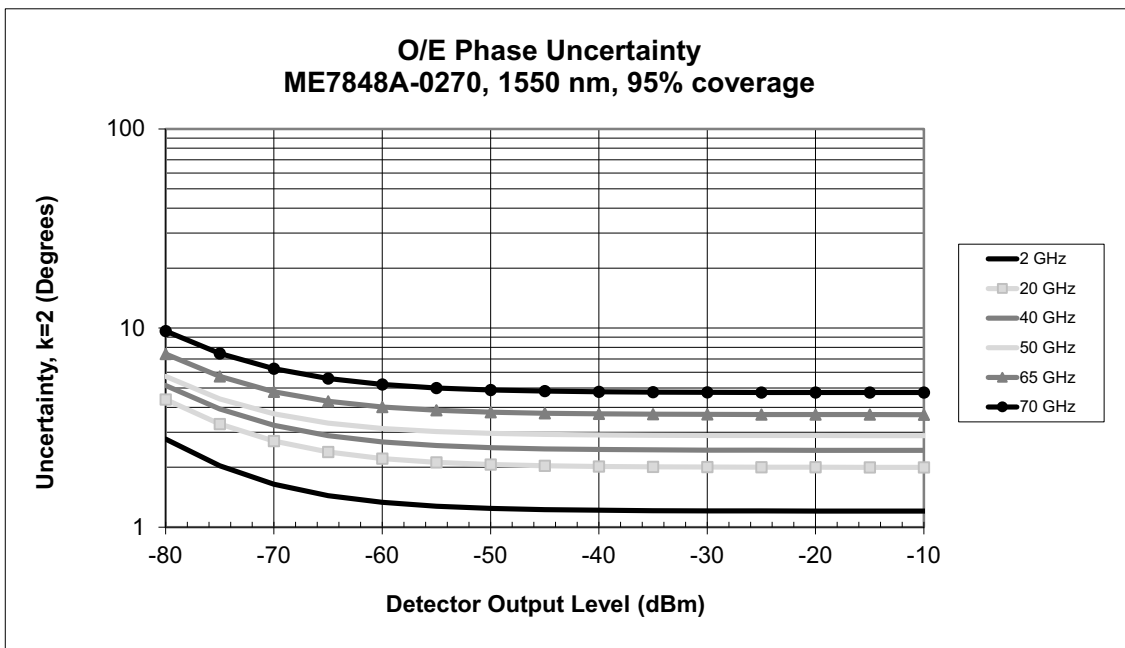
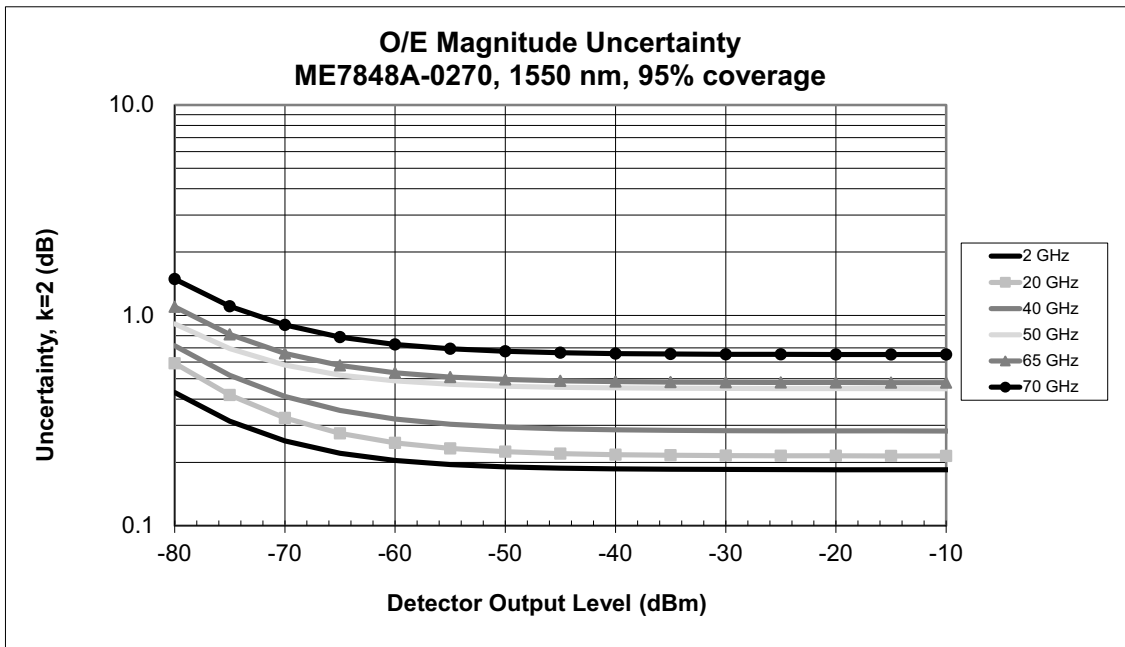

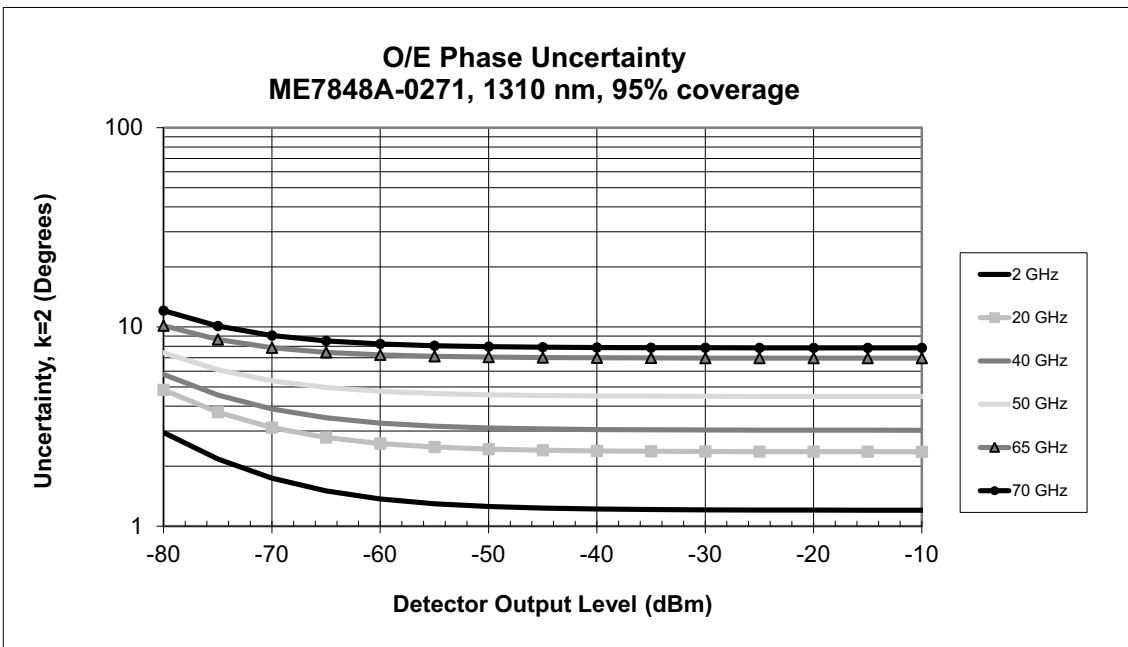
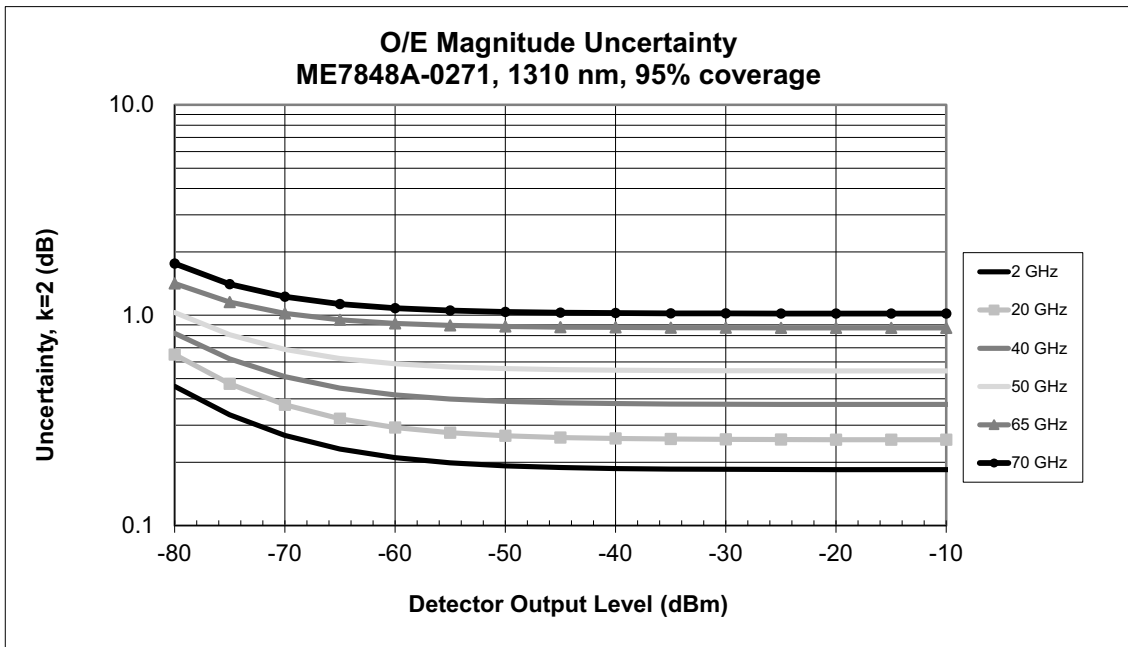

Absolute Response Uncertainty for O/E Measurements

Derived from the above relative frequency response uncertainty plus optical power uncertainty from the MN4775A series units and uncertainty in DC responsivity of the MN4765B O/E Calibration Module. Applies only when using the laser of the MN4775A. The corresponding low frequency O/E responsivity values below are based on default RF power, +5 dBm optical power (-0270), +2 dBm optical power (-0271), +4 dBm optical power (-0272), -3 dBm optical power (-0240), or +3 dBm (-021x), and Anritsu E/O module specified low frequency $V_{\pi,rf}$. At higher frequencies, values scale with the roll-off. The table below assumes the presence of VNA Option 70 (70 kHz operation); otherwise the minimum frequency is 10 MHz.

- P1 received level -30 dBm (low frequency, η_{det} of 1.2 A/W, 6.9 A/W or 3.5 A/W for -0240, -0271/2, or -0270, respectively)
- P2 received level -40 dBm (low frequency, η_{det} of 0.35 A/W, 2.2 A/W or 1.1 A/W for -0240, -0271/2, or -0270, respectively)
- P3 received level -50 dBm (low frequency, η_{det} of 0.12 A/W, 0.69 A/W or 0.35 A/W for -0240, -0271/2, or -0270, respectively)
- P4 received level -60 dBm (low frequency, η_{det} of 0.04 A/W, 0.22 A/W or 0.11 A/W for -0240, -0271/2, or -0270, respectively)

Frequency (GHz)	ME7848A-0240 (dB)				ME7848A-0271 ^a (dB)				ME7848A-0270 ^a (dB)			
	P1	P2	P3	P4	P1	P2	P3	P4	P1	P2	P3	P4
70 kHz to 300 kHz	± 2.6	± 2.6	± 2.9	± 4.1	± 2.2	± 2.3	± 2.7	± 4.0	± 2.2	± 2.3	± 3.6	± 4.0
> 300 kHz to 2 MHz	± 2.3	± 2.3	± 2.3	± 2.4	± 2.1	± 2.1	± 2.1	± 2.2	± 2.1	± 2.1	± 2.1	± 2.2
> 2 MHz to 10 MHz	± 2.1	± 2.1	± 2.1	± 2.1	± 1.8	± 1.9	± 1.9	± 1.9	± 1.8	± 1.8	± 1.8	± 1.8
> 0.01 to < 2.5	± 2.0	± 2.0	± 2.0	± 2.0	± 1.7	± 1.7	± 1.7	± 1.7	± 1.7	± 1.7	± 1.7	± 1.7
2.5 to 5	± 2.0	± 2.0	± 2.0	± 2.0	± 1.7	± 1.7	± 1.7	± 1.7	± 1.7	± 1.7	± 1.7	± 1.7
> 5 to 20	± 2.0	± 2.0	± 2.0	± 2.0	± 1.8	± 1.8	± 1.8	± 1.8	± 1.7	± 1.8	± 1.8	± 1.8
> 20 to 38/40 ^b	± 3.1	± 3.1	± 3.1	± 3.1	± 1.9	± 1.9	± 1.9	± 1.9	± 1.8	± 1.8	± 1.8	± 1.8
> 38 to 50	-	-	-	-	± 2.0	± 2.1	± 2.1	± 2.1	± 2.0	± 2.0	± 2.0	± 2.0
> 50 to 65	-	-	-	-	± 2.4	± 2.4	± 2.4	± 2.4	± 2.0	± 2.0	± 2.0	± 2.1
> 65 to 67	-	-	-	-	± 2.5	± 2.5	± 2.5	± 2.6	± 2.2	± 2.2	± 2.2	± 2.2
> 67 to 70	-	-	-	-	± 2.5	± 2.5	± 2.5	± 2.6	± 2.2	± 2.2	± 2.2	± 2.2

- a. For Option -0272, use the Option -0271 values for 1310 nm operation. Use the Option -0270 values for 1550 nm operation.
- b. 38 GHz applies for Option -027x systems; 40 GHz applies for the Option -0240 system.

- P1 received level -30 dBm (at low freq, η_{det} of 1.6 A/W for 110 GHz systems)
- P2 received level -40 dBm (at low freq, η_{det} of 0.5 A/W for 110 GHz systems)
- P3 received level -50 dBm (at low freq, η_{det} of 0.16 A/W for 110 GHz systems)
- P4 received level -60 dBm (at low freq, η_{det} of 0.05 A/W for 110 GHz systems)

Frequency (GHz)	ME7848A/E-0210 (dB)				ME7848A/E-0211 ^a (dB)			
	P1	P2	P3	P4	P1	P2	P3	P4
70 kHz to 300 kHz	± 2.2	± 2.3	± 2.6	± 4.0	± 3.0	± 3.1	± 3.4	± 4.8
> 300 kHz to 2 MHz	± 2.1	± 2.1	± 2.1	± 2.2	± 2.8	± 2.8	± 2.8	± 2.9
> 2 MHz to 10 MHz	± 2.0	± 2.0	± 2.0	± 2.0	± 2.5	± 2.5	± 2.5	± 2.5
> 0.01 to < 2.5	± 1.9	± 1.9	± 1.9	± 1.9	± 2.3	± 2.3	± 2.3	± 2.3
2.5 to 10	± 1.8	± 1.8	± 1.8	± 1.8	± 2.1	± 2.1	± 2.1	± 2.1
> 10 to 24	± 1.8	± 1.8	± 1.8	± 1.9	± 1.9	± 1.9	± 1.9	± 2.0
> 24 to 40	± 1.9	± 1.9	± 1.9	± 1.9	± 1.9	± 1.9	± 1.9	± 2.0
> 40 to 54	± 1.9	± 1.9	± 1.9	± 2.0	± 2.0	± 2.0	± 2.0	± 2.1
> 54 to 60	± 2.0	± 2.0	± 2.0	± 2.1	± 2.1	± 2.1	± 2.1	± 2.2
> 60 to 65	± 2.1	± 2.1	± 2.1	± 2.1	± 2.1	± 2.1	± 2.1	± 2.2
> 65 to 70	± 2.1	± 2.1	± 2.1	± 2.2	± 2.1	± 2.1	± 2.1	± 2.2
> 70 to 80	± 2.1	± 2.1	± 2.1	± 2.2	± 2.1	± 2.1	± 2.1	± 2.2
> 80 to 90	± 2.1	± 2.1	± 2.1	± 2.2	± 2.2	± 2.2	± 2.2	± 2.3
> 90 to 100	± 2.2	± 2.2	± 2.2	± 2.3	± 2.2	± 2.3	± 2.3	± 2.3
> 100 to 110	± 2.3	± 2.3	± 2.3	± 2.4	± 2.4	± 2.4	± 2.4	± 2.5

- a. Typical.

Note that absolute responsivity is not directly plotted on the instrument, but that calculation can be easily implemented using optical power, E/O responsivities, and the VectorStar equation editor.

O/O Measurements

Noise Floor for O/O measurements

Expressed in terms of dBm (RMS) in a 10 Hz IFBW (average values are typically 4-6 dB lower (more negative)). Based on maximum nominal optical power from modulator (+5 dBm (-0270), +2 dBm (-0271), +4 dBm (-0272), -3 dBm (-0240), or +3 dBm (-021x)) and derived from de-embedding both the absolute E/O and O/E responses. Interconnecting fiber loss (1 m) neglected. 1 m VNA cable loss is included. 'Normal' refers to the conventional VNA coupler configuration. 'Reversed' refers to the use of the loop access to reverse the orientation of the port 2 test couplers (requires changing front and rear panel access loop configuration). The table below assumes the presence of VNA Option 70 (70 kHz operation); otherwise the minimum frequency is 10 MHz.

Frequency (GHz)	ME7848A-0240 (dBm)				ME7848A-0271 ^a (dBm)				ME7848A-0270 ^a (dBm)			
	051 Normal	051 Reversed	062 Normal	062 Reversed	051 Normal	051 Reversed	062 Normal	062 Reversed	051 Normal	051 Reversed	062 Normal	062 Reversed
70 kHz to 300 kHz	-32	-42	-32	-42	-49	-59	-49	-59	-56	-66	-56	-66
> 300 kHz to 2 MHz	-37	-47	-37	-47	-54	-64	-54	-64	-61	-71	-61	-71
> 2 MHz to 10 MHz	-42	-52	-42	-52	-59	-69	-59	-69	-66	-76	-66	-76
> 0.01 to < 2.5	-50	-57	-50	-57	-69	-76	-69	-76	-76	-83	-76	-83
2.5 to 5	-52	-59	-52	-59	-69	-76	-69	-76	-76	-83	-76	-83
> 5 to 20	-47	-54	-47	-54	-65	-72	-65	-72	-72	-79	-72	-78
> 20 to 38/40 ^b	-32	-34	-32	-33	-62	-64	-62	-63	-69	-71	-69	-70
> 38 to 50	-	-	-	-	-54	-55	-53	-54	-61	-62	-60	-61
> 50 to 65	-	-	-	-	-49	-47	-47	-45	-56	-53	-53	-52
> 65 to 67	-	-	-	-	-46	-43	-43	-40	-53	-50	-50	-47
> 67 to 70	-	-	-	-	-41	-37	-38	-34	-48	-45	-44	-42

a. For Option -0272, use the Option -0271 values for 1310 nm operation. Use the Option -0270 values for 1550 nm operation.
 b. 38 GHz applies for Option -027x systems; 40 GHz applies for the Option -0240 system.

Frequency (GHz)	ME7848A/E-0210 (dBm)			ME7848A/E-0211 ^a (dBm)		
	000 Normal	051 Normal	062 Normal	000 Normal	051 Normal	062 Normal
70 kHz to 300 kHz	-45	-45	-45	-41	-41	-41
> 300 kHz to 2 MHz	-57	-57	-57	-53	-53	-53
> 2 MHz to 10 MHz	-71	-71	-71	-67	-67	-67
> 0.01 to < 2.5	-73	-73	-73	-69	-69	-69
2.5 to 10	-76	-75	-74	-72	-71	-70
> 10 to 24	-71	-69	-69	-68	-66	-66
> 24 to 40	-67	-66	-65	-64	-63	-62
> 40 to 54	-70	-69	-67	-67	-65	-63
> 54 to 60	-67	-67	-67	-63	-63	-63
> 60 to 65	-66	-66	-66	-63	-63	-63
> 65 to 70	-65	-65	-65	-62	-62	-62
> 70 to 80	-62	-62	-62	-59	-59	-59
> 80 to 90	-61	-61	-61	-57	-57	-57
> 90 to 100	-55	-55	-55	-51	-51	-51
> 100 to 110	-55	-55	-55	-51	-51	-51

a. Typical.

Frequency Response Repeatability for O/O Measurements

Typical and in dB terms, 10 Hz IFBW at various composite response levels (P1-P4) at the receiving VNA port (assumed normal (not reversed)), excludes fiber connector effects. The composite response is affected by the optical power level and DUT losses. Assumes nominal 90 minute warm-up. The table below assumes the presence of VNA Option 70 (70 kHz operation); otherwise the minimum frequency is 10 MHz.

- P1 received level -30 dBm
- P2 received level -40 dBm (corresponds to 0 dB optical loss at low RF frequencies for specified system responsivities, default RF power, and +5 dBm optical power for Option -0270 and +3 dBm for Option -0210)
- P3 received level -50 dBm (corresponds to 0 dB optical loss at low RF frequencies for specified system responsivities, default RF power, and +2 dBm optical power for Option -0271, -1 dBm optical power for Option -0240, and +3dBm optical power for Option -0211)
- P4 received level -60 dBm

Frequency (GHz)	ME7848A-0240 (dB)				ME7848A-0271 ^a (dB)				ME7848A-0270 ^a (dB)			
	P1	P2	P3	P4	P1	P2	P3	P4	P1	P2	P3	P4
70 kHz to 300 kHz	± 0.07	± 0.1	± 0.15	± 0.2	± 0.07	± 0.1	± 0.15	± 0.2	± 0.07	± 0.1 ^b	± 0.15	± 0.2
> 300 kHz to 2 MHz	± 0.05	± 0.07	± 0.1	± 0.15	± 0.05	± 0.07	± 0.1	± 0.15	± 0.05	± 0.07	± 0.1	± 0.15
> 2 MHz to 10 MHz	± 0.05	± 0.05	± 0.05	± 0.07	± 0.05	± 0.05	± 0.05	± 0.05	± 0.03	± 0.03	± 0.03	± 0.03
> 0.01 to < 2.5	± 0.05	± 0.05	± 0.05	± 0.07	± 0.05	± 0.05	± 0.05	± 0.05	± 0.03	± 0.03	± 0.03	± 0.03
> 2.5 to 5	± 0.03	± 0.05	± 0.05	± 0.05	± 0.05	± 0.05	± 0.05	± 0.05	± 0.03	± 0.03	± 0.03	± 0.03
> 5 to 20	± 0.03	± 0.05	± 0.05	± 0.05	± 0.05	± 0.05	± 0.05	± 0.05	± 0.03	± 0.03	± 0.03	± 0.03
> 20 to 38/40 ^c	± 0.05	± 0.07	± 0.07	± 0.09	± 0.05	± 0.05	± 0.05	± 0.05	± 0.03	± 0.05	± 0.05	± 0.05
> 38 to 50	-	-	-	-	± 0.05	± 0.05	± 0.05	± 0.05	± 0.03	± 0.05	± 0.05	± 0.05
> 50 to 65	-	-	-	-	± 0.05	± 0.05	± 0.05	± 0.05	± 0.05	± 0.05	± 0.05	± 0.05
> 65 to 67	-	-	-	-	± 0.05	± 0.05	± 0.05	± 0.07	± 0.05	± 0.05	± 0.05	± 0.05
> 67 to 70	-	-	-	-	± 0.07	± 0.07	± 0.07	± 0.1	± 0.07	± 0.07	± 0.07	± 0.07

a. For Option -0272, use the -0271 values for 1310 nm operation. Use the Option -0270 values for 1550 nm operation except where noted.

b. For Option -0272, use ± 0.12.

c. 38 GHz applies for Option -027x systems; 40 GHz applies for the Option -0240 system.

- P1 received level -30 dBm
- P2 received level -40 dBm (corresponds to 0 dB optical loss at low RF frequencies for specified system responsivities at 1550 nm, default RF power, and +3 dBm optical power for 110 GHz systems)
- P3 received level -50 dBm
- P4 received level -60 dBm

Frequency (GHz)	ME7848A/E-0210 (dB)				ME7848A/E-0211 (dB)			
	P1	P2	P3	P4	P1	P2	P3	P4
70 kHz to 300 kHz	± 0.07	± 0.10	± 0.15	± 0.20	± 0.10	± 0.15	± 0.20	± 0.25
> 300 kHz to 2 MHz	± 0.05	± 0.07	± 0.10	± 0.15	± 0.10	± 0.10	± 0.15	± 0.20
> 2 MHz to 10 MHz	± 0.03	± 0.03	± 0.03	± 0.03	± 0.07	± 0.07	± 0.07	± 0.07
> 0.01 to < 2.5	± 0.03	± 0.03	± 0.03	± 0.03	± 0.07	± 0.07	± 0.07	± 0.07
2.5 to 10	± 0.03	± 0.03	± 0.03	± 0.03	± 0.03	± 0.03	± 0.03	± 0.05
> 10 to 24	± 0.05	± 0.05	± 0.05	± 0.05	± 0.05	± 0.05	± 0.05	± 0.05
> 24 to 40	± 0.05	± 0.05	± 0.05	± 0.05	± 0.05	± 0.05	± 0.05	± 0.05
> 40 to 54	± 0.05	± 0.05	± 0.05	± 0.05	± 0.05	± 0.05	± 0.05	± 0.06
> 54 to 60	± 0.05	± 0.05	± 0.05	± 0.06	± 0.05	± 0.05	± 0.07	± 0.08
> 60 to 65	± 0.05	± 0.05	± 0.06	± 0.06	± 0.05	± 0.05	± 0.07	± 0.08
> 65 to 70	± 0.06	± 0.06	± 0.06	± 0.07	± 0.07	± 0.07	± 0.07	± 0.10
> 70 to 80	± 0.06	± 0.06	± 0.06	± 0.07	± 0.07	± 0.07	± 0.10	± 0.10
> 80 to 90	± 0.06	± 0.06	± 0.07	± 0.08	± 0.07	± 0.10	± 0.10	± 0.10
> 90 to 100	± 0.07	± 0.07	± 0.08	± 0.10	± 0.10	± 0.10	± 0.10	± 0.12
> 100 to 110	± 0.08	± 0.08	± 0.08	± 0.10	± 0.10	± 0.12	± 0.12	± 0.15

Frequency Response Uncertainty for O/O Measurements

Includes residual VNA calibration errors, electrical mismatch uncertainties, noise floor effects, characterization uncertainties, and repeatability based on sequential de-embedding of OE and EO responses (see next tables for simple normalization-based uncertainties). A full two-port calibration (using a 3654D calibration kit for the Option -027x systems, a 3652A calibration kit for the Option -0240 system, or a 3656C calibration kit for the Option -021x systems) is assumed and DUT (optical) mismatch is ignored. 10 Hz IFBW is assumed and drive power is assumed low enough that linearity issues are not present. Uncertainties are on a 95% basis and are in single-sided dB terms and indexed to the power received by the VNA. The table below assumes the presence of VNA Option 70 (70 kHz operation); otherwise the minimum frequency is 10 MHz.

- P1 received level -30 dBm
- P2 received level -40 dBm (corresponds to 0 dB optical loss at low RF frequencies for specified system responsivities, default RF power, and +5 dBm optical power for Option -0270)
- P3 received level -50 dBm (corresponds to 0 dB optical loss at low RF frequencies for specified system responsivities, default RF power, and +2 dBm optical power for Option -0271, and -1 dBm optical power for Option -0240)
- P4 received level -60 dBm

Frequency (GHz)	ME7848A-0240 (dB)				ME7848A-0271 ^a (dB)				ME7848A-0270 ^a (dB)			
	P1	P2	P3	P4	P1	P2	P3	P4	P1	P2	P3	P4
70 kHz to 300 kHz	± 2.6	± 2.6	± 2.8	± 4.1	± 0.7	± 0.8	± 1.3	± 3.0	± 0.7	± 0.8 ^b	± 1.3	± 3.0
> 300 kHz to 2 MHz	± 1.7	± 1.7	± 1.7	± 1.8	± 0.6	± 0.7	± 0.7	± 0.9	± 0.6	± 0.6	± 0.7	± 0.9
> 2 MHz to 10 MHz	± 1.4	± 1.4	± 1.4	± 1.4	± 0.5	± 0.5	± 0.5	± 0.6	± 0.5	± 0.5	± 0.5	± 0.6
> 0.01 to < 2.5	± 1.0	± 1.0	± 1.0	± 1.0	± 0.5	± 0.5	± 0.5	± 0.5	± 0.3	± 0.3	± 0.3	± 0.3
2.5 to 5	± 0.8	± 0.8	± 0.9	± 0.9	± 0.5	± 0.5	± 0.5	± 0.5	± 0.3	± 0.3	± 0.3	± 0.3
> 5 to 20	± 0.8	± 0.8	± 0.9	± 0.9	± 0.5	± 0.5	± 0.5	± 0.4	± 0.3	± 0.3	± 0.3	± 0.4
> 20 to 38/40 ^c	± 3.7	± 3.7	± 3.8	± 3.8	± 0.5	± 0.5	± 0.5	± 0.5	± 0.4	± 0.4	± 0.4	± 0.4
> 38 to 50	-	-	-	-	± 0.7	± 0.7	± 0.7	± 0.7	± 0.6	± 0.6	± 0.6	± 0.6
> 50 to 65	-	-	-	-	± 1.0	± 1.0	± 1.1	± 1.1	± 0.6	± 0.6	± 0.6	± 0.7
> 65 to 67	-	-	-	-	± 1.0	± 1.0	± 1.1	± 1.1	± 0.7	± 0.7	± 0.7	± 0.8
> 67 to 70	-	-	-	-	± 1.0	± 1.0	± 1.1	± 1.1	± 0.8	± 0.8	± 0.8	± 0.9

a. For Option -0272, use the Option -0271 values for 1310 nm operation. Use the Option -0270 values for 1550 nm operation, except where noted.

b. For Option -0272, use 1.0.

c. 38 GHz applies for Option -027x systems; 40 GHz applies for the Option -0240 system.

- P1 received level -30 dBm
- P2 received level -40 dBm (corresponds to 0 dB optical loss at low RF frequencies for specified system responsivities at 1550 nm, default RF power, and +3 dBm optical power for 110 GHz systems)
- P3 received level -50 dBm
- P4 received level -60 dBm

Frequency (GHz)	ME7848A/E-0210 (dB)				ME7848A/E-0211 ^a (dB)			
	P1	P2	P3	P4	P1	P2	P3	P4
70 kHz to 300 kHz	± 0.8	± 1.0	± 1.3	± 3.0	± 1.6	± 1.8	± 2.1	± 3.8
> 300 kHz to 2 MHz	± 0.7	± 0.7	± 0.7	± 0.9	± 1.3	± 1.3	± 1.3	± 1.5
> 2 MHz to 10 MHz	± 0.5	± 0.5	± 0.5	± 0.6	± 1.0	± 1.0	± 1.0	± 1.0
> 0.01 to < 2.5	± 0.5	± 0.5	± 0.5	± 0.5	± 0.9	± 0.9	± 0.9	± 0.9
2.5 to 10	± 0.4	± 0.4	± 0.4	± 0.5	± 0.7	± 0.7	± 0.7	± 0.8
> 10 to 24	± 0.4	± 0.4	± 0.4	± 0.5	± 0.5	± 0.5	± 0.5	± 0.5
> 24 to 40	± 0.4	± 0.4	± 0.4	± 0.5	± 0.4	± 0.4	± 0.4	± 0.5
> 40 to 54	± 0.4	± 0.4	± 0.4	± 0.5	± 0.4	± 0.4	± 0.5	± 0.5
> 54 to 60	± 0.4	± 0.4	± 0.5	± 0.5	± 0.5	± 0.5	± 0.5	± 0.5
> 60 to 65	± 0.6	± 0.6	± 0.6	± 0.7	± 0.6	± 0.6	± 0.6	± 0.7
> 65 to 70	± 0.7	± 0.7	± 0.7	± 0.7	± 0.7	± 0.7	± 0.7	± 0.7
> 70 to 80	± 0.7	± 0.7	± 0.7	± 0.8	± 0.7	± 0.7	± 0.7	± 0.8
> 80 to 90	± 0.7	± 0.7	± 0.7	± 0.8	± 0.8	± 0.8	± 0.8	± 0.9
> 90 to 100	± 0.9	± 0.9	± 0.9	± 0.9	± 1.0	± 1.0	± 1.0	± 1.0
> 100 to 110	± 1.0	± 1.0	± 1.0	± 1.1	± 1.1	± 1.1	± 1.1	± 1.2

a. Typical.

Curves showing the uncertainty relationships in more detail are below. The optical power, insertion loss of the DUT, responsivity of the ME7848A/E system and any RF networks in the setup (e.g., cables and probes) will determine the x-axis value.

Normalization-based Frequency Response Uncertainty for O/O Measurements

Includes noise floor effects, repeatability and a nominal allowance for an optical reconnection (presumes all connectors cleaned and in good condition as in other tables). DUT (optical) mismatch is ignored. 10 Hz IFBW is assumed and drive power is assumed low enough that linearity issues are not present. Uncertainties are on a 95% basis and are in single-sided dB terms and indexed to the power received by the VNA. The table below assumes the presence of VNA Option 70 (70 kHz operation); otherwise the minimum frequency is 10 MHz.

- P1 received level -30 dBm
- P2 received level -40 dBm (corresponds to 0 dB optical loss at low RF frequencies for specified system responsivities, default RF power, and +5 dBm optical power for Option -0270 and +3 dBm optical power for Option -0210)
- P3 received level -50 dBm (corresponds to 0 dB optical loss at low RF frequencies for specified system responsivities, default RF power, and +2 dBm optical power for Option -0271, -1 dBm optical power for Option -0240, and +3 dBm optical power for Option -0211)
- P4 received level 60 dBm

Frequency (GHz)	ME7848A-0240 (dB)				ME7848A-0271 (dB)				ME7848A-0270 (dB)			
	P1	P2	P3	P4	P1	P2	P3	P4	P1	P2	P3	P4
70 kHz to 300 kHz	± 0.3	± 0.3	± 0.4	± 0.5	± 0.3	± 0.3	± 0.4	± 0.4	± 0.3	± 0.3	± 0.4	± 0.4
> 300 kHz to 2 MHz	± 0.3	± 0.3	± 0.3	± 0.4	± 0.3	± 0.3	± 0.3	± 0.4	± 0.3	± 0.3	± 0.3	± 0.4
> 2 MHz to 10 MHz	± 0.2	± 0.2	± 0.2	± 0.2	± 0.5	± 0.5	± 0.5	± 0.6	± 0.5	± 0.5	± 0.5	± 0.6
> 0.01 to < 2.5	± 0.2	± 0.2	± 0.2	± 0.2	± 0.2	± 0.2	± 0.2	± 0.2	± 0.2	± 0.2	± 0.2	± 0.2
2.5 to 5	± 0.2	± 0.2	± 0.2	± 0.2	± 0.2	± 0.2	± 0.2	± 0.2	± 0.2	± 0.2	± 0.2	± 0.2
> 5 to 20	± 0.2	± 0.2	± 0.2	± 0.3	± 0.2	± 0.2	± 0.2	± 0.2	± 0.2	± 0.2	± 0.2	± 0.2
> 20 to 38/40	± 0.3	± 0.3	± 0.4	± 0.4	± 0.2	± 0.2	± 0.2	± 0.2	± 0.2	± 0.2	± 0.2	± 0.2
> 38 to 50	-	-	-	-	± 0.2	± 0.2	± 0.2	± 0.2	± 0.2	± 0.2	± 0.2	± 0.2
> 50 to 65	-	-	-	-	± 0.2	± 0.2	± 0.2	± 0.2	± 0.2	± 0.2	± 0.2	± 0.2
> 65 to 67	-	-	-	-	± 0.2	± 0.2	± 0.2	± 0.3	± 0.2	± 0.2	± 0.2	± 0.3
> 67 to 70	-	-	-	-	± 0.2	± 0.2	± 0.3	± 0.3	± 0.2	± 0.2	± 0.3	± 0.3

- P1 received level -30 dBm
- P2 received level -40 dBm (corresponds to 0 dB optical loss at low RF frequencies for specified system responsivities at 1550 nm, default RF power, and +3 dBm optical power for 110 GHz systems)
- P3 received level -50 dBm
- P4 received level -60 dBm

Frequency (GHz)	ME7848A/E-0210 (dB)				ME7848A/E-0211 (dB)			
	P1	P2	P3	P4	P1	P2	P3	P4
70 kHz to 300 kHz	± 0.3	± 0.3	± 0.4	± 0.5	± 0.3	± 0.3	± 0.4	± 0.5
> 300 kHz to 2 MHz	± 0.3	± 0.3	± 0.3	± 0.4	± 0.3	± 0.3	± 0.3	± 0.4
> 2 MHz to 10 MHz	± 0.2	± 0.2	± 0.2	± 0.2	± 0.2	± 0.2	± 0.2	± 0.2
> 0.01 to < 2.5	± 0.2	± 0.2	± 0.2	± 0.2	± 0.2	± 0.2	± 0.2	± 0.2
2.5 to 10	± 0.2	± 0.2	± 0.2	± 0.2	± 0.2	± 0.2	± 0.2	± 0.2
> 10 to 24	± 0.2	± 0.2	± 0.2	± 0.2	± 0.2	± 0.2	± 0.2	± 0.2
> 24 to 40	± 0.2	± 0.2	± 0.2	± 0.2	± 0.2	± 0.2	± 0.2	± 0.2
> 40 to 54	± 0.2	± 0.2	± 0.2	± 0.2	± 0.2	± 0.2	± 0.2	± 0.2
> 54 to 60	± 0.2	± 0.2	± 0.2	± 0.2	± 0.2	± 0.2	± 0.2	± 0.2
> 60 to 65	± 0.2	± 0.2	± 0.2	± 0.2	± 0.2	± 0.2	± 0.2	± 0.2
> 65 to 70	± 0.2	± 0.2	± 0.2	± 0.2	± 0.2	± 0.2	± 0.2	± 0.2
> 70 to 80	± 0.2	± 0.2	± 0.2	± 0.2	± 0.2	± 0.2	± 0.2	± 0.2
> 80 to 90	± 0.2	± 0.2	± 0.2	± 0.2	± 0.2	± 0.2	± 0.2	± 0.2
> 90 to 100	± 0.2	± 0.2	± 0.2	± 0.3	± 0.2	± 0.2	± 0.2	± 0.3
> 100 to 110	± 0.2	± 0.2	± 0.2	± 0.3	± 0.2	± 0.2	± 0.2	± 0.3

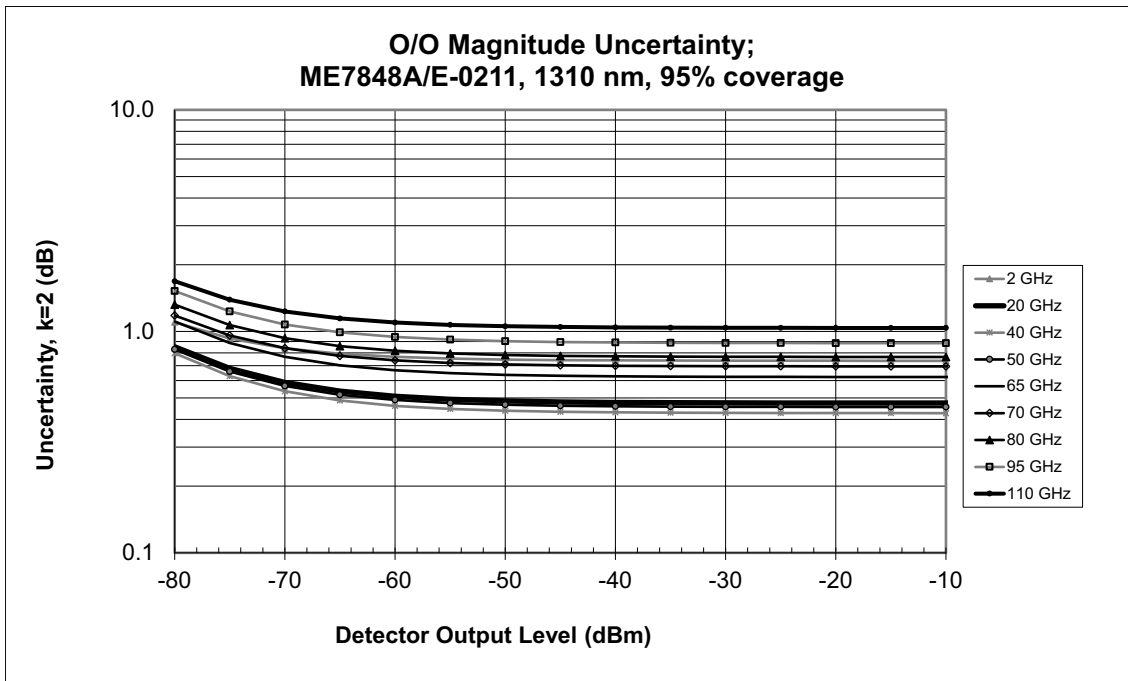
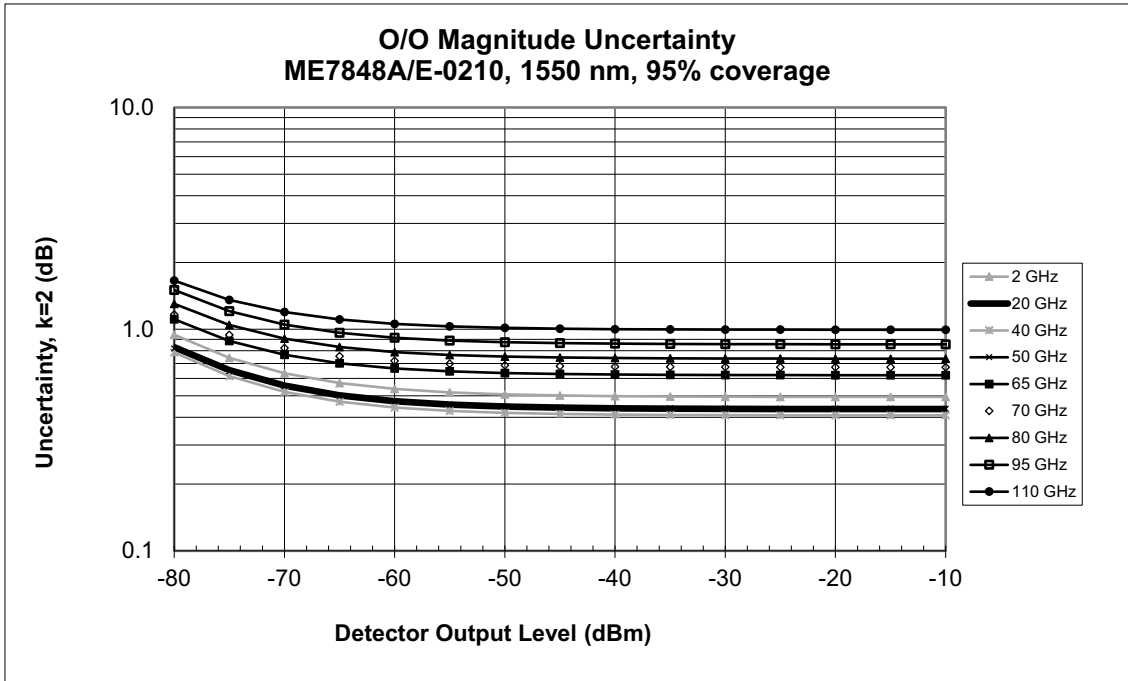

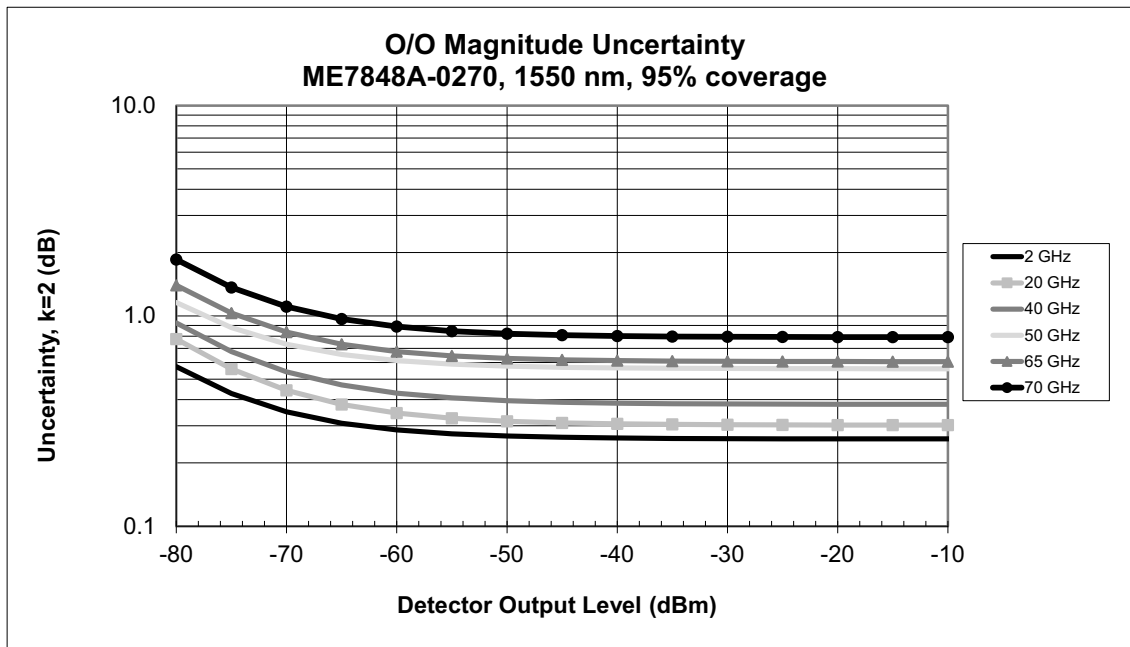
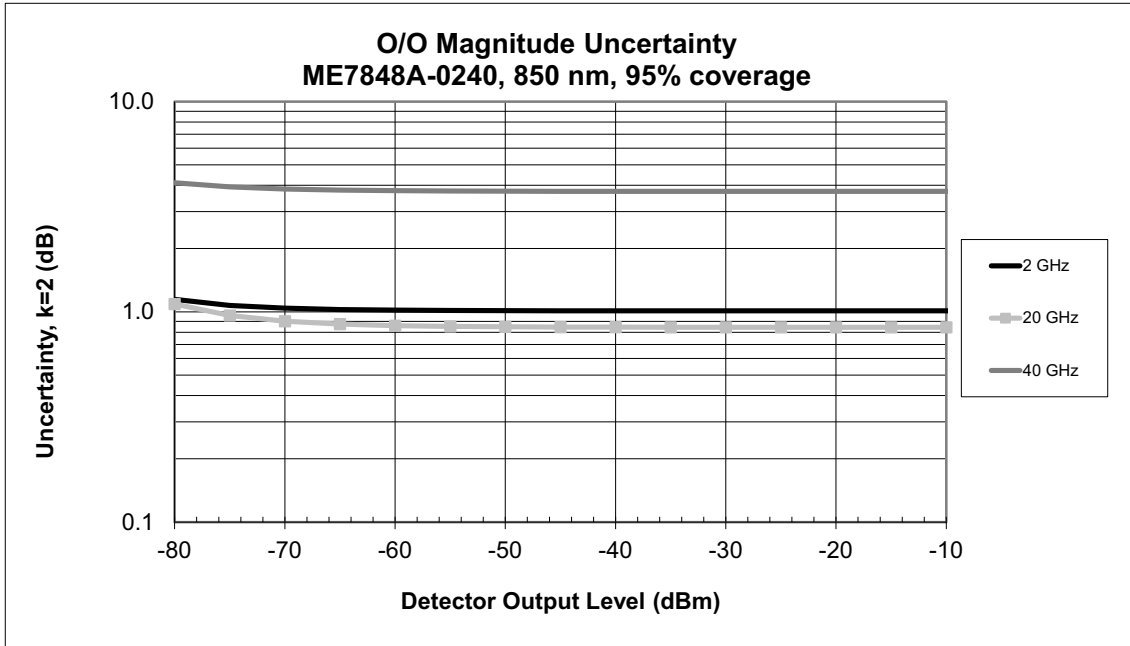

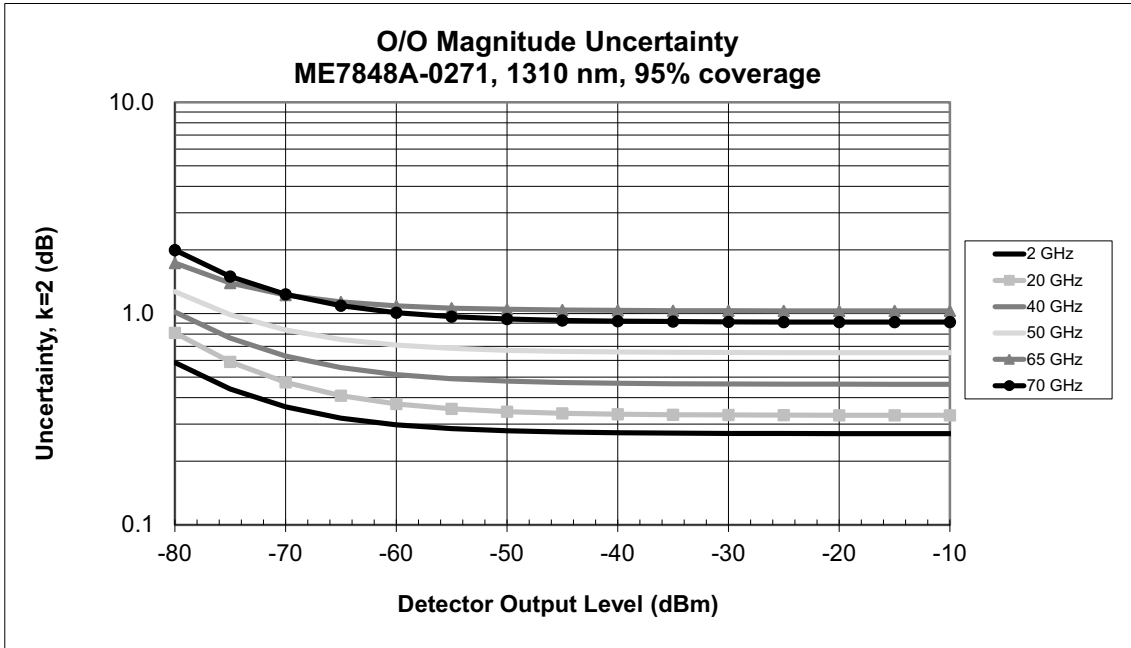

Optical Power Measurement

Average optical power measurements are possible with the ME7848 systems when used with an external or internal bias tee.

Nominal measurement range: -25 dBm to +6 dBm (+2 dBm maximum for -0240).

Typical average uncertainty: ± 0.5 dB (dependent on system averaging and bandwidth settings and responsivity value entry for the MN4765B).

Example Plots

Example plots of the response dependence on optical power are shown below for the ME7848A-0271 (1310 nm) system. Transmission ($|S_{21}|$) is shown first with an RF drive of -10 dBm (default power for the 70 GHz systems) and 10 Hz IF bandwidth. This measurement is of the integral E/O and O/E modules (and internal laser) connected by a 1m patch cable and with a 1m RF cable from the VNA to the E/O input. The O/E output is connected directly to port 2 of the VNA in its normal (not reversed) configuration. A full 2-port calibration is applied but no de-embedding has been performed (of either the O/E or E/O components). The specified VNA noise floor for this bandwidth and power level is also shown.

Higher RF power levels are possible (native and with external amplification) as long as compression limits are observed. When user E/O and O/E devices are inserted, the responses may go up or down from these plots depending on the relative responsivities. In an O/O measurement, optical loss will shift the curves lower. The curves for ME7848A-0270 systems are nominally 4 dB higher due to the higher detector responsivity and higher optical powers available in those systems. ME7848A-0240 systems will have curves generally 6-7 dB lower (lower responsivity) to 40 GHz.

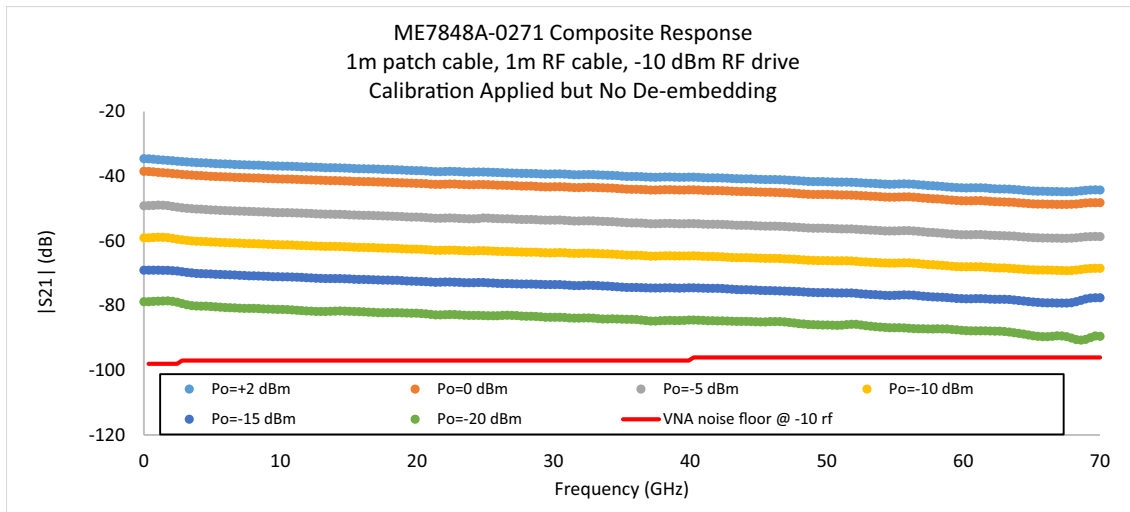

The absolute O/E output power is plotted below for the same setup. This measurement is achieved by first performing an RF power calibration and a receiver calibration at port 2 (for the b2 receiver).

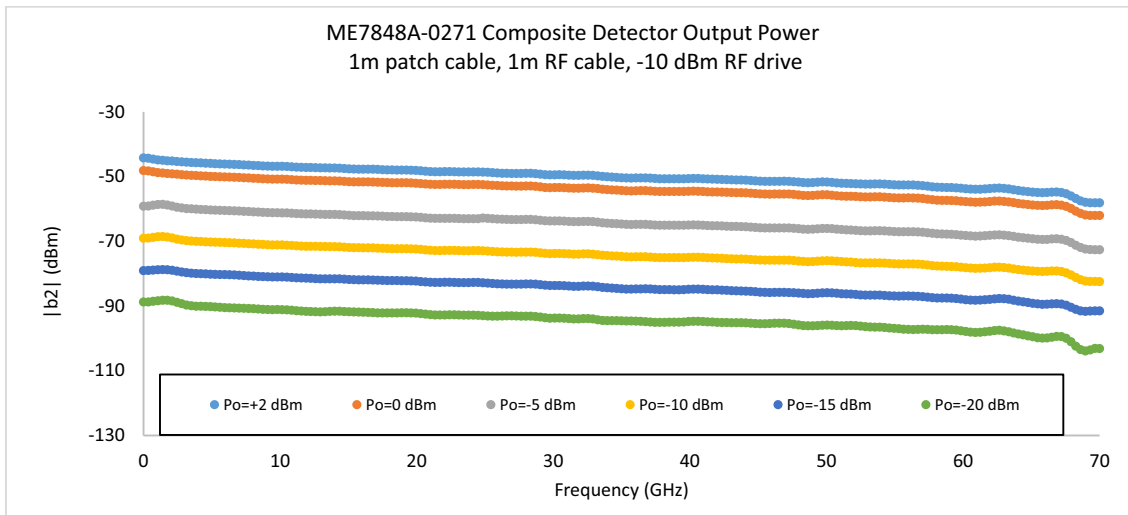

An example stability plot of the composite response over 24 hours is shown below. This will include effects of optical power drift, cable drift, VNA drift and optical converter drift as the temperature varied approximately $\pm 3C$ over this period of time. Optical power was set for +2 dBm, RF power was -10 dBm, and the IF bandwidth was 100 Hz.

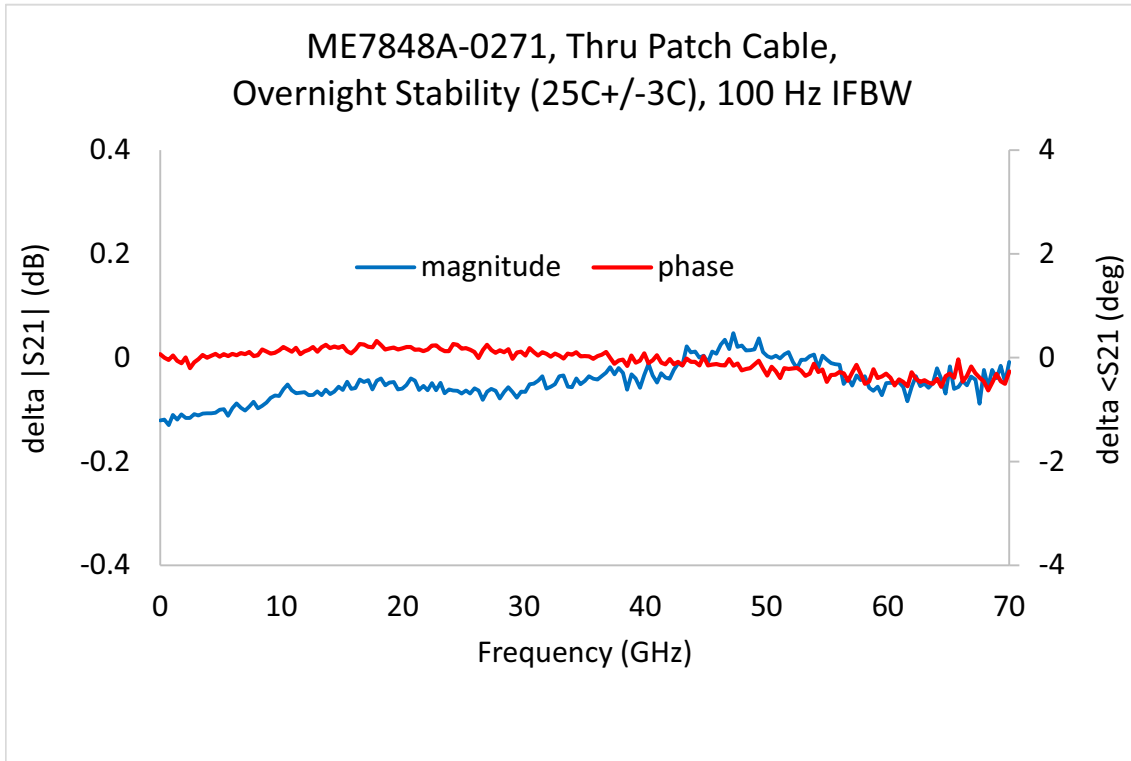

Examples responses of a multimode E/O device are shown below when measured with a ME7848A-240 system and with a native multimode photodetector (limited to 30 GHz bandwidth). The latter will have higher absolute detector output since it avoids the multimode-single mode transition but there are stability differences. These normalized plots show the reported responses are quite similar. There are some differences in signal-to-noise ratio in the high attenuation zones. The differences can be mitigated with lower IF bandwidths.

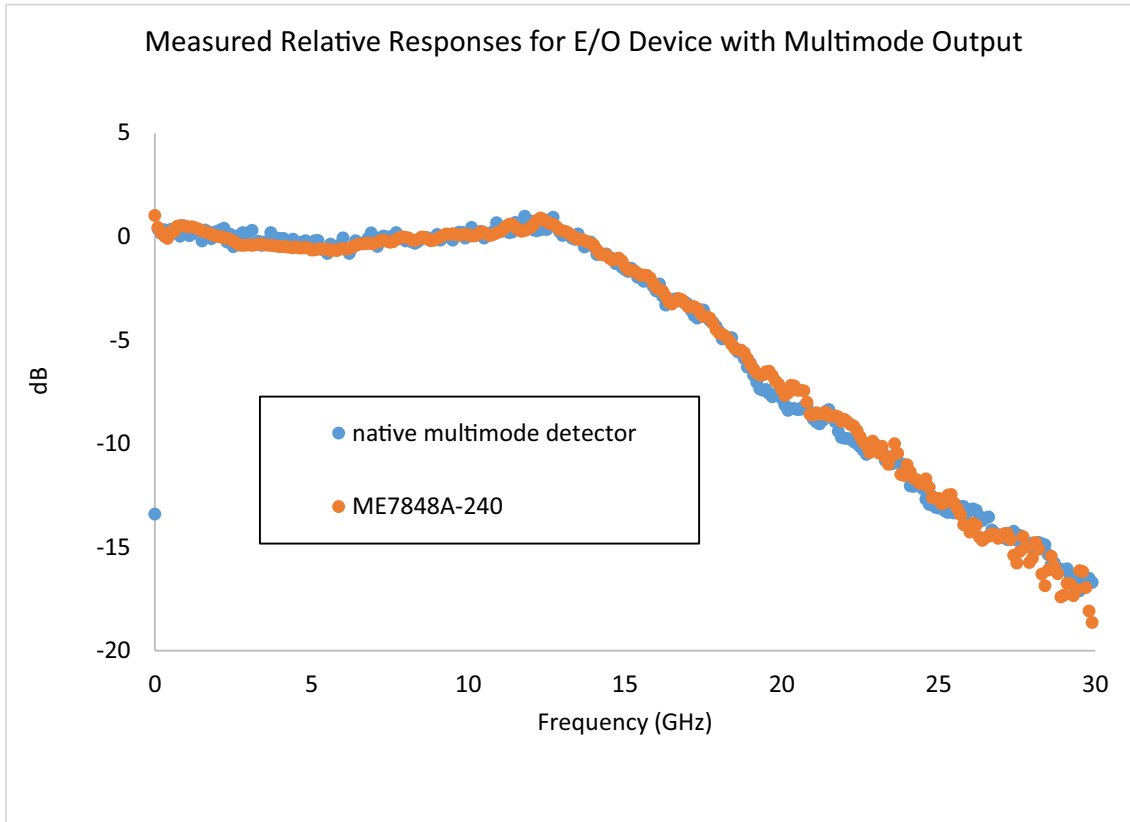

Standard Capabilities

Operating Frequency

ME7848A-021x
(Uses the ME7838AX broadband VNA system) 10 MHz to 110 GHz

ME7848E-021x
(Uses the ME7838EX broadband VNA system) 10 MHz to 110 GHz
ME7848A-0240 (uses the MS4644B VNA) 10 MHz to 40.5 GHz
ME7848A-027x (uses the MS4647B VNA) 10 MHz to 70 GHz

MS4640B-070 Optional for MS4640B series VNAs. Provides 40 kHz to 10 MHz Coverage Extension. Provides a lower limit specified to 70 kHz, which is allowed to extend to 40 kHz.

Measurement Parameters

2-Port Measurements S_{11} , S_{21} , S_{22} , S_{12} , and any user-defined combination of a_1 , a_2 , b_1 , b_2 , and 1.

4-Port Measurements Refer to the separate VectorStar MN469xC Series Multiport VNA Measurement System Technical Data Sheet 11410-00777, available at <http://www.anritsu.com/en-US/test-measurement/products/ms4640b-series>

Domains Frequency Domain, Power Domain, CW Draw, and Time (Distance) Domain

Sweeps

Frequency Sweep Types Linear, Log, CW, or Segmented

Power Sweep Types Linear, constant power sweeps, or constant power slope (dB/GHz) over frequency sweep

Display Graphs

Single Rectilinear Graph Types Log Magnitude, Phase, Group Delay, Linear Magnitude, Real, Imaginary, Inductance, Capacitance, SWR, Power Out, Impedance, and Power In

Dual Rectilinear Graph Types Log Magnitude and Phase, Linear Magnitude and Phase, and Real and Imaginary

Circular Graph Types Smith Chart (Impedance), Smith Chart (Admittance), Linear Polar, and Log Polar

Measurements Data Points

25,000 Data Points 2 to 25,000 points in up to 16 channels

100,000 Data Points 2 to 100,000 points in single channel

Limit Lines		
Limit Lines	Single or segmented. 2 limit lines per trace. 50 segments per limit line.	
Single Limit Readouts	Uses interpolation to determine the intersection frequency.	
Test Limits	Both single and segmented limits can be used for PASS/FAIL testing.	
Averaging		
Point-by-Point	Point-by-point (default), max Averaging = IF Bandwidth/1 Hz	
Sweep-by-Sweep	Sweep-by-sweep (no limit)	
IF Bandwidth		1, 2, 3, 5, 7, 10, 20, 30, 50, 70, 100, 200, 300, 500, 700 Hz; 1, 2, 3, 5, 7, 10, 20, 30, 50, 70, 100, 200, 300, 500, 700 kHz; 1MHz
Reference Plane		
Line Length or Time Delay	The reference planes of a calibration or other normalization can be changed by entering a line length or time delay.	
Dielectric Constants	Dielectric constants may be entered for different media so the length entry can be physically meaningful.	
Dispersion Modeling	Dispersion modeling is used in the cases of microstrip and waveguide to take into account frequency dependent phase velocities.	
Attenuation	Attenuation (with frequency slope) and constant phase offsets can be entered to better describe any reference plane distortions. The frequency dependence exponent is changeable.	
Auto Modes	Automatic reference plane finding tools are available for phase alone or phase + magnitude. These routines do a fitting process on phase or phase and magnitude to estimate the reference plane location and enter correcting values.	
De-embedding	For more complete reference plane manipulation, the full de-embedding system can also be used.	
Measurement Frequency Range		
Frequency Range Change	Frequency range of the measurement can be narrowed within the calibration range without recalibration.	
CW Mode	CW mode permits single frequency measurements also without recalibration.	
Interpolation Not Activated	If interpolation is not activated, the subset frequency range is forced to use calibration frequency points.	
Interpolation Activated	If interpolation is activated, any frequency range that is a subset of the calibration frequency range can be used, but there may be some added interpolation error.	
Group Delay		
Group Delay Aperture	Defined as the frequency span over which the phase change is computed at a given frequency point.	
Aperture	The aperture can be changed without recalibration.	
Minimum Aperture	The minimum aperture is the frequency range divided by the number of points in calibration and can be increased to 20% of the frequency range.	
Group Delay Range	< 180° of phase change within the aperture	
Channels, Display, and Traces		
Channels and Traces	16 channels, each with up to 16 traces	
Display	Color touch screen LCD, 26.4 cm (10.4") diagonal	
Display Colors	Unlimited colors for data traces, memory, text, markers, graticules and limit lines.	
Trace Memory and Math	A separate memory for each trace can be used to store measurement data for later display or subtraction, addition, multiplication or division with current measurement data. The trace data can be saved and recalled.	
Inter-trace Math	Any two traces within a channel can also be combined (via addition, subtraction, multiplication or division) and displayed on another trace. An equation editor mode is also available that allows the combination of trace data, trace memory and S-parameter data in more complex equations. Over 30 built-in functions are available. Simple editing tools and the ability to save/recall equations are also provided.	
Scale Resolution		Minimum per division, varies with graph type.
Log Magnitude	0.001 dB	
Linear Magnitude	1 μ	
Inductance	1 fH	
Capacitance	1 fF	
Phase	0.01°	
Group Delay	0.001 ps	
Time	0.001 ps	
Distance	0.1 μ m	
SWR	1 μ	
Power	0.01 dB	

Markers

Markers	12 markers per trace (x 16 traces x 16 channels, for a total of 3,072)
Marker Coupling	Coupled or decoupled within a channel
Marker Data	Data displayed in graph area or in table form
Reference Marker	Additional marker per trace for reference
Marker Statistics	Mean, maximum, minimum, standard deviation Per trace or over a marker region.
Marker Search and Tracking	Search and/or track for minimum, maximum, peak, or target value.

Other

Filter Parameters	Display bandwidth (user-selectable loss value), corner and center frequencies, loss, Q, and shape factors.
Blank Frequency Information	Blanking function removes all references to frequencies on the display. Frequency references can only be restored through a system preset or GPIB command.

Saving Data

.sNp	<i>(Where N=1 or 2 for two port systems, and N=1 to 4 for four port systems)</i> The traditional Touchstone® file format for loading into simulators and other tools. Tools are available for re-assigning ports and selecting the units (Hz to GHz for frequency; linear magnitude-and-phase, real-and-imaginary or log magnitude-and-phase for data; these units are listed in the file header). Selections are available to put the outputs of frequency-with-time-gating (part of Option 2), or trace math in lieu of just the calibrated S-parameter. It is also possible to enforce passivity or causality on the parameters saved in these files. Only those parameters indicated by the file extension will be saved.
.mNp	<i>(Where N=2 for two port systems, and N= 2 or 4 for four port systems)</i> This is the mixed-mode version of the Touchstone® format with mixed-mode parameters substituted for the single-ended S-parameters. Differential and common-mode port pair assignments can be changed.
.txt and .csv	These are the familiar tab-delimited and comma-delimited file formats often used in spreadsheets. All traces in the current channel will be saved using whatever trace formats are currently enabled. Frequency and time domain traces will be saved in the same file and each trace will be saved with its own frequency/time vector. An extensive header in these files denotes instrument settings.
.bmp, .png, and .jpg	These are the familiar graphics files formats. The graph area, the marker table (if active), the segmented sweep, limit line or multiple source tables (if active) and the bottom status bar are saved as part of the image. The top and side menu bars are not saved.
.tdf and .tdu	These are internal trace data formats (formatted data using the current graph type or unformatted) that can be used to recall data into trace memory at a later time.

Remote Operability

VectorStar supports several remote operability options.

Communication Type	Data Format	Performance	Description
Via GPIB	Using IEEE 488.2	1 MB/s Data Transfer Speed	Use SCPI or previous generation Lightning VNA commands. Also compatible with a fundamental set of HP/Agilent 8510x VNA commands.
Via LAN	Using VXI-11 Protocol	2.5 MB/s Data Transfer Speed	
Via USB	Using USBTMC Protocol	5.5 MB/s Data Transfer Speed	
Drivers for GPIB, LAN, or USB	National Instruments LabVIEW and LabWindows/CVI drivers are available for download from both the Anritsu and National Instruments web sites. .NET/COM driver for Windows® Applications such as Visual Studio 6 thru VS 2005, VB6, C#, C++, C, Visual C, HP Vee, and more are available for download from the Anritsu web site. These drivers require VISA runtime, not provided by Anritsu. NI VISA version 3.2 or higher is recommended for .NET and USB support.		
Triggering	Internal, External, GPIB Single point, Single Sweep, and Single Channel. All Channels are hand-shaking for optimum tandem sweeps (check rear panel connections).		

Calibration and Correction Capabilities

Calibration Methods	<p>Short-Open-Load-Through (SOLT) with Fixed or Sliding Load and supporting .s1p-defined cal kits Offset-Short-Offset-Short-Load-Through (SSLT) with Fixed or Sliding Load Triple-Offset-Short-Through (SSST) and overdetermined offset short (mSSST) Short-Open-Load-Reciprocal (SOLR) or Unknown Through Method (SSLR, SSSR) Thru-Reflect-Line (TRL) – (up to 5 bands supported) Line-Reflect-Line (LRL) / Line-Reflect-Match (LRM) – (up to 5 bands supported for multi-line configurations) Advanced-LRM (A-LRM™) for improved on-wafer calibrations Multiline Through-Reflect-Line (mTRL) Hybrid cal (allows combination of sub-cals of different types or media) AutoCal™ Thru Update available Secondary match correction available for improved low insertion loss measurements</p>
Correction Models	<p>2-Port (Forward, Reverse, or both directions) 1-Port (S₁₁, S₂₂, or both) Transmission Frequency Response (Forward, Reverse, or both directions) Reflection Frequency Response (S₁₁, S₂₂, or both)</p>
Merged Calibration	<p>Merge multiple calibrations over bands of frequency points and with different algorithms</p>
Coefficients for Calibration Standards	<p>Use the Anritsu calibration kit USB Memory Device to load kit coefficients and characterization files. Enter manual coefficients into user-defined locations. Complex load models are available. Full .s1p definitions of calibration standards can be loaded.</p>
Reference Impedance	<p>Modify the reference impedance from 50 Ω to any impedance greater than 0 Ω.</p>
Interpolation	<p>Allows interpolation between calibration frequency points. Accuracy will be reduced at non-calibration frequencies and that degradation is dependent on the frequency step size in the initial calibration and the electrical length of the user's setup.</p>
Adapter Removal Calibration	<p>Characterizes and “removes” an adapter that is used during calibration that will not be used for subsequent device measurements; for accurate measurement of non-insertable devices.</p>
Dispersion Compensation	<p>Selectable as Coaxial, other non-dispersive (e.g., for coplanar waveguide), Waveguide, or Microstrip.</p>
Power	<p>Power Meter Correction Different power meter calibrations are available to enhance power accuracy at the desired reference plane. The source power will match the target calibration power, as read by the power meter, to within ~0.1 dB for short periods of time (determined by thermal drift of the system and the power meter). The absolute accuracy of the calibrated power will be dependent on the power meter and sensor used.</p> <p>Flat Power Calibrations A flat power calibration (when in frequency sweep mode) is available at a user-selectable power level, if it is within the power adjustment range of the internal source. The flat power correction is applied to other power levels.</p> <p>Linear Power Calibrations A linear power calibration is performed over a range of power levels for use in power sweep mode and is performed at a specified frequency or frequency range.</p> <p>External Power Meter Both calibrations are performed using an external power meter (Anritsu ML243xA, ML248xB, ML249xA, Agilent 437B (or equivalent), Keysight N191XA/EPM, or Rhode and Schwarz NRP2/NRX meter with a broadband 110 GHz sensor) over the Dedicated GPIB port, or a USB power sensor (Anritsu MA24106A, MA24108A, MA24118A, MA24126A, MA24208A, MA24218A, MA24330A, MA24340A, MA24350A, MA24507A, or MA24510A) connected to a USB port.</p> <p>Note: Usage of the MA24500A series sensor requires a dual USB Type A male to single USB Type A female cable to supply needed current draw. Due to certain bandwidth requirements, the MA24500A series can only be used for power calibrations above nominally -35 dBm on VectorStar. Accuracy with the MA24500A series of sensors (when used with VectorStar) may be degraded below 1 MHz.</p>
Embedding/De-embedding	<p>The MS4640B is equipped with an Embedding/De-embedding system.</p> <p>De-embedding De-embedding is generally used for removal of test fixture contributions, modeled networks and other networks described by S-parameters (s2p files) from measurements.</p> <p>Embedding Similarly, the Embedding function can be used to simulate matching circuits for optimizing amplifier designs or simply adding effects of a known structure to a measurement.</p> <p>Multiple Networks Multiple networks can be embedded/de-embedded and changing the port and network orientations is handled easily.</p> <p>Extraction Utility An extraction utility is part of this package that allows the easier computation of de-embedding files based on some additional calibration steps and measurements.</p>
Impedance Conversion	<p>Allows entry of different reference impedances (complex values) for different ports</p>

Mixer Setup	Mixer setup provides assistance to configure common mixer measurements including a simple, yet accurate, calibration methodology.
Mixer Setup – Single Channel	The prime objective of the guided Mixer Setup Single Channel is to help configure the frequency plan of the measurement using easy-to-understand diagrams. Mixers using harmonics of the LO are supported as are mmWave configurations (see ME7838x documentation).
Mixer Setup – Multiple Channel	The Mixer Setup Multiple Channels helps configure measurement channels to handle any of a suite of possible mixer measurements and to list the required calibration steps.
Mixer Calibration	Both of these tools are coupled with the mixer calibration menu system that enables both scalar and vector-corrected measurements. The user can be directed to power calibrations that are automatically set up based on the mixer configuration.
Dual Source Mixer	Allows easier external mixer setups and can take advantage of the flexibility of having two independent internal sources within the VNA.

Optional Capabilities

Time Domain Measurements — Option 2

Displays all S-parameters and overlays with Frequency Domain, Low-pass Mode, Band-pass Mode, Phasor Impulse Mode, Windowing, Gating (pass-band or reject-band), and Frequency with Time Gate. Low-pass mode requires a harmonically related frequency list (step size = start frequency). A harmonic sweep tool is available to help with this setup. In low-pass mode, the impulse or step response can be displayed (the latter for a TDR-like presentation). When applying gating, the impedance levels at gate edges can be changed to simplify de-embedding operations.

Receiver Offset — Option 7

Independent Source/Receive Functions	Allows for independent source and receive functions for Mixer, Harmonics, IMD and other measurements, where the source and receive frequencies are offset.
Multiple Source Control Mode	To independently control the frequencies of up to four external sources, in addition to the internal source(s), and the receiver, in a synchronized manner.
NxN Frequency-Translated Devices	Provides calibration and measurements capability for NxN Frequency-translated devices. For accurate and absolute magnitude and phase measurements of match, gain/loss, and group delay of devices such as mixers and converters.

Universal Fixture Extraction — Option 21

Provides a suite of additional network extraction techniques for different de-embedding problems, particularly those when only partial interface information is available at the DUT plane. These are often useful for on-wafer and fixtured environments with more complex DUT interfaces where traditional standards may not be available. In most cases, .s1p definition/model of reflect standards is allowed and generally automatic fixture length detection is available. In addition, a sequential extraction (peeling) of isolated fixture defects is possible and allows one to generate sNp files for portions of the fixture for design analysis.

Dual Source Architecture — Option 31

Description	Adds a second internal source to the VNA structure and removes the transfer switch. This architecture results in higher test port power and improved dynamic range. Combined with Option 7 Receiver Offset, allows two sources and the receiver to be active at the same time and at independent frequencies. When both sources are active and at the same frequency, a relative phase shift can be set between them. When combined with Option 43 DifferentialView™, adds the ability to perform true mode stimulus measurements of differential devices. The dual source mixer capability allows the flexibility of two independent sources within the VNA to allow external mixer measurements.
Required Options	None, except with the dual source mixer applications, which require Option 7.
System Compatible Options	Option 2 Time Domain Option 7 Receiver Offset Option 21 Universal Fixture Extraction Option 32 Internal RF Combiner Option 35 IF Digitizer Option 36 Extended IF Digitizer Memory Option 41 Noise Figure Option 42 PulseView™ Option 43 DifferentialView™ Option 44 IMDView™ Option 46 Fast CW Option 47 Eye Diagram Option 48 Differential Noise Figure Option 49 Spectrum Analysis Option 51 Direct Access Loops Option 53 External ALC Options 61/62 Active Measurements Suite Option 70 70 kHz Low Frequency Extension Options 84/85 Broadband/Banded/Millimeter-Wave Extension Options 88/89 Broadband/Banded/Millimeter-Wave Extension. Maximum frequency available is 110 GHz.
Incompatible Options	Options 80/81 Broadband/Millimeter-Wave Options 82/83 Banded/Millimeter-Wave Extension Options 86/87 Broadband/Millimeter-Wave. Maximum frequency available is 110 GHz.

Internal RF Combiner — Option 32

Description	Adds an internal combiner to combine Source 2 of the Dual Source Architecture option (Option 31) with Source 1 and routes to Port 1 of the VectorStar front panel. When combined with IMDView (Option 44) the configuration provides optimized intermodulation distortion (IMD) measurements. The Frequency Offset (Option 7) and Dual Source (Option 31) must be ordered with the combiner option. If IMDView (Option 44) is not included, switching of the combiner is activated using the Multiple Source Control menus supplied with the frequency offset option.
Required Options	Option 7 Receiver Offset and Option 31 Dual Source Architecture
System Compatible Options	Option 2 Time Domain Option 21 Universal Fixture Extraction Option 35 IF Digitizer Option 36 Extended IF Digitizer Memory Option 41 Noise Figure Option 42 PulseView™ Option 43 DifferentialView™ Option 44 IMDView™ Option 46 Fast CW Option 47 Eye Diagram Option 48 Differential Noise Figure Option 49 Spectrum Analysis Option 51 Direct Access Loops Option 53 External ALC Option 61/62 Active Measurements Suite Option 70 70 kHz Low Frequency Extension Options 84/85 Broadband/Banded/Millimeter-Wave Extension Options 88/89 Broadband/Banded/Millimeter-Wave Extension. Maximum frequency available is 110 GHz.
Incompatible Options	Options 80/81 Broadband/Millimeter-Wave Options 82/83 Banded/Millimeter-Wave Extension Options 86/87 Broadband/Millimeter-Wave. Maximum frequency available is 110 GHz

IF Digitizer — Option 35

Description	When combined with PulseView™ (Option 42), adds the capability to generate and measure pulsed signals. Four internal signal generators are included enabling singlet, doublet, triplet, quadruplet, and/or burst signal generation. Pulse measurements include pulse profile, point-in-pulse, and pulse-to-pulse capability.
Required Options	None
System Compatible Options	All
Incompatible Options	None
Multiport Systems	Compatible with the MN469xC Series Multiport System on any model VNA. Fast CW (non-pulsed) Captures up to 400 million data points per measurement channel with variable acquisition rates from 80 MHz to 400 MHz. This capability enables long time records (0.5 s to 2.5 s, depending on acquisition rate) stored in files retrievable via USB or a local area network.
Additional Information	For detailed pulse measurement theory, description, and operational information, see the VectorStar MS4640B Series VNA Calibration and Measurement Guide, 10410-00318.

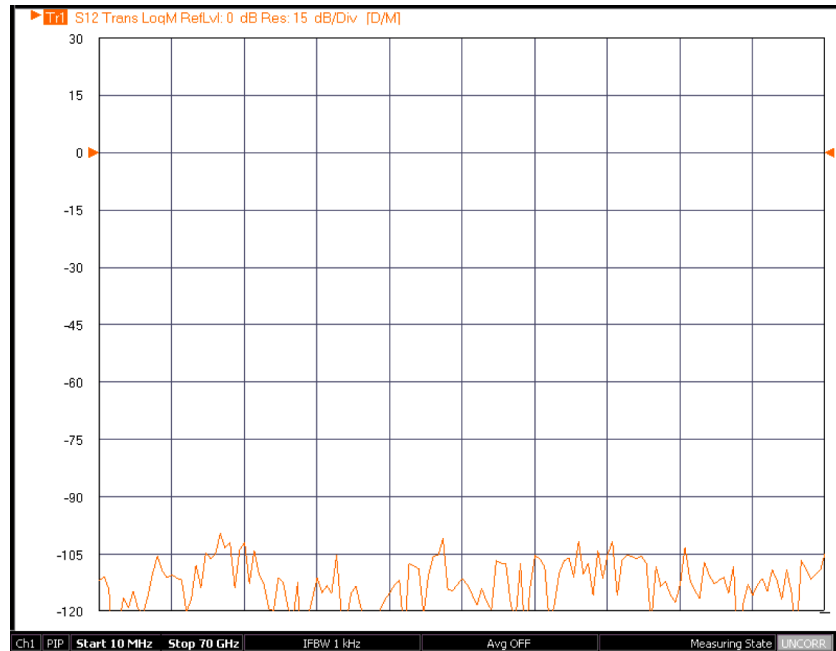

Typical plot of dynamic range with Option 35 activated.

Extended IF Digitizer Memory — Option 36

Description	Provides additional memory for the IF digitizer option to allow for longer record lengths. This option increases the maximum record length from 0.5 seconds to 2.5 seconds at the maximum sampling rate (minimum time resolution) with proportionate increases in record length increases at other sampling rates.
Required Options	Option -35 IF Digitizer
System Compatible Options	All
Incompatible Options	None

Noise Figure — Option 041

Description	Adds the capability to measure degradation of the signal-to-noise ratio caused by components in a signal chain. The Noise Figure measurement is based on a cold source technique for improved accuracy. Various levels of match and fixture correction are available for additional enhancement. Mixer noise figure measurements are supported. Compatible with mmWave measurements in the ME7838X family with the use of receiver-only modules (e.g., 3744A-Rx).
Required Options	Option -51 or Option -61 or Option -62
System Compatible Options	Option 2 Time Domain Option 7 Receiver Offset Option 21 Universal Fixture Extraction Option 31 Dual Source Architecture Option 32 Internal RF Combiner Option 35 IF Digitizer Option 36 Extended IF Digitizer Memory Option 42 PulseView™ Option 43 DifferentialView™ Option 44 IMDView™ Option 46 Fast CW Option 47 Eye Diagram Option 49 Spectrum Analysis Option 53 External ALC Option 70 70 kHz Low Frequency Extension Option 81 Broadband/Millimeter-Wave Option 83 Millimeter-Wave Extension Option 85 Broadband/Banded/Millimeter-Wave Extension Option 87 Broadband/Millimeter-Wave Option 89 Broadband/Banded/Millimeter-Wave Extension
Incompatible Options	Option 48 Differential Noise Figure Option 80 Broadband/Millimeter-Wave Option 82 Banded Millimeter-Wave Extension Option 84 Broadband/Banded/Millimeter-Wave Extension Option 86 Broadband/Millimeter-Wave Option 88 Broadband/Banded/Millimeter-Wave Extension
Multiport System	MN469xC Series Multiport System on any model VNA; Noise Figure measurements can only be performed when the system is configured as a 2-Port VNA.
Additional Information	For detailed Noise Figure measurement theory, description, and operational information, see the VectorStar MS4640B Series VNA Calibration and Measurement Guide, 10410-00318.

PulseView™ — Option 42

Description	When combined with Option 35 IF Digitizer, adds the capability to generate and measure pulsed signals. Four internal signal generators are included enabling singlet, doublet, triplet, quadruplet, and/or burst signal generation. Pulse measurements include pulse profile, point-in-pulse, and pulse-to-pulse capability. Allows pulsed leveling of source power at an external point (e.g., after a preamplifier).
Required Options	Option 35 IF Digitizer
System Compatible Options	All
Incompatible Options	None
Multiport Systems	Compatible with the MN469xC Series Multiport System on any model VNA
Additional Information	For detailed pulse generation and measurement capability theory, description, and operation information, see the VectorStar MS4640B Series VNA Calibration and Measurement Guide - 10410-00318.
Pulse Measurements	
Minimum Profile Width	2.5 ns (5 ns minimum for continuous profiling)
Minimum PIP Measurement Width	2.5 ns (5 ns minimum for continuous point-in-pulse)
P2P Measurement Width	Minimum 5 ns
Record Length	0.5 s
Pulse Repetition Frequency (PRF)	4 Hz to 67 MHz in Pulse mode; PRFs slower than 4 Hz can be measured in standard Transmission/Reflection mode with triggering.
Duty Cycle (DC) Dynamic Range Reduction (characteristic)	
1 % DC	0 dB
0.1 % DC	0 dB
0.01 % DC	0 dB
Pulse Generation	
Pulse Formats	Four (4) internal pulse generators: PG1-PG4.
Pulse Repetition Frequency (PRF) Range	4 Hz to 67 MHz
Maximum Pulse Width	0.25 s
Minimum Pulse Width	5 ns
RF Modulation	Requires an SM6628, SM6629, SM6630, or SM6631 Pulse Modulator Test Set (see next section)

RF Modulation (Pulse Modulator Test Sets for use with Option 42 PulseView™)

Description	Pulse Modulator Test Sets are available to pulse the RF stimulus and/or provide receiver gating (modulation). Receiver gating generally required only for higher power antenna and related applications where undesired pulses could saturate the VNA receiver. The Test Set frequency range is limited to that of the VNA with which it is used. Test Sets include necessary cabling and installation documentation.
Required Options	Option 35 IF Digitizer Option 42 PulseView™ Option 51 Direct Access Loops or Option 61/62 Active Measurements Suite
Requires one of the following compatible Pulse Modulator Test Sets	SM6628, 70 kHz to 40 GHz. Provides the MS4642B and MS4644B VNA with source modulation. SM6629, 70 kHz to 40 GHz. Provides the MS4642B and MS4644B VNA with source and receiver modulation. SM6630, 70 kHz to 70 GHz. Provides the MS4647B VNA with source modulation. SM6631, 70 kHz to 70 GHz. Provides the MS4647B VNA with source and receiver modulation.
Polarity	Low (< 1 V) = RF ON High (3.3 V ± 10 %) = RF OFF
Pulse Rise/Fall Time (typical)	5 ns (10 % to 90 %)
Insertion Loss (typical)	< 10 dB, 20 to 40 GHz < 12 dB, 20 to 40 GHz < 15 dB, 40 to 60 GHz < 20 dB, 60 to 70 GHz
On/Off Ratio (typical)	> 100 dB, 20 GHz > 95 dB, 20 to 60 GHz > 90 dB, 60 to 70 GHz
Max Input Power	+20 dBm max, 0 VDC max
Latency (typical)	35 ns

DifferentialView™ — Option 43

Description	When combined with Option 31 Dual Source Architecture, provides dual source control and calibrations required for stimulating and measuring differential devices. Allows true differential and common mode device drives. Corrects mismatch introduced error of the DUT to VNA interface via real and time calibration. This mode supports balanced in/out or combined balanced and single source drive configurations. In addition, it provides the ability to control amplitude and phase offsets of the drive conditions as well as swept phase offset for custom characterization.
Required Options	Option 31 Dual Source Architecture
System Compatible Options	All
Incompatible Options	None
Multiport Systems	Requires an MN469xC Series Multiport System for full differential characterization of a multiport device.

IMDView™ — Option 44

Description	When combined with Options 31, 32, and 7, IMDView provides user interface for setting up and performing IMD measurements. Interface configures and controls source routing and power and receiver calibrations, for baseband or mmWave VectorStar systems. Frequency Offset Option 7 required. If Options 31 and/or 32 are not included, the IMDView software will control external sources and perform power calibrations of external combiners.
Required Options	Option 7 Receiver Offset
System Compatible Options	Option 2 Time Domain Option 7 Receiver Offset Option 21 Universal Fixture Extraction Option 31 Dual Source Architecture Option 32 Internal RF Combiner Option 35 IF Digitizer Option 36 Extended IF Digitizer Memory Option 42 PulseView™ Option 43 DifferentialView™ Option 46 Fast CW Option 47 Eye Diagram Option 48 Differential Noise Figure Option 49 Spectrum Analysis Option 51 Direct Access Loops Option 53 External ALC Options 61/62 Active Measurements Suite Option 70 70 kHz Low Frequency Extension Options 84/85 Broadband/Banded/Millimeter-Wave Extension Options 88/89 Broadband/Banded/Millimeter-Wave Extension Maximum frequency available is 110 GHz. Options 80/81 Broadband/Millimeter-Wave Options 82/83 Banded/Millimeter-Wave Extension Options 86/87 Broadband/Millimeter-Wave. Maximum frequency available is 110 GHz.
Multiport System	Compatible with the MN469xC Series Multiport System on any model VNA; IMDView measurements can only be performed when the system is configured as a 2-Port VNA.
Additional Information	For detailed IMD measurement theory, description and operational information, see the VectorStar MS4640B Series VNA Calibration and Measurement Guide - 10410-00318.

Fast CW — Option 46

Description: Standard Mode Fast CW	If Option 35 is not installed then Standard Mode Fast CW operations are available in T/R mode via remote commands. Standard Option CW supports both continuous data streaming and buffered data collection maximum data rates of ~200,000 measurements/second. The maximum buffer size is up to 60 million measurements with transfer blocks of up to 5 million measurements. Fast transfers are available for both streaming and buffered modes. Data extraction at corrected and final formatted layers is permitted.
Description: Advanced Fast CW	With Options 35 and 46 installed, Advanced Fast CW becomes available that allows data rates of up to 100,000,000 measurements/second on all receivers at once and buffers of up to 800,000,000 measurements deep (with Option 36). Advanced Fast CW is available in the user interface as well as remotely and has on-board synchronization choices and data reduction functionality.
Required Options	Option 35 IF Digitizer (required for Advanced Fast CW only)
System Compatible Options	All
Incompatible Options	None

Eye Diagram — Option 47

Description	Adds the capability to calculate an eye diagram representation of what the currently measured trace data would do to a digital data stream (that can be configured by the user). This is particularly valuable in seeing the data stream signal integrity issues that could occur with a given transmission path and can help with building up subsystem simulation results. Since the eye diagram computation is per-trace, one can configure a single channel having frequency domain, time domain impulse response, TDR-like and eye diagram traces simultaneously and all responding to the same live data. Both NRZ and PAM-4 signaling available.
Required Options	Option -2 Time Domain
System Compatible Options	All
Incompatible Options	None
Additional Information	For detailed Eye Diagram measurement theory, description and operational information, see the VectorStar MS4640B Series VNA Calibration and Measurement Guide - 10410-00318.

Differential Noise Figure — Option 48

Description	Includes all the functionality of Option 41 and allows measurement of differential and common-mode noise properties with the cold source method. Three operating modes (uncorrelated, correlated, and combiner-based) are available for measurement efficiency and accuracy optimization. Full treatment of output port correlation is available for 3- and 4-port DUTs. Mixer noise figure measurements are supported. Various levels of vector correction are available, as is full fixture/probe embedding and de-embedding. Compatible with mmWave measurements in the ME7838X family with the use of receiver-only modules (e.g., 3744A-Rx).
Required Options	Option 51 or Option 61 or Option 62
System Compatible Options	Option 2 Time Domain Option 7 Receiver Offset Option 21 Universal Fixture Extraction Option 31 Dual Source Architecture Option 32 Internal RF Combiner Option 35 IF Digitizer Option 36 Extended IF Digitizer Memory Option 42 PulseView™ Option 43 DifferentialView™ Option 44 IMDView™ Option 46 Fast CW Option 47 Eye Diagram Option 49 Spectrum Analysis Option 53 External ALC Option 70 70 kHz Low Frequency Extension Option 81 Broadband/Millimeter-Wave Option 83 Millimeter-Wave Extension Option 85 Broadband/Banded/Millimeter-Wave Extension Option 87 Broadband/Millimeter-Wave Option 89 Broadband/Banded/Millimeter-Wave Extension
Incompatible Options	Option 41 Noise Figure Option 80 Broadband/Millimeter-Wave Option 82 Banded Millimeter-Wave Extension Option 84 Broadband/Banded/Millimeter-Wave Extension Option 86 Broadband/Millimeter-Wave Option 88 Broadband/Banded/Millimeter-Wave Extension
Multiport System	MN469xC Series Multiport System on any model VNA; Differential Noise Figure measurements can be performed when the system is configured as a 2-Port VNA or a 4-Port VNA.
Additional Information	For detailed Differential Noise Figure measurement theory, description, and operational information, see the VectorStar MS4640B Series VNA Calibration and Measurement Guide, 10410-00318.

Spectrum Analysis — Option 49

Description	Allows for convenient spectral domain measurements of quantities such as harmonics, spurs, other distortion products, and general frequency content of a variety of a devices. The user interface is configured in a way closer to that of classical spectrum analyzers, but a number of VNA-like behaviors are available, including many different sweep modes, source drive, power and receiver calibrations, multiple receiver measurements, and multiple source control for complex frequency plans.
Required Options	Option 7 Receiver Offset
System Compatible Options	All
Incompatible Options	None
Additional Information	For detailed System Analysis theory, description, and operational information, see the VectorStar MS4640B Series VNA Calibration and Measurement Guide, 10410-00318.

Direct Access Loops — Option 51

Access Loops Per Port	Adds three (3) Access loops per port for Source, Test, and Receive Paths. Note: Direct access loops are not available for VNAs equipped with Option 61 or 62, which include access loops.
Front Panel Loops	≥ 2.5 GHz Frequency Coverage loops, located at front panel.
Rear Panel Loops	< 2.5 GHz Frequency Coverage loops, located at rear panel.

External ALC — Option 53

External ALC access allows leveling of source power at an external point (e.g., after a preamplifier). The connector and functionality are included with Option -8x for use with the modular broadband and mmWave functions (when in a 3739 mode, the broadband/mmWave functionality takes precedence).

Required Options	Option 61 or 62
System Compatible Options	All
Incompatible Options	None

Active Measurements Suite — Option 61/62

Adds Step Attenuators, Bias Tees, Direct Access Loops, and Gain Compression and Efficiency Measurement Capabilities.

MS4642B Attenuators	70 dB, 10 dB/step
MS4644B Attenuators	70 dB, 10 dB/step
MS4647B Attenuators	60 dB, 10 dB/step
Option 61	Two (2) attenuators: One in Source 1 path, and one in Receive 2 path.
Option 62	Four (4) attenuators: One in each Source path and in each Receive path.
Bias Tees	0.5 A maximum, 40 VDC maximum 3 kHz BW (nominal), looking into a High Impedance 10 M Ω to Ground for DUT Static Discharge Protection located at rear panel.
Access Loops	Includes Option 51 loops, listed above. (Options 51, 61, and 62 are mutually exclusive)
Gain Compression	Swept Power Gain Compression at a CW frequency $P_{x\text{ dB}}$ over Swept Frequency, up to 401 points.

70 kHz Low End Frequency Extension — Option 70

Extends the VNA standard 10 MHz low-end start frequency to 70 kHz, providing 70 kHz to 20, 40, or 70 GHz coverage models. The low-end is allowed to extend to 40 kHz.

Broadband/Banded/Millimeter-Wave Extensions — Option 8x

Option 80	Broadband/Millimeter-Wave. For broadband systems with a single-source VNA and without loop options (51, 61 or 62)
Option 81	Broadband/Millimeter-Wave. For broadband systems with a single-source VNA and with a loop option.
Option 82	Banded Millimeter-Wave Extension. For banded systems with a single-source VNA and without loop options (51, 61 or 62)
Option 83	Millimeter-Wave Extension. For banded systems with a single-source VNA and with a loop option.
Option 84	Broadband/Banded/Millimeter-Wave Extension. For systems with a dual-source VNA and without loop options (51, 61 or 62)
Option 85	Broadband/Banded/Millimeter-Wave Extension. For systems with a dual-source VNA and with a loop option.
Option 86	Broadband/Millimeter-Wave. For 110 GHz-limited broadband systems with a single-source VNA and without loop options (51,61 or 62)
Option 87	Broadband/Millimeter-Wave. For 110 GHz-limited broadband systems with a single-source VNA and with a loop option.
Option 88	Broadband/Banded/Millimeter-Wave Extension. For 110 GHz-limited broadband systems with a dual-source VNA and without loop options (51, 61 or 62)
Option 89	Broadband/Banded/Millimeter-Wave Extension. For 110 GHz-limited broadband systems with a dual-source VNAs and with a loop option.

CPU, OS, Memory, and Security Features

CPU	Intel Core™ i5
O/S	The Microsoft® Windows 10 IoT operating system on the MS4640B Series VNA is configured for optimum performance when the instrument leaves the factory.
Display	26.4 cm (10.4") Color XGA Touch-Screen Display
Storage	Serial-ATA (SATA) Solid State Drive (SSD), for OS, Programs, and Data. (> 100 GB)

Security Features

Display Blanking	For security, VectorStar software can obscure frequencies displayed on the system UI.
Removable Internal Drive	Rear Panel accessible Solid State Drive (SSD) is quickly removable and easy to secure.
Option 4 Spare SSD	A bootable SSD module is available as a spare for VectorStar units used in multiple or compartmentalized locations. The VectorStar's operating system and software are pre-installed on each Option -4 SSD.
Virus Protection, Best Practices	If the VNA is attached to a network, best practices recommend installing anti-virus software.

Front Panel Connections of VNA

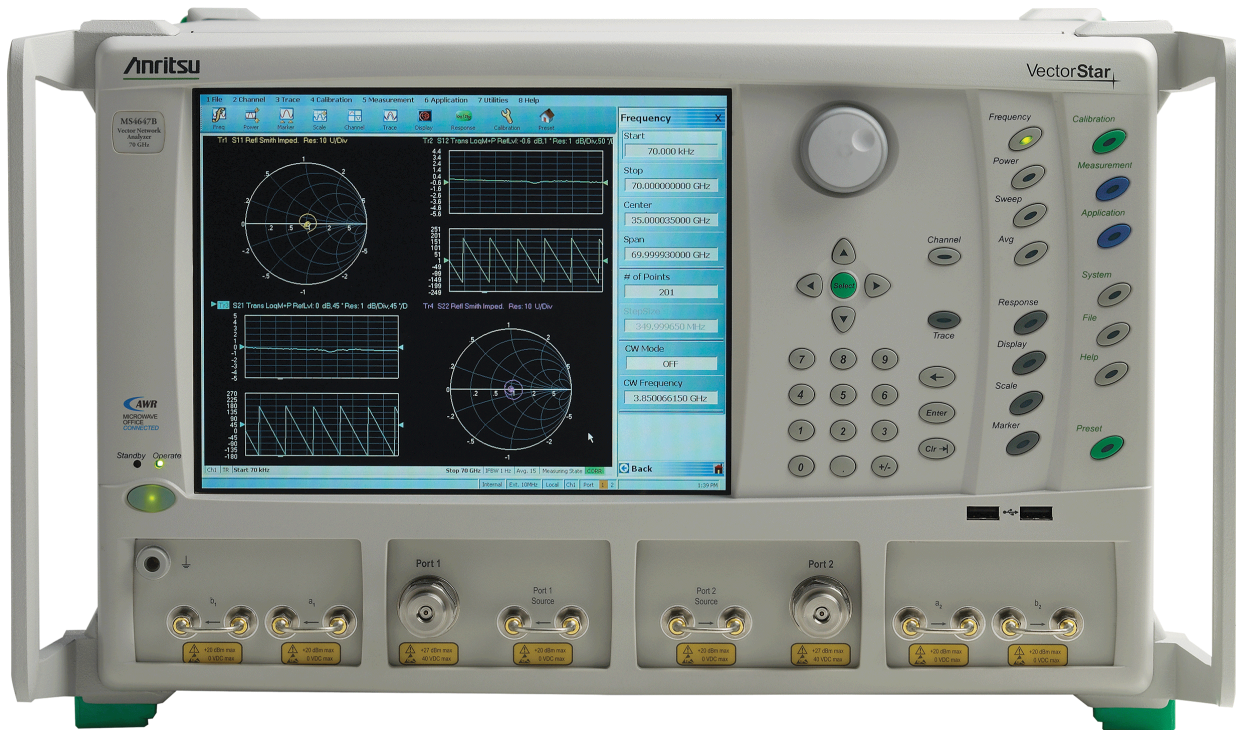

MS4640B Front Panel

Test Ports 1 and 2

Type	Universal Test Port Connectors, easily exchangeable in case of damage.
MS4642B and MS4644B	K (male)
MS4647B	V (male)
Damage Input Levels	+27 dBm maximum, 40 VDC maximum

Direct Access Loops (optional)

Type	For Source, Test and Receive paths, 3 per port, for ≥ 2.5 GHz frequency coverage.
MS4642B and MS4644B	K (females)
MS4647B	V (females)
Damage Input Levels	+20 dBm maximum, 0 VDC maximum (+27 dBm maximum on source loop ports)

USB Ports

Four type A USB 2.0 Ports (two each on the front and rear panel) for peripherals such as keyboard, mouse, memory stick, hardware key, and similar devices.

Chassis Grounding Port

Banana (female)

Ports to Millimeter-Wave Test Set (optional)

Connector Type K (female) (LO1, and LO2 for RF; One with single source; Two with Option 31 Dual Source)

Rear Panel Connections of VNA



MS4640B Series Rear Panel (with Option 35)

AC Power Input	AC Input connector, with On/Off switch, and fuses 350 VA maximum, 90 to 264 VAC, 47 to 63 Hz (power factor controlled)
Power Consumption	420 VA
USB, PS/2, and LAN	
USB Control Port	Type B USB 2.0 port for controlling the instrument externally, for remote operation
USB Ports	Two Type A USB 2.0 Ports for peripherals such as keyboard, mouse, memory stick, hardware key, etc. (Two more USB ports at the front panel)
Keyboard and Mouse Ports	Dedicated PS/2 ports.
LAN Port	10/100BaseT Ethernet
GPIB Ports	
GPIB Port (Talker/Listener)	Type D-24, female, IEEE 488.2 compatible, for controlling the instrument externally, for remote operation.
GPIB Port (Dedicated Controller)	Type D-24, female, for the control of external instruments such as power meters, external test sets, and similar devices.
External I/O Port	
Type	25-pin D-Sub, female, User-defined I/O for custom external test set interface, to synchronize with different sweep states, such as Start, Stop, Driven Port, and similar parameters.
Pin 1	Limit Pass/Fail
Pins 2, 3, 15, 16	TTL In
Pins 4, 13 14, 21	GND
Pins 5-12, 17-20, 22	TTL Out
Pins 23-25	Reserved
Serial Port	9-pin D-Sub, male, compatible with RS-232, provides control for AutoCal modules and similar devices.
VGA Port	15-pin mini D-Sub, for simultaneously projecting the instrument's screen display onto an external VGA monitor, with 1024 x 768 minimum resolution.
Bias Inputs	
Optional Bias Inputs	Requires Active Measurement Suite, Option 61 or 62
Bias Fuses	BNC (female), one per port 0.5 A, 250 V, one per port

Direct Access Loops		Description	For Source, Test, and Receive paths, 3 per port, for < 2.5 GHz frequency coverage.
		Required Options	Option 51, 61, or 62
		Connector Type	SMA (female)
		Damage Input Levels	+20 dBm maximum, 0 VDC maximum (+27 dBm maximum on source loop ports)
IF Inputs/Outputs		a ₁ , a ₂ , b ₁ , b ₂ , IF Inputs/Outputs	
		Connector Type	SMA (female)
		Inputs	Inputs used with external converters such as millimeter-wave modules, or for antenna testing. (Requires Option 8x)
		Outputs	Outputs used with external IF digitizers and processors. (Used for service.)
		Nominal Inputs	5 to 200 MHz (mode dependent), 0 dBm for full scale
		Nominal Outputs	0.2 to 200 MHz (mode dependent), +10 dBm maximum
10 MHz In		Signal presence is auto-sensing (better than 1000 ppm frequency accuracy is recommended).	
		Connector Type	BNC (female)
		Signal	-10 dBm to +3 dBm, 50 Ω Nominal
10 MHz Out		Derived from the internal reference, unless an external 10 MHz reference input is applied.	
		Connector Type	BNC (female)
		Signal	0 ± 5 dBm sinusoidal, 50 Ω Nominal
Analog In 1 and 2		Two independent inputs for measurements simultaneous with the RF measurements, for current sensing, efficiency computation, power detection, and similar parameters.	
		Connector Type	BNC (female)
		Range	-10 V to +10 V with automatic offset and gain calibrations
		Accuracy	2 mV + 2 % for V < 5 V; 2 % for V > 5 V
		Nominal Input Impedance	60 kΩ
Ext In ALC 1 and ALC 2		For external automatic level control of the internal signal source generators. The input assumes 0 V represents no RF power and a larger negative value represents increasing RF power. The maximum range is 0 to -1.3V.	
		Optional	ALC 1 is available with Options 53/80/81/82/83/86/87 ALC 1 and ALC 2 are both available with Options 31 and 53/84/85/88/89
		Connector Type	BNC (female)
Ext Analog Out		For external attenuator control, external switch control, analog triggering assistance, measurement system integration, and other purposes.	
		Connector Type	BNC (female)
		Normal Operating Modes	Sawtooth sync sweep, TTL indication of driving port, open loop level controller
		Range	-10 V to +10 V; low impedance drive
		Accuracy	20 mV + 2 % (Load: > 5 kΩ)
Ext Trigger		Connector Type	BNC (female)
		Voltage Input	0 to 3.3 V input (5 V tolerant) Low threshold = 0.8 V High threshold = 2 V
		Impedance	High impedance (> 100 kΩ)
		Pulse Width	100 ns minimum input pulse width
		Edge Trigger	Programmable edge trigger
Lock Status		Connector Type	BNC (female)
		Voltage Input	0 to 3.3 V input (5 V tolerant) Low threshold = 0.8 V High threshold = 2 V
		Impedance	High impedance (> 100 kΩ)
		Pulse Width	100 ns minimum input pulse width
		Edge Trigger	Positive-edge trigger
Ready for Trigger		Connector Type	BNC (female)
		Voltage Input	0 to 3.3 V latched output
		Impedance	Low impedance (approximately 50 Ω)
		Voltage	V _(output high) = 2 V min @ -12 mA V _(output low) = 0.8 V max @ +12 mA

Trigger Out

Connector Type	BNC (female)
Voltage Output	0 to 3.3 V pulse output 1 μ s positive pulse
Voltage	$V_{(output\ high)} = 2\ V\ min\ @\ -12\ mA$ $V_{(output\ low)} = 0.8\ V\ max\ @\ +12\ mA$
Impedance	Low impedance (approximately 50 Ω)

Pulse Generator Outputs All values listed are nominal.

Optional	Requires Options 35 and 42 PulseView™
Connector Type	SMA (female)
Pulse Generator Outputs	P GEN 1, P GEN 2, P GEN 3, and P GEN 4
Voltage	High: 3.3 V \pm 10 % Low: < 1 V
Drive Impedance	Low impedance (approximately 50 Ω)
Load Impedance	50 Ω or higher impedance

Pulse Sync Input All values listed are nominal.

Optional	Requires Options 35 and 42 PulseView™
Connector Type	SMA (female)
Voltage Input	High threshold: 2.2 V Low threshold: 1 V
Signal	5.5 VDC damage level
Latency	55 ns delay from received sync to T_0 (typical)
Impedance	High impedance input

Pulse Sync Output All values listed are nominal.

Optional	Requires Options 35 and 42 PulseView™
Connector Type	SMA (female)
Voltage Output	High: 3.3 V \pm 10 % Low: < 1 V
Signal	5.5 VDC damage level
Latency	< 5 ns delay from T_0 to providing an external sync (typical)
Drive Impedance	Low impedance (approximately 50 Ω)
Load Impedance	50 Ω or higher impedance

Mechanical and Environmental**Dimensions**

	Dimensions listed are for the MS464xB instrument without rack mount option (MS4640B-001) attached.
Height	267 mm body (6U) 286 mm between feet outer edges
Width	426 mm body 457 mm between feet outer edges 487 mm between front panel handle outer edges
Depth	502 mm body 591 mm between handle and foot outer edges

Weight

< 30 kg (< 66 lb) (typical weight for a fully-loaded MS4647B VNA)

Environmental – Operating

Specification	Conforms to MIL-PRF-28800F (class 3)
Temperature Range	0 °C to +50 °C without error codes Except for 'unleveled' error messages that may occur at the extreme edges of the temperature range.
Relative Humidity	5 % to 90 % at +30 °C, Non-condensing
Altitude	4,600 m (15,000 ft)

Environmental – Non-Operating

Temperature Range	-40 °C to +71 °C
Relative Humidity	0 % to 95 % at +30 °C, Non-condensing
Altitude	4,600 m (15,000 ft)

Regulatory Compliance

European Union	EMC 2014/30/EU, EN 61326-1:2013, CISPR 11/EN 55011, IEC/EN 61000-4-2/3/4/5/6/8/11 Low Voltage Directive 2014/35/EU Safety EN 61010-1:2010 RoHS Directive 2011/65/EU & Amendment 2015/863
United Kingdom	EMC SI 2016/1091; BS EN 55011 & BS EN 61000-4-2/3/4/5/6/8/11 Consumer Protection (Safety) SI 2016/1101; BS EN 61010-1:2010 Environmental Protection SI 2012/3032; 2011/65/EU & 2015/863
Canada	ICES-1(A)/NMB-1(A)
Australia and New Zealand	RCM AS/NZS 4417:2012

MN4765B O/E Calibration Module

The MN4765B is a characterized, unamplified photodiode module. It is used as an optical receiver with the Anritsu MS4640B Series VectorStar VNAs to perform highly accurate and stable optoelectronic measurements of both modulators (E/O) and photoreceivers (O/E). Model MN4765B is the base calibration module part number only. Customers are required to also order an option to configure the bandwidth and wavelength coverage. These options consist of an InGaAs photodiode that converts modulated optical signals to electrical signals, and includes additional circuitry for temperature and bias stability. For more details on the MN4765B module, see the Technical Data Sheet 11410-00843.



MN4765B O/E Calibration Module

Configuration Option	Description	Additional Information	Part Number
40	70 kHz to 40 GHz range, with 850 wavelength coverage	RF Out K (male)	MN4765B-0040
42	70 kHz to 40 GHz range, with 850 and 1060 nm wavelength coverage	RF Out K (male)	MN4765B-0042
43	70 kHz to 40 GHz range, with 850/1060/1310/1550 nm wavelength coverage	RF Out K (male)	MN4765B-0043
70	70 kHz to 70 GHz range, with 1550 nm wavelength coverage	RF Out V (male)	MN4765B-0070
71	70 kHz to 70 GHz range, with 1310 nm wavelength coverage	RF Out V (male)	MN4765B-0071
72	70 kHz to 70 GHz range, with 1310 and 1550 nm wavelength coverage	RF Out V (male)	MN4765B-0072
110	70 kHz to 110 GHz range, with 1550 nm wavelength coverage	RF Out W1 (male), 1 mm	MN4765B-0110
111	70 kHz to 110 GHz range, with 1310 nm wavelength coverage	RF Out W1 (male), 1 mm	MN4765B-0111
112	70 kHz to 110 GHz range, with 1310 and 1550 nm wavelength coverage	RF Out W1 (male), 1 mm	MN4765B-0112
Calibration Option	Description		Part Number
98	Standard Calibration - Includes Certificate of Calibration		MN4765B-0098
99	Premium Calibration - Includes Certificate of Calibration and Test Data		MN4765B-0099

MN4765B O/E Calibration Module Features

Fast and Accurate Measurements	The MS4640B Series VectorStar series VNAs, when calibrated using the MN4765B module, enable error-corrected Transfer Function, Group Delay, and Return Loss measurements of E/O, O/E, and O/O components and subsystems.
National Institute of Standards	Magnitude and phase characterization is obtained either using a primary standard characterized by NIST or other National Metrology Institutes and held by the Anritsu calibration lab, or based on model transfer and interpolation from primary-derived characterizations at other wavelengths. The magnitude and phase data is provided on a USB drive with the module.
Temperature Stable	The MN4765B is thermally stabilized to eliminate drift in photodiode performance over temperature.
Internal Biasing	Accurate bias voltage to the photodiode is maintained internally. An external, multi-country, AC adapter is included for easy operation.
High Linearity	Linear operating range to +6 dBm for transfer function measurement uncertainties of: < 0.5 dB at 40 GHz (typical specifications for MN4765B-0043 at 1550 or 1310 nm) < 1 dB at 40 GHz (typical specifications for MN4765B-004x at 850 nm) < 2 dB at 40 GHz (typical specifications for MN4765B-0042 and MN4765B-0043 at 1060 nm) < 0.45 dB at 50 GHz and < 0.7 dB at 70 GHz (typical spec for MN4765B-0070 and MN4765B-0072 at 1550nm) < 0.35 dB at 40 GHz and < 1 dB at 70 GHz (typical spec for MN4765B-0071 and MN4765B-0072 at 1310 nm) < 0.5 dB at 70 GHz and < 0.75 dB at 110 GHz (typical specifications for MN4765B-0110)
High Responsivity	> 0.2 A/W for MN4765B-0040 (850 ± 20 nm) (typical specification) > 0.2 A/W for MN4765B-0042 (850 ± 20 nm), > 0.6 A/W (1060 ± 20 nm) (typical specification) > 0.2 A/W for MN4765B-0043 (850 ± 20 nm), > 0.6 A/W (1060 ± 20 nm), > 0.7 A/W (1310 ± 20 nm), and > 0.8 A/W (1550 nm ± 20 nm) (typical specification) > 0.7 A/W for MN4765B-0070 (typical specification) > 0.45 A/W for MN4765B-0071 (typical specification) > 0.45 A/W for MN4765B-0072 at 1310 nm (typical specification) > 0.65 A/W for MN4765B-0072 at 1550 nm (typical specification) > 0.5 A/W for MN4765B-0110 (typical specification)

MN4765B O/E Calibration Module (continued)

MN4765B O/E Calibration Module General and Environmental

Optical Input	FC/APC
Dimensions	33 H x 51 W x 127 D mm (1.3 H x 2.0 W x 5.0 D in)
AC Adapter	100 V to 240 V (50 Hz to 60 Hz) input, +12 VDC output
Power Consumption	OE module consumes less than 250mA at +12 VDC
Power LED	On when the AC adapter is plugged in and the internal photodiode is properly biased
Operate LED	On when the module's internal temperature has stabilized at an optimum temperature for accurate calibrations and measurements
Calibrated Temperature	23 °C ± 3 °C
Operating Temperature	18 °C to 28 °C
Storage Temperature	-20 °C to 70 °C (-15 °C to 60 °C for -004x)
Relative Humidity	5 % to 95 %
EMI	Conforms to and meets the requirements of the following:
EMC Directive	Conforms to the EMC Directive, 2004/108/EC per EN 61326-1:2013
Low Voltage Directive	2006/95/EC
Emissions	EN 55011:2009 +A 1:2010 Group 1 Class A
Immunity	EN61000-4-2/3/4/5/6/11

MN4775A E/O Converter Features



Introduction

The MN4775A is an electrical to optical converter that uses an RF input signal to intensity modulate an internal laser. The E/O converter is used in conjunction with the VectorStar MS464xB series VNAs and the MN4765B optical to electrical (O/E) Calibration Module to perform highly accurate and stable optoelectronic measurements of both modulators (E/O) and photoreceivers (O/E). The MN4775A includes a laser, an optical Mach-Zehnder intensity modulator and a variable optical attenuator to control its output power. Internal circuitry provides various power and modulation configurations as well as stabilizes overall performance. Options determine the wavelength of operation: 850 nm for Option -0040, C-band (1527.6 to 1565.5 nm) for Option -0070/-0110, and 1310 nm for Option -0071. Option -0072/-0111 includes both a C-band and a fixed 1310 nm laser connected by an optical switch.

Configuration Options

MN4775A-0040	40 GHz modulation bandwidth and internal 850 nm laser
MN4775A-0070	70 GHz modulation bandwidth and internal C-band laser set to 1550 nm
MN4775A-0071	70 GHz modulation bandwidth and internal 1310 nm fixed laser
MN4775A-0072	70 GHz modulation bandwidth and both fixed 1310 nm laser and C-band laser set to 1550 nm (optically switched)
MN4775A-0110	110 GHz modulation bandwidth and internal C-band laser set to 1550 nm
MN4775A-0111	110 GHz modulation bandwidth and internal 1310 nm fixed laser

Features

- Fully integrated E/O to support a complete optoelectronic characterization system
- Mach-Zehnder intensity modulator and bias controller with manual and fully automatic operation modes
- Variable Optical Attenuator (VOA) for automatic or manual power control
- Internal biasing for stable operation and temperature compensation
- Internal optical power detection/monitoring
- Configurability for adapting to measurement applications
 - Optical output power control
 - Modulator biasing alternatives
 - Intuitive Touchscreen Front panel control of optical components, as well as remote control via rear panel USB or RS-232 connections
 - In Options 7x and 11x, a jumper loop is provided which enables using an external laser (with the internal modulator and output control) from 1250 nm to 1610 nm.

Block Diagram

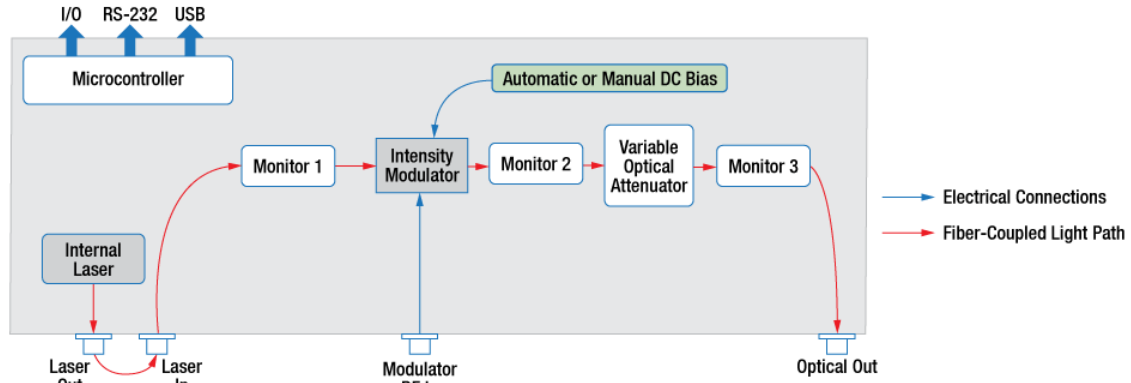

Note: The MN4775A-0040 850 nm E/O Converter does not have an external jumper for the optical path. The MN4775A-0072 has two lasers switched into the internal laser path in the diagram.

Mechanical Specifications

Dimensions	Width: 250 mm (9.84 in)
	Height: 134.8 mm (5.31 in)
	Depth: 300 mm (11.81 in)
	Height without feet: 122 mm (4.8 in)
Weight	< 4 kg (< 8.5 lb)

Power and Environmental Specifications

	Min	Max
Main AC Voltage	100 VAC	250 VAC
Power Consumption	-	60 VA
Line Frequency	50 Hz	60 Hz
Operating Temperature	10 °C	40 °C
Storage Temperature	0 °C	50 °C
Relative Humidity	5%	85%

Regulatory Compliance

European Union	EMC 2014/30/EU, EN 61326:2013, CISPR 11/EN 55011, IEC/EN 61000-4-2/3/4/5/6/8/11 Low Voltage Directive 2014/35/EU Safety EN 61010-1:2010 RoHS Directive 2011/65/EU & Amendment 2015/863
Canada	ICES-1(A)/NMB-1(A)
United Kingdom	EMC SI 2016/1091; BS EN 55011 & BS EN 61000-4-2/3/4/5/6/8/11 Consumer Protection (Safety) SI 2016/1101; BS EN 61010-1:2010 Environmental Protection SI 2012/3032; 2011/65/EU & 2015/863
Australia and New Zealand	RCM AS/NZS 4417:2012

Ordering Information

Instrument Models	The ME7848A/E series systems are available to meet different frequency range requirements.
ME7848A-0210	110 GHz 1550 nm system with O/E Calibration Module and E/O Converter (based on ME7838AX broadband VNA system)
ME7848A-0211	110 GHz 1310 nm system with O/E Calibration Module and E/O Converter (based on ME7838AX broadband VNA system)
ME7848E-0210	110 GHz 1550 nm system with O/E Calibration Module and E/O Converter (based on ME7838EX broadband VNA system)
ME7848E-0211	110 GHz 1310 nm system with O/E Calibration Module and E/O Converter (based on ME7838EX broadband VNA system)
ME7848A-0240	40 GHz, 850 nm system with O/E Calibration Module and E/O Converter (Requires Option 51, 61, or 62 (for MS4644B), sold separately)
ME7848A-0270	70 GHz, 1550 nm system with O/E Calibration Module and E/O Converter (Requires Option 51, 61, or 62 (for MS4647B), sold separately)
ME7848A-0271	70 GHz, 1310 nm system with O/E Calibration Module and E/O Converter (Requires Option 51, 61, or 62 (for MS4647B), sold separately)
ME7848A-0272	70 GHz, 1310/1550 nm system with O/E Calibration Module and E/O Converter (Requires Option 51, 61, or 62 (for MS4647B), sold separately)
ME7848A-0110	110 GHz 1550 nm system with O/E Calibration Module only (based on ME7838AX broadband VNA system)
ME7848A-0111	110 GHz 1310 nm system with O/E Calibration Module only (based on ME7838AX broadband VNA system)
ME7848A-0112	110 GHz 1310/1550 nm system with O/E Calibration Module only (based on ME7838AX broadband VNA system)
ME7848E-0110	110 GHz 1550 nm system with O/E Calibration Module only (based on ME7838EX broadband VNA system)
ME7848E-0111	110 GHz 1310 nm system with O/E Calibration Module only (based on ME7838EX broadband VNA system)
ME7848E-0112	110 GHz 1310/1550 nm system with O/E Calibration Module only (based on ME7838EX broadband VNA system)
ME7848A-0140	40 GHz, 850 nm system with O/E Calibration Module only (Requires Option 51, 61, or 62 (for MS4644B), sold separately)
ME7848A-0170	70 GHz, 1550 nm system with O/E Calibration Module only (Requires Option 51, 61, or 62 (for MS4647B), sold separately)
ME7848A-0171	70 GHz, 1310 nm system with O/E Calibration Module only (Requires Option 51, 61, or 62 (for MS4647B), sold separately)
ME7848A-0172	70 GHz, 1310/1550 nm system with O/E Calibration Module only (Requires Option 51, 61, or 62 (for MS4647B), sold separately)
Included Accessories	Each system comes with a set of included accessories.
Online Help	The instrument is equipped with context-sensitive help built from the VectorStar Operation Manual, User Interface Reference Manual, Programming Manual, Programming Manual Supplement, and Calibration and Measurement Guide.
Peripherals	Optical USB Mouse
Power	Power Cord
2000-1957-R	Accessory Kit, 40 GHz (-0x40 systems) 2 one meter F-M K RF cables 1 one meter FC/PC-FC/APC fiber patch cord 2 semi-rigid K cables to allow VNA coupler reversal for increasing forward dynamic range 1 F-F K adapter Optical connector cleaning accessories (for both fiber ends and ferrule-based connectors)
2000-1958-R	Accessory Kit, 70 GHz (-0x7x systems) 2 one meter F-M V RF cables 1 one meter FC/PC-FC/APC fiber patch cord 2 semi-rigid V cables to allow VNA coupler reversal for increasing forward dynamic range 1 F-F V adapter Optical connector cleaning accessories (for both fiber ends and ferrule-based connectors)
2000-2119-R	Accessory kit (110 GHz systems) 2 (13 cm) F-M W RF cables 1 one meter FC/PC-FC/APC fiber patch cord 1 F-F W adapter Optical cleaning accessories (for both fiber ends and ferrule-based connectors)

**'Reversed' loop configurations (using semi-rigid cables in the accessory kits)
Does not apply to -021x or -011x systems.**



Rear Panel: 'Normal' (left) and 'Reversed' (right) Configurations



Front Panel: 'Normal' (left) and 'Reversed' (right) Configurations

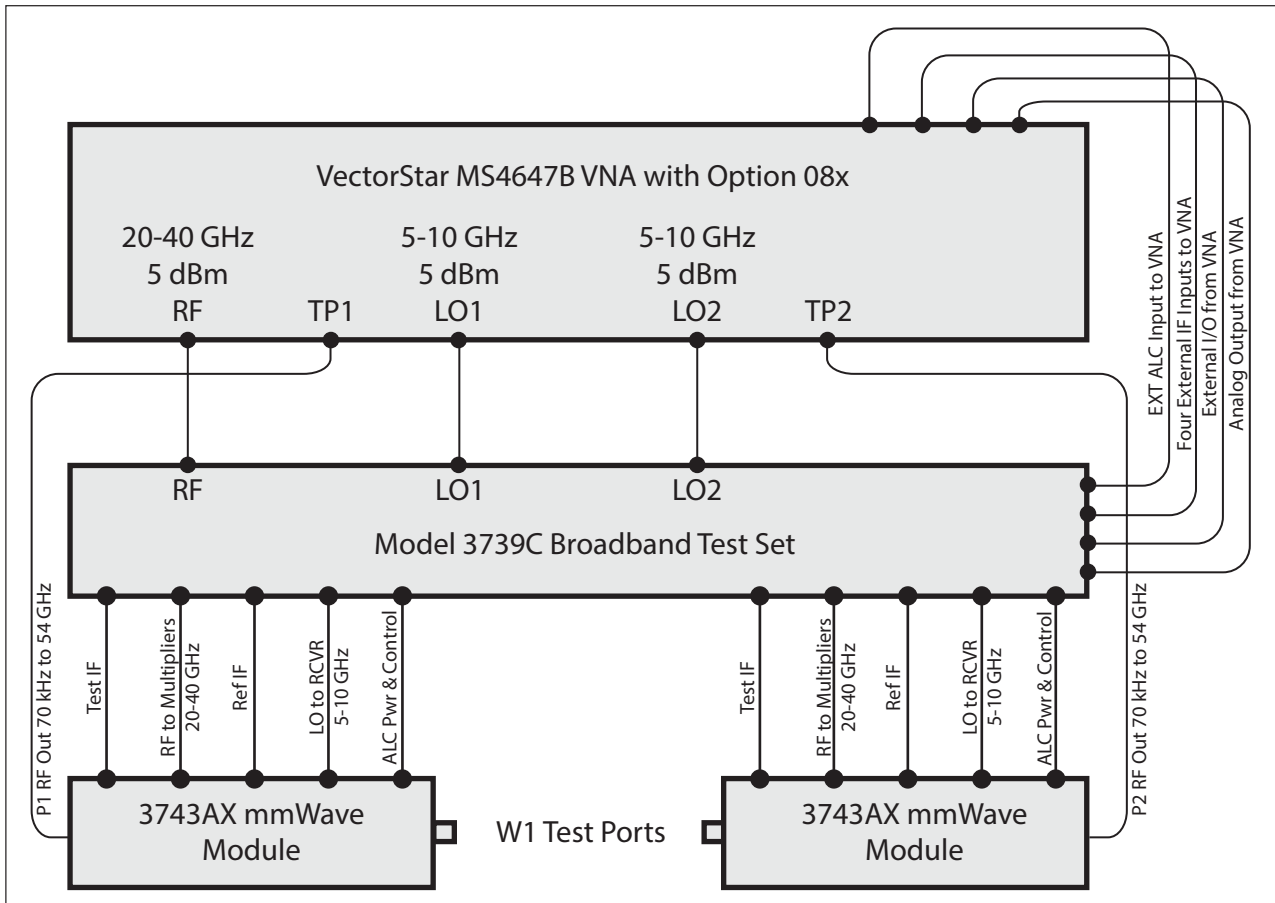

Broadband Configuration

Optoelectronic Measurement System Options

All of the base VectorStar (MS464xB) options are available with the ME7848A/E series systems. These include:

MS4640B-002	Time Domain
MS4640B-007	Receiver Offset
MS4640B-021	Universal Fixture Extraction
MS464xB-031	Dual Source Architecture
MS464xB-032	Internal RF combiner
MS4640B-035	IF Digitizer
MS4640B-041	Noise Figure
MS4640B-042	PulseView™
MS4640B-043	DifferentialView™
MS4640B-044	IMDView™
MS4640B-046	Fast CW
MS4640B-047	Eye Diagram
MS4640B-048	Differential Noise Figure
MS464xB-049	Spectrum Analysis
MS4640B-051	External VNA Direct Access Loops
MS4640B-053	External ALC
MS4640B-061	Active Measurement Suite, with 2 Step Attenuators
MS4640B-062	Active Measurement Suite, with 4 Step Attenuators
MS4640B-070	70 kHz Low End Frequency Extension
MS4640B-08x	Broadband/mmWave access and control

Generally, one of the looped options (51, 61, or 62) is required for 40 and 70 GHz systems, although the factory can be contacted for non-looped situations. Options 61 and 62 also include step attenuators which do affect minimum measurable response floors and maximum available RF power.

The ME7848A/E-02xx and -01xx choices denote full systems and those with only the VNA and the O/E calibration module, respectively. The full systems (Option -02xx) are tested as such. Full system testing is not offered with the -01xx systems, but based on individual component specifications, the system specifications in this document are expected to be met if the same model of E/O converter unit is employed (MN4775A-0040, -0070, -0071, -0072, -0110, or -0111) or a unit with equivalent performance. The use of other lasers or E/O modulators may provide similar results, but this technical data sheet will not directly apply.

3743AX/EX mmWave Module



3743AX mmWave Module

The 3743AX/EX Broadband mmWave module can be adapted to a waveguide band output by adding an available waveguide band adapter and mounting flange. VectorStar menus automatically configure the system frequencies incorporating the 3743AX/EX module for banded operation. Using the ME7848AX/EX modules provides the opportunity to sweep frequencies for broadband applications and quickly convert to waveguide configurations for banded measurements. The advantages of small compact modules with excellent RF performance and power range control can therefore be realized in both broadband and waveguide configurations when using the 3743AX/EX mmWave module. For systems where only waveguide band operation is required, the 3744A-EE or 3744A-EW mmWave module can be used.

36585-Series Automatic Calibrators (AutoCal)

The 36585-Series Precision Automatic Calibrator (AutoCal) Module provides industry-leading performance in corrected characteristics using over-determined algorithms, and transferring characteristics from a highly accurate LRL type calibration. The resulting accuracies will even out perform a Sliding Load SOLT calibration. In order to remove the effects of matched adapters, the Precision 36585-Series AutoCal comes in a variety of connector gender types (m-m, f-f, and m-f). Adapter Removal Calibration routine is still available in the VectorStar software. With coverage from 70 kHz to 70 GHz, the 36585-series Precision AutoCal offers not only the fastest and most reliable calibration, but also the most accurate broadband coaxial VNA calibration method.



36585V Series Precision AutoCal Module

36585 Series Precision AutoCal Calibration Kit

Description	Additional Information	Part Number
Precision AutoCal, K 70 kHz to 40 GHz, 2-port	K (male) to K (male)	36585K-2M
	K (female) to K (female)	36585K-2F
	K (male) to K (female)	36585K-2MF
Precision AutoCal, V 70 kHz to 70 GHz, 2-port	V (male) to V (male)	36585V-2M
	V (female) to V (female)	36585V-2F
	V (male) to V (female)	36585V-2MF

AutoCal General and Environmental

36581-Series Dimensions	65 mm H x 155 mm W x 90 mm D body (excluding connectors)
36585-Series Dimensions	42 mm H x 64 mm W x 140 mm D body (excluding connectors)
Control	Serial RS-232 control by the VNA via supplied 9-pin D-Sub cable (allowing forward-compatibility to legacy AutoCal)
Power	DC powered via supplied universal 110/220 V AC/DC adapter (with enough power to maintain optimum stability)
Operating Temperature	18 to 28 °C
Storage Temperature	-20 to 70 °C
Relative Humidity	5 % to 95 % at 40 °C, Non-condensing
EMI	Conforms to and meets the requirements of:
EMC Directive	2004/108/EC
Low Voltage Directive	2006/95/EC
Emissions	EN55011:2009+A1:2010 Group 1 Class A
Immunity	EN 61000-4-2:2009, 4 kV CD, 8 kV AD
	EN 61000-4-3:2006+A2:2010, 3 V/m
	EN 61000-4-4:2004, 0.5 kV S-L, 1 kV P-L
	EN 61000-4-5:2006, 0.5 kV S-L, 1 kV L-E
	EN 61000-4-6:2009, 3 V
	EN 61000-4-11:2004, 100 % @ 20 ms

Mechanical Calibration Kits

SMA/3.5 mm Calibration Kit, 3650A Series

3650A cal kit provides 50 Ω calibrations for 3.5 mm or SMA devices using 3.5 mm standards. 3650A-1 cal kit includes Sliding Loads.

3650A Cal Kit contains:	Additional Information (typical)	Quantity	Part Number
Termination 3.5 mm (male)	Return Loss: > 37 dB ($F \leq 18.5$ GHz)	2	28S50-2
Termination 3.5 mm (female)	> 30 dB ($F > 18.5$ GHz)	2	28SF50-2
Open 3.5 mm (male)	Offset: 5 mm	1	24S50
Open 3.5 mm (female)	Offset: 5 mm	1	24SF50
Short 3.5 mm (male)	Offset: 5 mm	1	23S50
Short 3.5 mm (female)	Offset: 5 mm	1	23SF50
Adapter, 3.5 mm (male) to 3.5 mm (male)		1	33SS50
Adapter, 3.5 mm (female) to 3.5 mm (female)		2	33SFSF50
Adapter, 3.5 mm (male) to 3.5 mm (female)		2	33SSF50
Torque Wrench	5/16 in, 0.9 N-m (8 lbf-in)	1	01-201
Wrench, Universal	For SMA, 3.5 mm, 2.4 mm, K and V Connectors	1	01-204
Pin Depth Gauge		1	01-222
Adapter (female) for Pin Gauge		1	01-223
Reference Flat		1	01-210
Connector Thumb Wheel		4	A18311
Coefficients for standards	Provided on a memory device and 3.5 in floppy disk	1	-
3650A-1 Cal Kit adds:	Additional Information (typical)	Quantity	Part Number
Sliding Termination 3.5 mm (male)		1	17S50
Sliding Termination 3.5 mm (female)		1	17SF50
Flush Short (male)		1	01-211
Flush Short (female)		1	01-212

K (2.92 mm) Calibration Kit, 3652A Series

3652A cal kit provides 50 Ω calibrations for K devices.

3652A Cal Kit contains:	Additional Information (typical)	Quantity	Part Number
Termination K (male)	Return Loss: > 34 dB ($F \leq 18.5$ GHz)	2	28K50A
Termination K (female)	> 32 dB ($F \leq 40$ GHz)	2	28KF50A
Open K (male)	Offset: 5 mm	1	24K50
Open K (female)	Offset: 5 mm	1	24KF50
Short K (male)	Offset: 5 mm	1	23K50
Short K (female)	Offset: 5 mm	1	23KF50
Adapter, K (male) to K (male)		1	33KK50B
Adapter, K (female) to K (female)		2	33KFKF50B
Adapter, K (male) to K (female)		2	33KKF50B
Torque Wrench	5/16 in, 0.9 N-m (8 lbf-in)	1	01-201
Wrench, Universal	For SMA, 3.5 mm, 2.4 mm, K, and V Connectors	1	01-204
Pin Depth Gauge		1	01-222
Adapter (female) for Pin Gauge		1	01-223
Reference Flat		1	01-210
Connector Thumb Wheel		4	A18311
Coefficients for standards	Provided on a USB memory device and 3.5 in floppy disk	1	-

K (2.92 mm) Calibration Kit, 3652A Series (continued)

Additional Information (typical)	Quantity	Part Number
3652A-2 Cal Kit adds:		
No Additional Options	NA	NA
Removes Pin Depth Gauge	NA	01-222
Removes Female Adapter for Pin Depth Gauge	NA	01-223
Removes Reference Flat	NA	01-210
3652A-3 Cal Kit adds:		
.s1p Characterization	1	NA
3652A-4 Cal Kit adds:		
.s1p Characterization	1	NA
Removes Pin Depth Gauge	NA	01-222
Removes Female Adapter for Pin Depth Gauge	NA	01-223
Removes Reference Flat	NA	01-210

V (1.85 mm) Calibration Kit, 3654D Series



3654D Series, V (1.85 mm) Calibration Kit

3654D cal kit provides 50 Ω calibrations for V devices.

3654D Cal Kit contains:	Additional Information (typical)	Quantity	Part Number
Termination V (male)	Return Loss: > 40 dB (F ≤ 20 GHz); > 35 dB (F ≤ 40 GHz)	2	28V50D
Termination V (female)	> 32 dB (F ≤ 67 GHz); > 28 dB (F ≤ 70 GHz)	2	28VF50D
Open V (male)	Offset: 4.75 mm	1	24V50C
Open V (female)	Offset: 4.75 mm	1	24VF50C
Short V (male)	Offset: 5.1 mm	1	23V50C
Short V (female)	Offset: 5.1 mm	1	23VF50C
Adapter, V (male) to V (male)		1	33VV50C
Adapter, V (female) to V (female)		2	33VVF50C
Adapter, V (male) to V (female)		2	33VVF50C
Torque Wrench	5/16 in, 0.9 N·m (8 lbf·in)	1	01-201
Wrench, Universal	For SMA, 3.5 mm, 2.4 mm, K, and V Connectors	1	01-204
Pin Depth Gauge		1	01-322
Adapter (female) for Pin Gauge		1	01-323
Reference Flat		1	01-210
Connector Thumb Wheel		4	A18311
Coefficients for standards	Provided on a USB memory device and 3.5 in floppy disk	1	-
3654D-2 Cal Kit adds:		Quantity	Part Number
No Additional Options		NA	NA
Removes Pin Depth Gauge		NA	01-322
Removes Female Adapter for Pin Depth Gauge		NA	01-323
Removes Reference Flat		NA	01-210
3654D-3 Cal Kit adds:		Quantity	Part Number
.s1p Characterization		1	NA
3654D-4 Cal Kit adds:		Quantity	Part Number
.s1p Characterization		1	NA
Removes Pin Depth Gauge		NA	01-322
Removes Female Adapter for Pin Depth Gauge		NA	01-323
Removes Reference Flat		NA	01-210

V (1.85 mm) Multi-Line Calibration Kit, 3657 Series

The 3657 Calibration Kit provides 50 Ω beadless V (male to male) lines for metrology applications. The 3657-1 Calibration Kit includes Shorts for LRL-type coaxial calibrations.



3657 Series, V (1.85 mm) Multi-Line Calibration Kit

3657 Cal Kit contains:		Additional Information (typical)	Quantity	Part Number
Line 1	Electrical Length = 15 mm; 50 Ω	Center Conductor	1	65899-1
		Outer Conductor	1	65898-1
Line 2	Electrical Length = 16.7 mm; 50 Ω	Center Conductor	1	65899-2
		Outer Conductor	1	65898-2
Line 3	Electrical Length = 18.4 mm; 50 Ω	Center Conductor	1	65899-3
		Outer Conductor	1	65898-3
Line 4	Electrical Length = 20.1 mm; 50 Ω	Center Conductor	1	65899-4
		Outer Conductor	1	65898-4
Line 5	Electrical Length = 21.8 mm; 50 Ω	Center Conductor	1	65899-5
		Outer Conductor	1	65898-5
Line 6	Electrical Length = 49.84 mm; 50 Ω	Center Conductor	1	65899-6
		Outer Conductor	1	65898-6
Tool, Center Conductor Removal Plug			1	65922
Fixture, Center Conductor Installation, Short		For Lines 1 to 5	1	65901-1
Fixture, Center Conductor Installation, Long		For Line 6	1	65901-6
Open-Ended Wrench		7 mm	1	783-1243
Torque Wrench		5/16 in, 0.9 N·m (8 lbf·in)	1	01-201
3657-1 Cal Kit adds:		Additional Information (typical)	Quantity	Part Number
Short V (male)		Offset: 5.1 mm	2	23V50B
Short V (female)		Offset: 5.1 mm	2	23VF50B

W1 (1 mm) Calibration/Verification Kit, 3656C

Provides 12-term SOLT or Triple Offset Short calibrations, for W1 1 mm devices, and two verification standards.

The standard 3656C and 3656C-3 kits include calibration and verification (18WWF50A-1 and -1B) components and verification characterization data. The 3656C-5 and 3656C-6 kits include only the calibration components. 3656C-3 and 3656C-6 kits have the calibration components defined with .s1p (tabular) files as well as with the model-based .cfc files.



3656C W1 1 mm Calibration/Verification Kit providing 12-Term SOLT or SSST calibrations and two verification standards.

3656C Cal Kit Contents	Additional Information (Typical)	Quantity	Part Number
Offset Short W1 (male)	Offset: 2.020 mm	1	23W50-1
Offset Short W1 (male)	Offset: 2.650 mm	1	23W50-2
Offset Short W1 (male)	Offset: 3.180 mm	1	23W50-5
Offset Short W1 (female)	Offset: 2.020 mm	1	23WF50-1
Offset Short W1 (female)	Offset: 2.650 mm	1	23WF50-2
Offset Short W1 (female)	Offset: 3.180 mm	1	23WF50-5
Open W1 (male)	Offset: 1.510 mm		24W50
Open W1 (female)	Offset: 1.930 mm	1	24WF50
Fixed Termination W1 (male)		1	28W50
Fixed Termination W1 (female)		1	28WF50
Adapter, W1 (male) to Fixed SC ^a Connector		1	33WSC50
Adapter, W1 (female) to Fixed SC ^a Connector		1	33WFSC50
Interchangeable Slider for SC ^a Connector (male)		1	-
Interchangeable Slider for SC ^a Connector (female)		1	-
Locking Keys for SC ^a Connectors		1	-
Pin Exchange Tool for SC ^a Connectors	Contains 1 male pin	1	01-402
Adapter, W1 (male) to W1 (female)		1	33WWF50A
Adapter, W1 (male) to W1 (male)		1	33WW50A
Adapter, W1 (female) to W1 (female)		1	33WFWF50A
Stepped Impedance ThruLine, W1 (male - female)	Verification Device	1	18WWF50A-1B
50 Ohm matched ThruLine, W1 (male - female)	Verification Device	1	18WWF50A-1
Torque Wrench	6 mm, 5.4 N-cm (4 lbf-in)	1	01-504
Open-ended Wrench	6 mm / 7 mm	1	01-505
Coefficients for Standards	On USB Memory Device		-

a. SC connectors are a solution for accurate calibrations for non-insertable 1 mm devices. Users can change the gender of the SC connector using the provided tool, pin, sliders, and locking keys to ensure the best pin-depth, thus calibrations are valid after changing the gender of the adapter.

Test Port Cables

3670-Series Test Port Cables, Ruggedized Semi-Rigid, up to 70 GHz

Note: Connector torque for 3670-Series cables is 8 lbf-in (0.9 N·m).

Description	Frequency Range	Nominal Impedance	Insertion Loss (dB, typical)	Return Loss (dB, typical)	Length	Part Number
K (female) to K (male)	DC to 40 GHz	50 Ω	2.3 dB/m @ 20 GHz 4.7 dB/m @ 40 GHz	≥ 16	30.5 cm (12 in)	3670K50-1
					61.0 cm (24 in)	3670K50-2
V (female) to V (male)	DC to 70 GHz	50 Ω	3.6 dB/m @ 20 GHz 5.2 dB/m @ 40 GHz 7.2 dB/m @ 70 GHz	≥ 16	30.5 cm (12 in)	3670V50A-1
					61.0 cm (24 in)	3670V50A-2



70 GHz Phase Stable Flexible Test Port Cables, 3671-Series



70 GHz Ruggedized Semi-Rigid Test Cables, 3670-Series

3671-Series Test Port Cables, Flexible, Phase Stable, up to 70 GHz

Note: Connector torque for 3671-Series cables (70 GHz and below models) is 0.9 N·m (8 lbf-in). For W connectorized versions, the connector torque is 0.45 N·m (4 lbf-in).

Description	Frequency Range	Nominal Impedance	Insertion Loss (dB, f in GHz)	Return Loss (dB)	Phase Stability (± degrees, f in GHz)	Length	Part Number
K (female) to 3.5 mm (male)	DC to 26.5 GHz	50 Ω	≤ 1.8	≥ 18	± 4.0 (1 coil)	60 cm (23.5 in)	3671KF50-60
K (female) to K (male or female)	DC to 40 GHz	50 Ω	≤ 3.4	≥ 16	± 3.7 (1/2 coil)	60 cm (23.5 in)	3671KFK50-60
K (female) to K (male)	DC to 40 GHz	50 Ω	≤ 5.0	≥ 16	± 7.3 (1 coil)	100 cm (39.3 in)	3671KFK50-100
K (female) to K (female)	DC to 40 GHz	50 Ω	≤ 3.4	≥ 16	± 3.7 (1/2 coil)	60 cm (23.5 in)	3671KFKF50-60
V (female) to V (male)	DC to 70 GHz	50 Ω	≤ 6.0	≥ 14	± 8.5 (1/2 coil)	60 cm (23.5 in)	3671VVF50-60
V (female) to V (male)	DC to 70 GHz	50 Ω	≤ 9.3	≥ 14	± 10.5 (1 coil)	100 cm (39.3 in)	3671VVF50-100

Tools

- 01-201 Torque End Wrench, 5/16 in, 0.9 N·m (8 lbf-in), For tightening male devices, For SMA, 3.5 mm, 2.4 mm, K, and V connectors.
- 01-202 Torque End Wrench, 1/2 in, 60 lbf-in, For servicing the universal test port, For the removal or installation of a test port.
- 01-203 Torque End Wrench, 20.6 mm (13/16 in), 0.9 N·m (8 lbf-in), For tightening the VNA test ports to female devices.
- 01-204 End Wrench, 5/16 in, Universal, Circular, Open-ended, For SMA, 3.5 mm, 2.4 mm, K and V connectors.
- 01-504 Torque End Wrench, 6 mm, 0.45 N·m (4 lbf-in), For tightening 1 mm (W) connectors.
- 01-505 6 mm × 7 mm Open End Wrench, Backing wrench for 6 mm torque wrench (above) for 1 mm (W) connectors.
- 01-529-R Torque End Wrench, 4 mm (5/32 in), 0.17 N·m (1.5 lbf-in), For tightening the SSMC TEST and REF connectors on mmWave Modules.

Test Port Cables, Flexible, Ruggedized-Style Female Connectors, Phase Stable

Ruggedized style female connectors for VNA test ports.

3671KFS50-60	K (female) to 3.5 mm (male), 1 each 63.5 cm (25 in) Note: Due to length, two (2) cables are required for each system
3671KFK50-60	K (female) to K (male), 1 each, 63.5 cm (25 in) Note: Due to length, two (2) cables are required for each system
3671KFK50-100	K (female) to K (male), 1 each, 96.5 cm (38 in)
3671KFKF50-60	K (female) to K (female), 1 each 63.5 cm (25 in) Note: Due to length, two (2) cables are required for each system
3671KFK50-60	K (female) to K (male), 1 each 63.5 cm (25 in) Note: Due to length, two (2) cables are required for each system
3671VVF50-60	V (female) to V (male), 1 each, 63.5 cm (25 in), rated to 70 GHz Note: Due to length, two (2) cables are required for each system
3671VVF50-100	V (female) to V (male), 1 each 96.5 cm (38 in), rated to 70 GHz

Test Port Cables, Flexible, High Performance

Description	Frequency Range	Impedance	3671W1-50-X		Return Loss [dB]	Part Number
			Length [cm]	Insertion Loss [dB]		
W1 (1 mm) (male) to W1 (1 mm) (female)	DC to 110 GHz	50 Ω	10	1.74	≥ 14	3671W1-50-1
			13	2.23	≥ 14	3671W1-50-2
			16	2.74	≥ 14	3671W1-50-3



3671W1-50-X Flexible Test Port Cables

Description	Frequency Range	Impedance	3670.850-X		Return Loss [dB]	Part Number
			Length [cm]	Insertion Loss [dB]		
1.0 mm (male) 1.0 mm (female)	DC to 110 GHz (125 GHz)	50 Ω	10	(2.5 at 125 GHz)	>=18 dB under 15 GHz >=16 dB for 15-50 GHz >=12 dB for 50 to 110 GHz (>=12 dB for 110 to 125 GHz)	3670W50-1
			16	(3.5 dB at 125 GHz)	>=18 dB under 15 GHz >=16 dB for 15-50 GHz >=12 dB for 50 to 110 GHz (>=12 dB for 110 to 125 GHz)	3670W50-2



3670W50-X 1 mm Test Port Cables

GPIB Cables

2100-5-R	GPIB Cable, 0.5 m long
2100-1-R	GPIB Cable, 1 m long
2100-2-R	GPIB Cable, 2 m long
2100-4-R	GPIB Cable, 4 m long

 Separately-orderable Accessory Kit Items

2000-1963-R	40 GHz Semi-rigid Cable Set
2000-1964-R	70 GHz Semi-rigid Cable Set
808-20-R	850 nm, 1 m, Patch Cable
808-21-R	1310/1550 nm, 1 m, Patch Cable

 Documentation

User Documentation:	All manuals are available as free downloads at www.anritsu.com .
10410-00317	MS4640B Series VNA Operation Manual (OM)
10410-00318	MS4640B Series VNA Calibration and Measurement Guide (MG)
10410-00319	MS4640B Series VNA User Interface Reference Manual (UIRM)
10410-00320	MS4640B Series VNA Maintenance Manual (MM)
10410-00322	MS4640B Series VNA Programming Manual (PM), for IEEE 488.2, System, and SCPI Commands
10410-00323	MS4640B Series VNA Programming Manual Supplement (PMS), for Lightning 37xxxx and HP8510 Emulation
10410-00742	MN4765B O/E Calibration Module Operating Manual
10410-00777	ME7848A/E ONA Quick Start Guide
10410-00778	ME7848A/E ONA Maintenance Manual
10410-00779	MN4775A E/O Converter Quick Start Guide
10410-00774	MN4775A E/O Converter Operations Manual
11410-01144	MN4775A E/O Converter Technical Data Sheet
11410-02825	ME7838AX/A4X-VectorStar-TDS
11410-02827	ME7838EX/E4X-VectorStar-TDS

 Extended Service

Extended service options are available on the underlying VNA and for certain other components. Consult Anritsu for additional information.

Training at Anritsu

Anritsu has designed courses to help you stay up to date with technologies important to your job. For available training courses, visit: www.anritsu.com and search for training and education.



• United States

Anritsu Americas Sales Company
450 Century Parkway, Suite 190,
Allen, TX 75013, U.S.A.
Phone: +1-800-Anritsu (1-800-267-4878)

• Canada

Anritsu Electronics Ltd.
Americas Sales and Support
450 Century Parkway, Suite 190,
Allen, TX 75013, U.S.A.
Phone: +1-800-Anritsu (1-800-267-4878)

• Brazil

Anritsu Elettronica Ltda.
Praça Amadeu Amaral, 27 - 1 Andar
01327-010 - Bela Vista - Sao Paulo - SP, Brazil
Phone: +55-11-3283-2511
Fax: +55-11-3288-6940

• Mexico

Anritsu Company, S.A. de C.V.
Blvd Miguel de Cervantes Saavedra #169 Piso 1,
Col. Granada, Mexico, Ciudad de Mexico,
11520, MEXICO
Phone: +52-55-4169-7104

• United Kingdom

Anritsu EMEA Ltd.
200 Capability Green,
Luton, Bedfordshire, LU1 3LU, U.K.
Phone: +44-1582-433200
Fax: +44-1582-731303

• France

Anritsu S.A.
12 avenue du Québec, Immeuble Goyave,
91140 VILLEBON SUR YVETTE, France
Phone: +33-1-60-92-15-50

• Germany

Anritsu GmbH
Nemetschek Haus, Konrad-Zuse-Platz 1,
81829 München, Germany
Phone: +49-89-442308-0
Fax: +49-89-442308-55

• Italy

Anritsu S.r.l.
Spaces Eur Arte, Viale dell'Arte 25, 00144 Roma, Italy
Phone: +39-6-509-9711
List Revision Date: 20230901

• Sweden

Anritsu AB
Kistagången 20 B, 2 tr, 164 40 Kista, Sweden
Phone: +46-8-534-707-00

• Finland

Anritsu AB
Technopolis Aviapolis, Teknobulevardi 3-5 (D208.5),
FI-01530 Vantaa, Finland
Phone: +358-20-741-8100

• Denmark

Anritsu A/S
c/o Regus Winghouse, Ørestads Boulevard 73, 4th floor,
2300 Copenhagen S, Denmark
Phone: +45-7211-2200

• Spain

Anritsu EMEA Ltd.
Representation Office in Spain
Paseo de la Castellana, 141.
Planta 5, Edificio Cuzco IV
28046, Madrid, Spain
Phone: +34-91-572-6761

• Austria

Anritsu EMEA GmbH
Am Belvedere 10, A-1100 Vienna, Austria
Phone: +43-(0)1-717-28-710

• United Arab Emirates

Anritsu EMEA Ltd.
Anritsu A/S
Office No. 164, Building 17, Dubai Internet City
P. O. Box - 501901, Dubai, United Arab Emirates
Phone: +971-4-3758479

• India

Anritsu India Private Limited
6th Floor, Indiqube ETA, No.38/4, Adjacent to EMC2,
Doddanekundi, Outer Ring Road,
Bengaluru - 560048, India
Phone: +91-80-6728-1300
Fax: +91-80-6728-1301

• Singapore

Anritsu Pte. Ltd.
1 Jalan Kilang Timor, #07-04/06 Pacific Tech Centre
Singapore 159303
Phone: +65-6282-2400
Fax: +65-6282-2533

• Vietnam

Anritsu Company Limited
16th Floor, Peakview Tower, 36 Hoang Cau Street,
O Cho Dua Ward, Dong Da District, Hanoi, Vietnam
Phone: +84-24-3201-2730

• P.R. China (Shanghai)

Anritsu (China) Co., Ltd.
Room 2701-2705, Tower A, New Caohejing
International Business Center No. 391 Gui Ping Road
Shanghai, 200233, P.R. China
Phone: +86-21-6237-0898
Fax: +86-21-6237-0899

• P.R. China (Hong Kong)

Anritsu Company Ltd.
Unit 1006-7, 10/F., Greenfield Tower, Concordia Plaza,
No. 1 Science Museum Road, Tsim Sha Tsui East,
Kowloon, Hong Kong, P.R. China
Phone: +852-2301-4980
Fax: +852-2301-3545

• Japan

Anritsu Corporation
8-5, Tamura-cho, Atsugi-shi, Kanagawa, 243-0016 Japan
Phone: +81-46-296-6509
Fax: +81-46-225-8352

• South Korea

Anritsu Corporation, Ltd.
8F, A TOWER, 20, Gwacheondaero 7-gil, Gwacheon-si,
Gyeonggi-do, 13840, Republic of Korea
Phone: +82-2-6259-7300
Fax: +82-2-6259-7301

• Australia

Anritsu Pty. Ltd.
Unit 20, 21-35 Ricketts Road,
Mount Waverley, Victoria 3149, Australia
Phone: +61-3-9558-8177
Fax: +61-3-9558-8255

• Taiwan

Anritsu Company Inc.
7F, No. 316, Sec. 1, NeiHu Rd., Taipei 114, Taiwan
Phone: +886-2-8751-1816
Fax: +886-2-8751-1817