

MP1577A

SONET/SDH/PDH/DSn Analyzer



Comprehensive Testing of Core Networks from One Compact Portable Analyzer

Possible VC4-64c/OC-192c Measurements

The MP1577A analyzer is designed for construction and maintenance of SDH, SONET, PDH and DS_n equipment and networks.

The MP1577A is scalable from 1.5 Mbit/s to 10 Gbit/s, and perform SONET/SDH/PDH/DS_n tests such as concatenation mapping, tandem connection, APS switching time measurement.

The MP1577A has a built-in printer and a 3.5-inch floppy disk drive as standard output devices to print measurement results, and to save and read measurement data to and from the floppy disk (FD), which can also be read on an external PC. The user can also save screen data to the FD. The MP1577A has a "HELP" key function that explains operations, functions and connections.

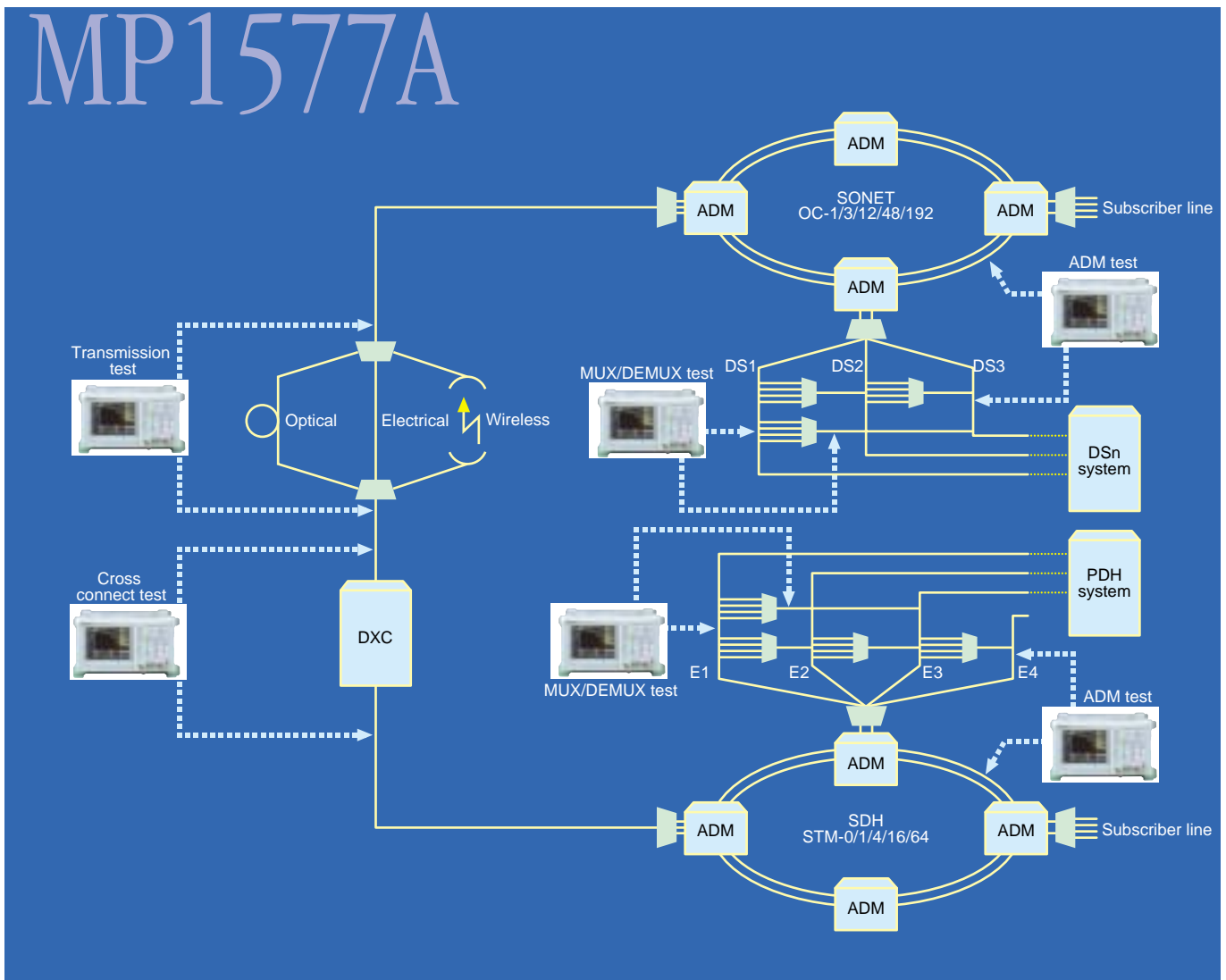

Conforming to Bit Rates from 1.5 Mbit/s to 10 Gbit/s in a Single Unit

The MP1577A conforms to ITU-T Rec. G.703 (2, 8, 34, 139, 1.5, and 45 Mbit/s), G.703 and G.958 (52, 156, 622, 2,488, and 9,953 Mbit/s), and allows the user to select plug-in units for different applications, including SONET, SDH, PDH, DS_n tests.

Concatenation Mapping

The MP1577A can perform SDH and SONET tests through the mapping routes from VC4 to VC4-64c and can also core router interface tests.

Enhanced SDH and SONET Test Functions

The MP1577A can generate and detect Tandem Connection patterns (ITU-T Rec. G.707). Also, APS switching time testing (ITU-T Rec. G.707, G.783, and G.842), and Alarm detection are supported.

Enhanced Through-Modes

The MP1577A enables the user to select one of the three different types of through-modes that it offers: (1) Transparent, (2) Overhead Overwrite, and (3) Payload Overwrite. The user can also insert various errors and alarms into the through signals.

Error Analysis (Error Performance)

The MP1577A enables the user to perform error measurement conforming to ITU-T Rec. G.821, G.826, M.2100, M.2101, M.2110, and M.2120.

Frequency and Optical Power Measurements

The MP1577A can measure received frequencies and display measurement results in a graph. If an optical interface plug-in unit is installed, the MP1577A can measure the absolute and relative values of the optical power.

Supports SDH, SONET, and Japan Mapping (Option) in One Frame

The MP1577A allows the user to set up the measurement of SDH, SONET, and 384k Japan mapping in one frame. The user can set a signalling pattern (multi-frame pattern of 8 frames or 64 frames) for Japan mapping measurement.

Jitter Generation and Measurement (Option 22, 23, 24)

The MP1577A can measure jitter tolerance and jitter transfer characteristics in conformance with ITU-T Rec. G.823/G.824/G.825/G.958, and Bellcore 253/499. It displays the measurement results as numeric values and as a graph, allowing the user to evaluate them easily.

Various wander generation functions

Various wander generations for evaluation are available: such as TDEV wander tolerance measurement and TDEV wander transfer characteristics measurement that were regulated by ITU-T, ANSI, Bellcore, and ETSI.

Variable-type TDEV wander generation: All 38 types of TDEV masks regulated by ITU-T, ANSI, Bellcore and ETSI are available as preset data. User-specified TDEV mask generation is also available.

Phase transient: Changes the phase by an inclination of $A(1 - e^{-63.7t})$. Moreover, the maximum phase shift quantity can be set freely. (A: maximum phase shift)

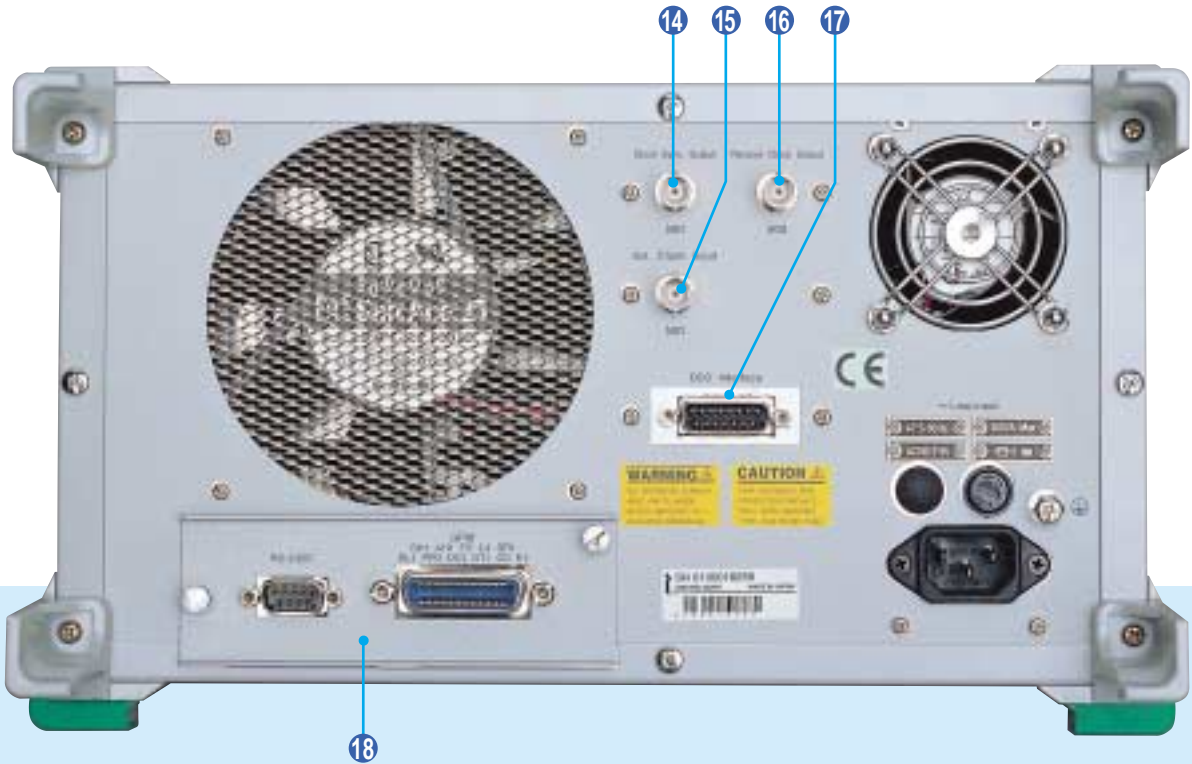
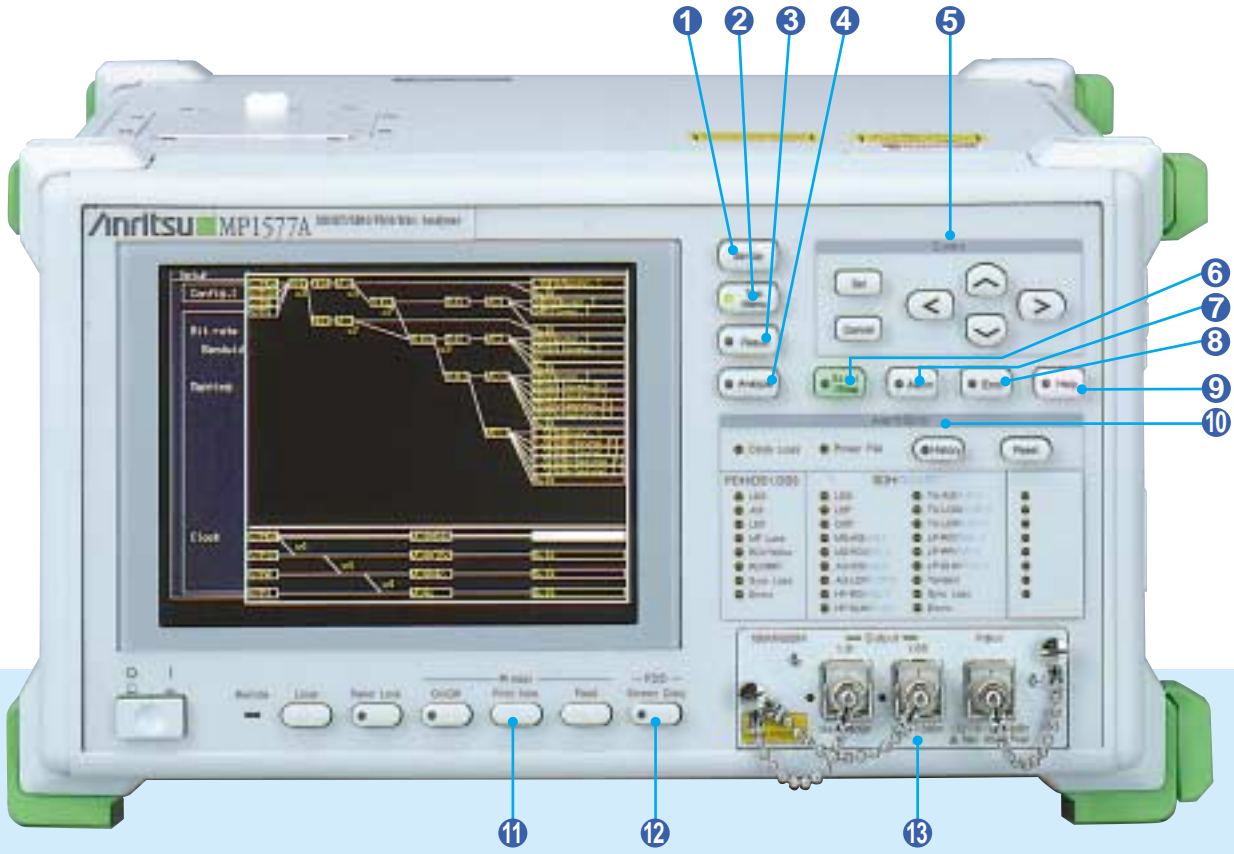

- 1 **Setup:** Displays setup screen
- 2 **Test Menu:** Displays main test menu screen
- 3 **Result:** Displays main measurement results screen
- 4 **Analyze:** Displays main analysis screen
- 5 **Cursor**
 - Set:** Sets data and opens windows for numeric, ASCII and character input
 - Cancel:** Cancels data setting and closes windows for numeric, ASCII and character input
 - ▲▼<>:** Move cursor or window cursor on screen. At the numeric input window, the ▲ and ▼ keys increase and decrease the numeric value, respectively.
- 6 **Start/Stop:** Starts and stops measurement
- 7 **Alarm:** Inserts alarms (The alarm target and additional method/timing are selected at the Manual screen.)
- 8 **Error:** Inserts errors (The error target and single/rate are selected at the Manual screen.)
- 9 **Help:** Displays help screen
- 10 **Alarm/Error:** Displays receiver alarms/errors, clock loss, and power fail measurement results
- 11 **Printer:** Prints screen at built-in or external printer
- 12 **Screen Copy:** Outputs screen in bitmap format to floppy disk

- 13 Slot for 156M/622M optical I/O
- 14 **Clock Sync Output:** Clock output synchronized with PDH or SDH send clock
- 15 **External Clock Input:** PDH or SDH external send clock input
- 16 **Receiver Clock Output:** Clock output synchronized with receiving data
- 17 **DCC Interface:** DCC clock output for send/receive, DCC data I/O connector
- 18 **External Interface:** Any of the RS-232C, GPIB, Ethernet interfaces can be selected as an option. In addition, an optional VGA output can be installed for connecting an external monitor.
- 19 Printer
- 20 Floppy disk drive
- 21 Slots for PDH/DSn units
- 22 2.5G/10G electrical/optical I/O
- 23 **DCS Input:** Data/clock input for SDH output synchronization
- 24 **Trigger Input:** Input for APS measurement and APS capture
- 25 **Trigger Output:** Output for error alarm detection, send/receive frame or clock
- 26 **Orderwire:** Modular jack for connecting orderwire headset

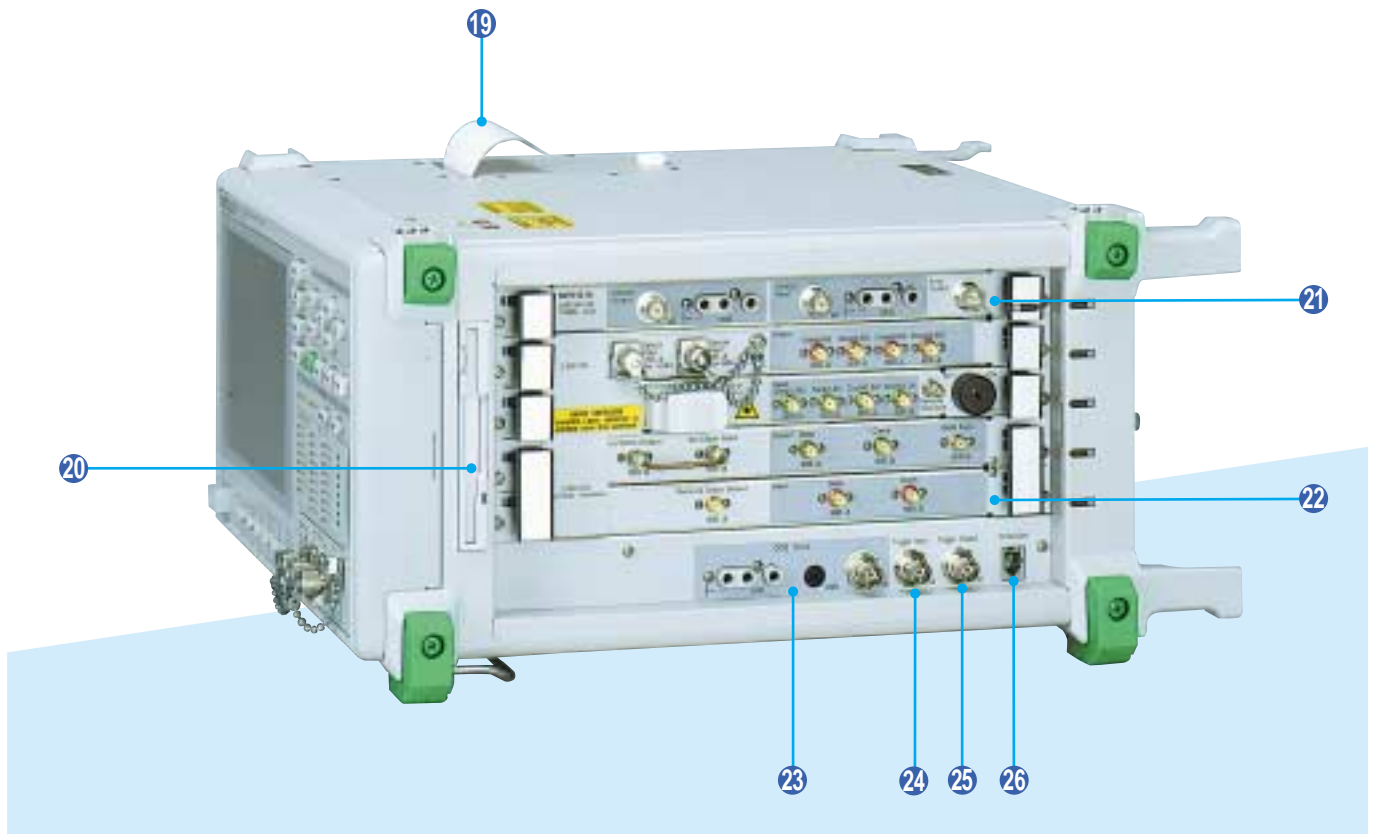

SDH, SONET, PDH and DS_n Measurement

Measurement at Bit Rates from 1.5 Mbit/s to 10 Gbit/s

A mapping route to a bit rate of up to 10 Gbit/s can be set. The MP1577A mainly supports SDH, SONET, Japan mapping, PDH of the European system and DS_n of the North American system for digital communications. For concatenation mapping, a route can be set from STM-1c up to STM-64c. Furthermore, the MP1577A supports a combination of channels. For example, 64 channels of VC4c, 16 channels of VC4-4c, and four channels of VC4-16c. (See figure 1 in page 14)



Mapping

Overhead Setting and Testing

The user can set the SOH, POH, all overheads and pass traces (J0, J1, J2). Moreover, monitors, such as SOH/POH (high order pass/low order pass), pointer and K1/K2 byte etc., are possible.



Overhead preset

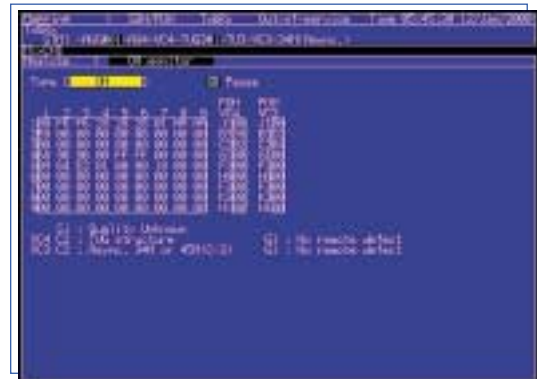

Overhead monitor

APS Function

The user can test the automatic protection switch (APS) by measuring the equipment switching time accurately in milliseconds. The MP1577A also conforms to ITU-T Rec. G.783 and G.841.



APS program data

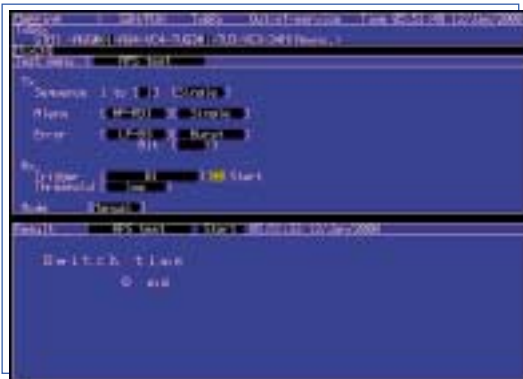

APS test sub-screen

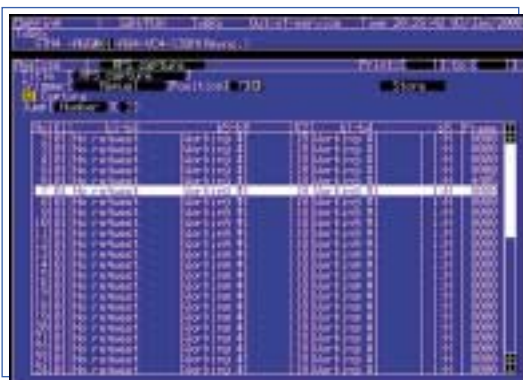

APS capture

Mixed Payload

At mapping measurement in TUG-3 and AU3, the user can set different mapping for three additional channels other than the target measurement channel.

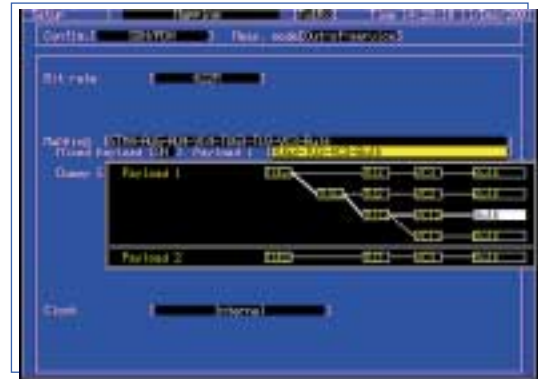

Mixed payload setting

Tandem Connection

The N1 and N2 bytes can be set and measured.

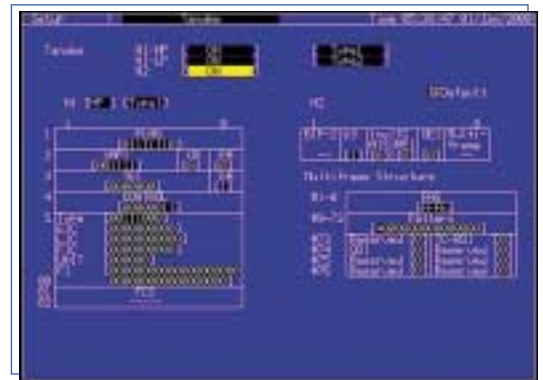

Tandem

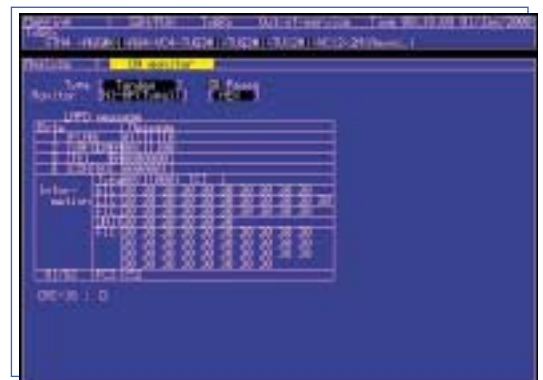

Overhead monitor (Tandem)

Various Analysis Functions

The internal optical power meter and frequency counter allows the user to measure optical power and frequency during error and alarm measurement. (Photo A)

Measured errors and alarms can be displayed as a graph with a time scale in 1 second, 1 minute, 15 minutes, or 60 minutes. (Photo B)



A: Optical power meter

Pointer Value Monitoring

Changes in pointer value can be displayed as a graph with values updated in real time.

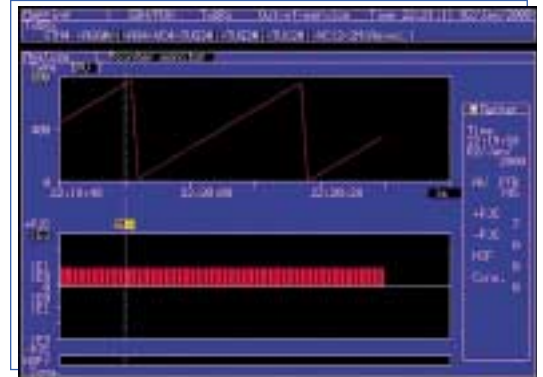

Pointer monitor

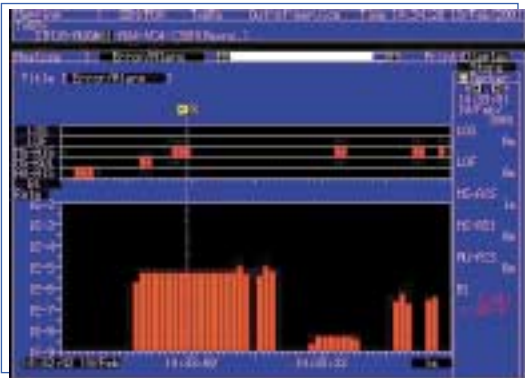

B: Error/alarm

MUX/DEMUX Function (Option)

When the MUX/DEMUX option is added, the multiplexing structure including the frame alignment signal can be generated, and multiplexer/demultiplexer measurement can be performed.

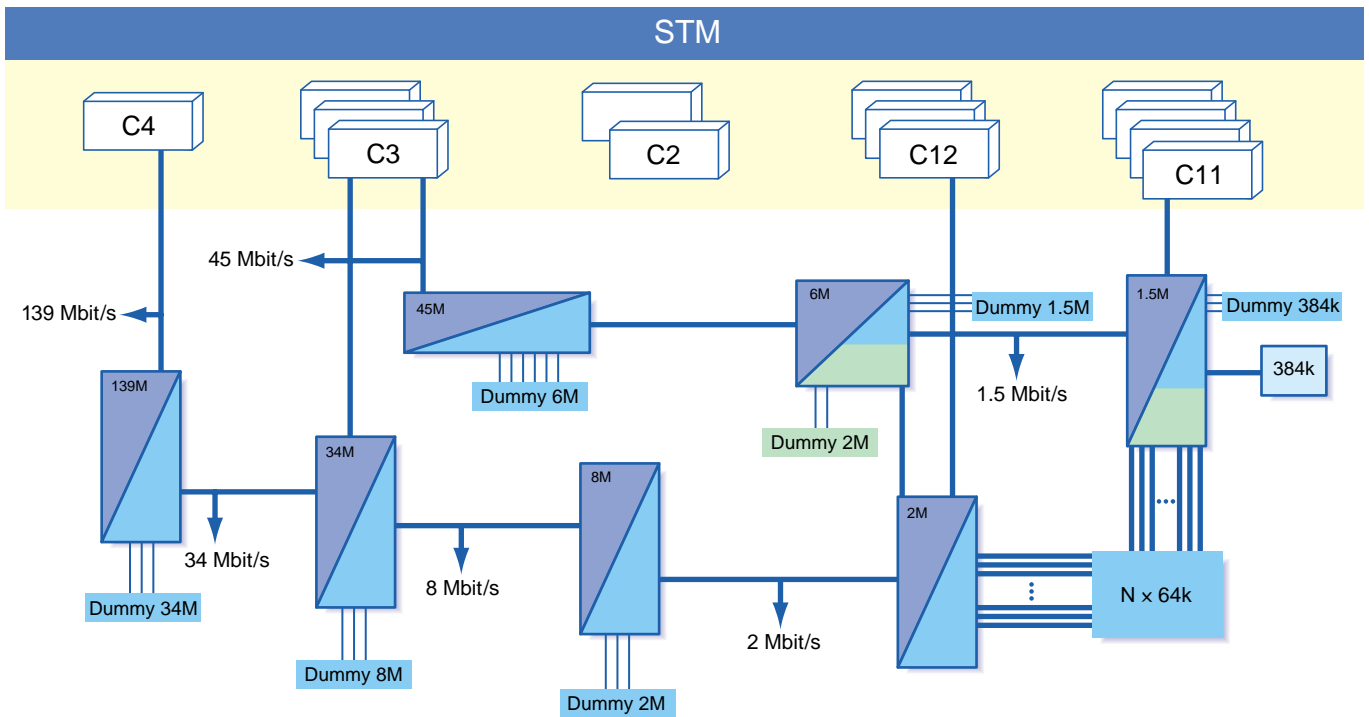

Through Modes

One of the three modes can be selected: (1) Transparent, (2) Overhead Overwrite, and (3) Payload Overwrite.

● Transparent

For in-service monitoring

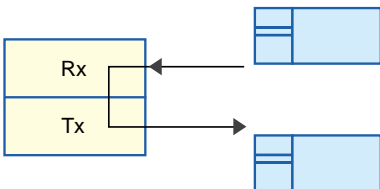

● Payload Overwrite

Insertion of internal STS-3SPE/VC4, VT6/TU2, VT2/TU12, VT1.5/TU11 signals

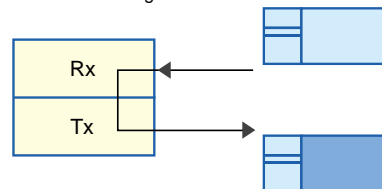

● Overhead Overwrite

Modification of SOH/POH byte. Addition of various errors/alarms.

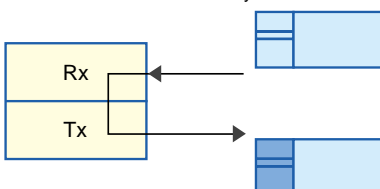

Enhanced Error/Alarm Simulation

The MP1577A can generate normal and abnormal frames alternately to test the frame synchronization function of terminal equipment. (This is an SDH FAS error addition function.)

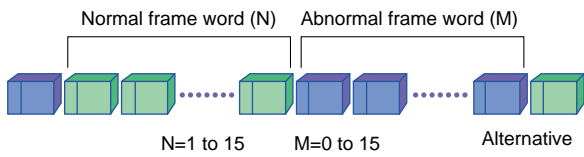

Example of FAS error

Jitter and Wander

Automatic Measurement with Easy-to-Understand Graphs

Jitter tolerance, jitter transfer and jitter frequency can all be measured automatically. And since the data can be saved to floppy disk in the text format, data management is made simple by using a personal computer. Masks conforming to ITU-T Rec. G.823/G.824/G.825/G.958 are provided as preset data. Measurement is performed simply by pressing the start key. Furthermore, the operator can also set any other mask as necessary.



Jitter transfer measurement that is able to set the selective bandwidth

In jitter standard such as ITU-T, ANSI, Bellcore, and ETSI, the bandwidth selective regulation is still unclear for jitter transfer measurement evaluation. This equipment selects the bandwidth selection at the jitter transfer measurement in the range of 1 to 30 Hz. It responds immediately when the standard such as ITU-T, is reconsidered.



Extended jitter quantity and frequency shift monitoring

Able to measure jitter/wander and error/alarm at the same time, so that the relationship of error/alarm generation and jitter can be analyzed.



Through jitter function (only SONET/SDH)

Able to generate the jitter by through, while monitoring the input jitter quantity.

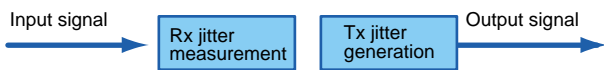

Mapping Jitter Measurement Method

Mapping jitter can be measured just by making a simple connection with the MP1577A.

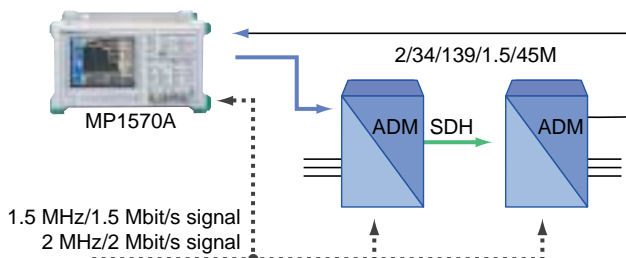

Variable-type jitter measurement filter based on DSP (up to 622 Mbit/s jitter measurement)

Filters regulated by ITU-T G series, such as ITU-T O.171/O.172, ANSI, Bellcore, and ETSI are available as preset data. The user can set the setting value of the filter freely and analyze the cause of jitter trouble.

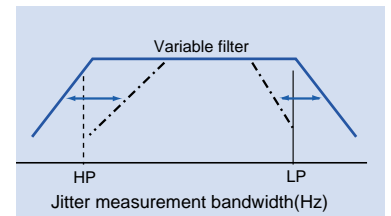

Wander Conforming to ITU-T Rec. G.823/G.824/G.825

Since MP1577A can generate wander [up to 57,600 Ulp-p/10 μHz (at 2488M)], jitter and wander tolerance mask evaluation conforming to ITU-T Rec. G.823/G.824/G.825 is possible. (usable wander tolerance mask at manual measurements)

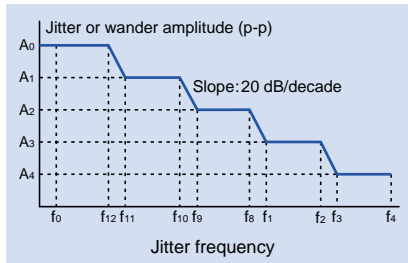

Various wander application software

It is possible to perform MTIE and TDEV measurements on real time by MX150001B wander application and external PC. Various wander measurements can also be performed, such as hold over, wander tolerance (TDEV), and wander transfer characteristics (TDEV).

Real time wander measurement: Real time wander measurements, such as frequency offset, frequency drift rate, MTIE, TIE, and TDEV

Wander tolerance (TDEV) measurement: Evaluates the wander tolerance by TDEV wander modulation

Wander transfer (TDEV) measurement: Evaluates the wander transfer characteristics by TDEV wander modulation

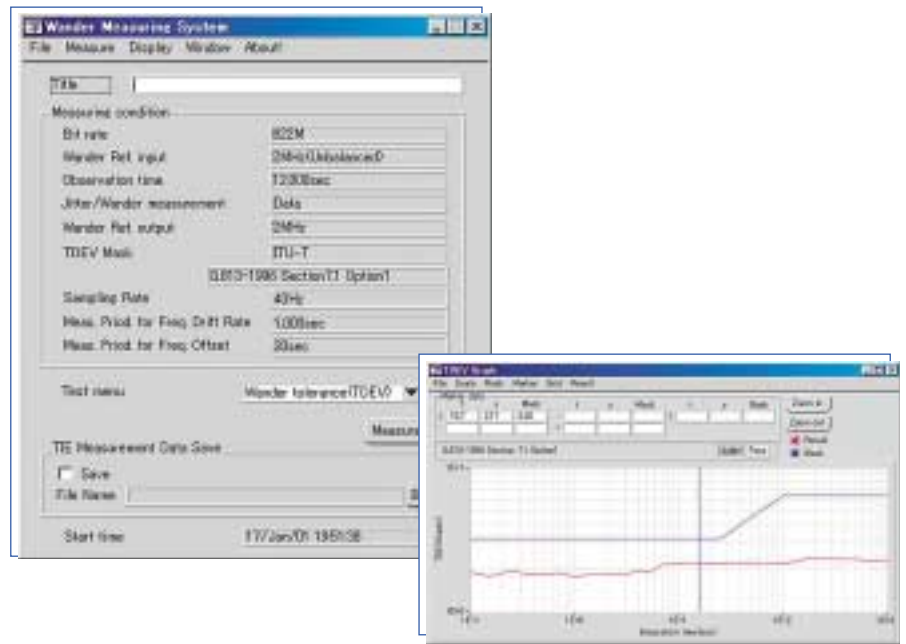

MTIE/TDEV Measurement

MTIE/TDEV analysis can be performed by running the MX150001B Application Software on an external personal computer. Data collected in the field can be saved to floppy disk and taken to the office for easy analysis and management on a computer.

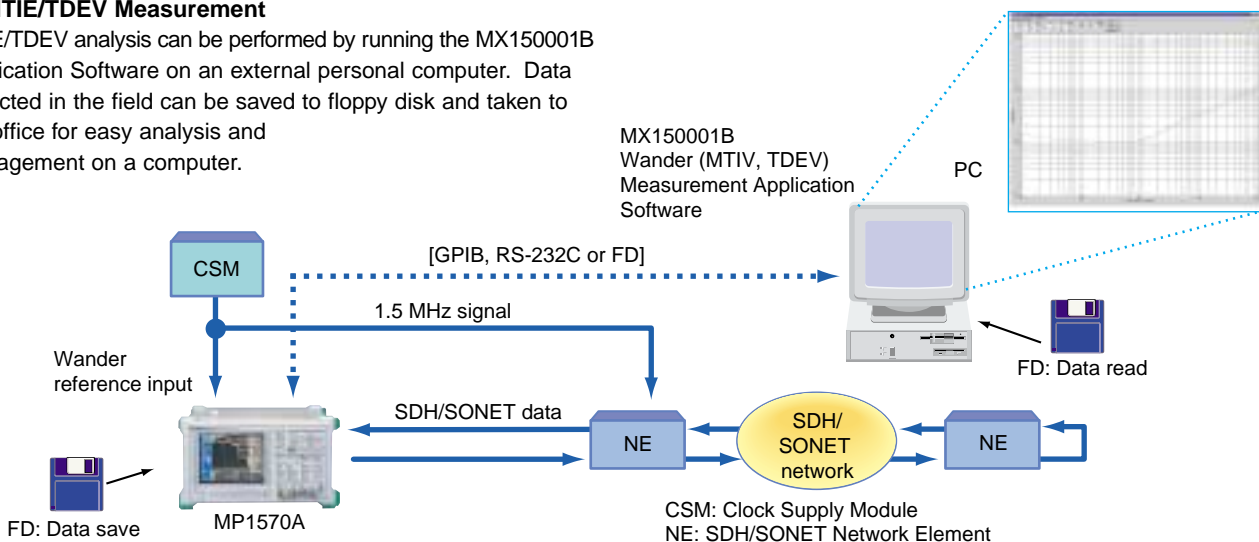

Specifications

• MP0121A 2/8/34/139/156M*1 Unit

Bit rate	2.048, 8.448, 34.368, 139.264 Mbit/s
Level/waveform	Conforms to ITU-T G.703 (with 20 dB monitoring point)
Connectors	BNC (75 Ω, unbalanced), 3-pin Siemens (120 Ω, balanced) 2.048 Mbit/s: HDB3 (balanced/unbalanced) 8.448, 34.368 Mbit/s: HDB3 (unbalanced) 139.264 Mbit/s: CMI (unbalanced)
Clock	Internal (accuracy: ±7 ppm), external (ECL [AC] 50 Ω), received signal
Frame format	Unframed: 2, 8, 34, 139 Mbit/s Framed: 2 Mbit/s (with/without CRC-4 at channels 30/31, G.704), 8 Mbit/s (G.742), 34 Mbit/s (G.751), 139 Mbit/s (G.751), MUX/DEMUX (Option 06)
Test patterns	PRBS: $2^{11} - 1$, $2^{15} - 1$, $2^{20} - 1$, $2^{23} - 1$ (O.151) Invert: On/off Word: 16-bit programmable, all 0, all 1
Error addition	Bit (all, test pattern), code, E-bit Timing: Single, rate (1E-3, 1E-4, 1E-5, 1E-6, 1E-7) FAS: n in 16 (n: 1 to 4), all
Alarm addition	LOS, LOF, AIS, RDI, RDI (MF) Timing: All
Measurements	Mode: Single, repeat, manual In-service Errors: Frame, code, CRC-4, E-bit Alarms: Power-fail, LOS, AIS, LOF, MF loss, RDI, RDI (MF) Error performance: G.821 (inc. Annex D), M.2100, G.826 Out-of-service Errors: Frame, code, CRC-4, E-bit, bit Alarms: Power-fail, LOS, AIS, LOF, MF loss, RDI, RDI (MF), sync loss Error performance: G.821 (inc. Annex D), M.2100, G.826
LEDs	LOS, AIS, LOF, MF loss, RDI, RDI (MF), sync loss, errors
Monitor	Frame word
Trouble search	Auto search for errors/alarms in all measured channels
Delay measurement	0 to 1 s
Auxiliary interface	Clock sync output, frame sync output, error output

*1: Built-in 156M CMI (electrical) interface

Can not be used simultaneously with the MP0122A or MP0122B.



• **MP0122A 1.5/45/52M*1 Unit, MP0122B 1.5/45/52/52M*2 (1.31) Unit**

Bit rate	1.544, 44.736 Mbit/s
Level/waveform	1.544 Mbit/s: ANSI T1.102 (with 20 dB monitoring point), 0/655 ft 44.736 Mbit/s: ANSI T1.102 (with 20 dB monitoring point), 0/450/900 ft
Connectors	BNC (75 Ω, unbalanced), Bantam (100 Ω, balanced) 1.544 Mbit/s: AML/B8ZS (balanced), 44.736 Mbit/s: B3ZS (unbalanced)
Clock	Internal (accuracy: ±7 ppm), external (ECL [AC] 50 Ω) received signal
Frame format	Unframed: 1.5, 45 Mbit/s Framed: 1.5 Mbit/s (D4, ESF, Japan ESF*3), 45 Mbit/s (M13, C-bit), MUX/DEMUX (Option 07)
Test patterns	PRBS: 2 ¹¹ - 1, 2 ¹⁵ - 1, 2 ²⁰ - 1 (zero suppress), 2 ²⁰ - 1, 2 ²³ - 1 (O.151) Invert: On/off Word: 16-bit program, all 0, all 1, 3 in 24 (1.5 Mbit/s)
Error addition	Bit (all, test pattern), code, parity, CRC-6, C-bit, REI Timing: Single, rate (1E-3, 1E-4, 1E-5, 1E-6, 1E-7) FAS (45 Mbit/s): n in 16 (n: 1 to 4), all
X-bit setting	00, 01, 10, 11
Alarm addition	LOS, LOF, AIS, RDI Timing: All
Measurements	Mode: Single, repeat, manual In-service Errors: FAS, code, parity, CRC-6, C-bit, REI Alarms: Power-fail, LOS, AIS, LOF, RDI Error performance: G.821 (inc. Annex D), G.826, M.2100 Out-of-service Errors: FAS, code, parity, CRC-6, C-bit, REI, bit Alarms: Power-fail, LOS, AIS, LOF, RDI, sync loss Error performance: G.821 (inc. Annex D), G.826, M.2100
LEDs	LOS, LOF, AIS, RDI, sync loss, errors
Trouble search	Auto search for errors/alarms in all measured channels
Delay measurement	0 to 1 s
Auxiliary interface	Clock sync output, frame sync output, error output

- *1: Built-in 52M B3ZS (electrical) interface
- *2: Built-in 52M B3ZS (electrical) and optical interfaces
- *3: Mounted Option 09 (Japan mapping)

Can not be used simultaneously with the MP0121A or MP0122B.



• **MP0122B 1.5/45/52/52M (1.31) Unit**

Optical interface

Bit rate	51.84 Mbit/s (NRZ)
Transmit	Wavelength: 1310 nm Output level: -11.5 dBm ±3.5 dB Optical safety: IEC 825-1 Class 1, 21CFR1040.10 Class I Connector: FC-PC (SM-F)
Receive	Sensitivity 52M: -33 to -8 dBm (test pattern: PRBS 2 ²³ - 1, BER 10 ⁻¹⁰ , +10° to +40°C) Connector: FC-PC (SM-F) Power measurement Measurement range: -30 to 0 dBm (peak power) Accuracy: ≤±1 dB (-20 dBm) Linearity: ≤±1 dB (-30 to 0 dBm) Monitor input Level: 0.1 to 1.0 Vp-p (AC), Connector: SMA (50 Ω)

Can not be used simultaneously with the MP0121A or MP0122A.



● 52/156/622/2488/9953M

Bit rate	51.84, 155.52, 622.08, 2488.32, 9953.28 Mbit/s
Level/waveform	52M (electrical: B3ZS)*1: ANSI T1.102, 0/450 ft 52M (optical): As per MP0122B unit optical interface specifications 156M (electrical: CMI)*2: ITU-T G.703 156M (optical): As per 156M/622M optical I/O specifications 622M (optical): As per 156M/622M optical I/O specifications 2488M (electrical/optical): As per 2.5G/10G electrical optical I/O specifications 9953M (electrical/optical): As per 2.5G/10G electrical optical I/O specifications
Clock	Internal (accuracy: ± 3.5 ppm), Lock (2 MHz, 1.5 MHz, 64 kHz + 8 kHz, 2 Mbit/s, 1.5 Mbit/s), external (ECL [AC] 50 Ω , 9953M: 1.02 to 0.58 Vp-p, 50 Ω), received signal
Frame	SDH/SONET
Mapping	See Fig. 1
Through	Transparent, overhead overwrite, payload overwrite
Test patterns	PRBS: 2 ¹¹ -1, 2 ¹⁵ -1, 2 ²⁰ -1 (zero suppress, MP0122A/B installed), 2 ²⁰ -1, 2 ²³ -1, 2 ³¹ -1 (only concatenation mapping 16c/64c, conform to O.151) Invert: On/off Word: 16-bit programmable, all 0, all 1
Error addition	Bit all (all, test pattern), FAS, B1, B2, B3, BIP-2, MS-REI, HP-REI, LP-REI Timing: Single, single (burst) bit (1 to 64000), rate (1E-3, 1E-4, 1E-5, 1E-6, 1E-7, 1E-8, 1E-9) User program AE-B [A: 1.0 to 9.9 (step: 0.1), B: 2 to 10] Alternative: Error frame (0 to 8000), normal frame (1 to 8000)
Alarm addition	LOS, LOF, MS-AIS, MS-RDI, AU-AIS, AU-LOP, HP-SLM, HP-TIM, HP-RDI, HP-UNEQ, TU-AIS, TU-LOP, TU-LOM, LP-SLM, LP-TIM, LP-RDI, LP-UNEQ, LP-RFI Timing: Single, single (burst) frame Alternative: Alarm frame (0 to 8000), normal frame (1 to 8000), all
Measurements	Mode: Single, repeat, manual In-service/Out-of-service Errors: B1, B2, B3, BIP-2, MS-REI, HP-REI, LP-REI Alarms: Power-fail, LOS, LOF, OOF, MS-AIS, MS-RDI, AU-AIS, AU-LOP, HP-SLM, HP-TIM, HP-RDI, HP-UNEQ, TU-AIS, TU-LOP, TU-LOM, LP-SLM, LP-TIM, LP-RDI, LP-UNEQ, LP-RFI Error performance: G.826, M2101, M2110, M2120 Preset: Alarm measurement condition
LEDs	LOS, LOF, OOF, MS-AIS, MS-RDI, AU-AIS, AU-LOP, HP-RDI, HP-SLM, TU-AIS, TU-LOM, TU-LOP, LP-RDI, LP-RFI, LP-SLM, Tandem, sync. loss, errors
Tandem connection	N1 byte (Type 1, Type 2), N2 byte Errors: N2 BIP-2, TC-REI, OEI, IEC Alarms: VC-AIS, ISF, FAS, HP-Incoming-AIS, HP-TC-RDI, HP-ODI, LP-Incoming-AIS, LP-TC-RDI, LP-ODI
Justification	AU pointer, TU pointer, C, C1/C2 Measurement: NDF, +PJC, -PJC, Cons, C, C1/C2
Monitor	SOH, POH, K1/K2, pointer, path trace (TIM alarms detectable), Tandem, payload
Dummy channel setting	Payload: Dummy, copy, mixed payload Setting: POH, pathtrace, Tandem
Simultaneous measurement	VC2, VC12, VC11
Trouble search	Auto search for errors/alarms in all measured channels
Delay	Measurement period: 0.5, 1, 2, 5, 10 s Measurement range: 0 to 999 μ s, 1.0 to 999.9 ms, 1.0 to 10.0 s, time out Display accuracy: ± 5 μ s (0.5, 1 s), ± 50 μ s (2, 5, 10 s)
APS (K1/K2)	Switching time measurement Measurement range: 1 to 2000 ms, >2000 ms Trigger Internal: B1, B2, B3, BIP-2, MS-REI, HP-REI, LP-REI, MS-AIS, AU-AIS, AU-LOP, HP-RDI, TU-AIS, TU-LOM, TU-LOP, LP-RDI, LP-RFI, Bit External: Measures trigger input signal (active high) Threshold: Specify non-error alarm between 1 ms, 10 ms, 100 ms Sequence generation: 2 to 64 word, repeat (8000 frame) Sequence capture: 2 to 64 word, repeat (8000 frame)
Frequency measurement	Range: ± 100 ppm, Accuracy: ± 3.5 ppm
Japan mapping (option 09)	VC11 Signaling (8-multiframe, 64-multiframe setting)
Payload offset	± 100 ppm/0.1 ppm step
Auxiliary interface	Clock sync output, trigger input, trigger output, DCC interface (V.11), orderwire, receive clock output

*1: Mounted MP0122A/B

*2: Mounted MP0121A

• General

Printer	Internal, external
Internal memory	Measurement settings memory: 10, Graphics memory: 15
Others	FDD, RS-232C (Option 01)*1, GPIB (Option 02)*1, Ethernet (Option 03)*1, video output (Option 04)*1, buzzer, clock, help, screen copy
EMC	EN61326: 1997/A1, 1998 (Class A) EN61000-3-2: 1995/A2, 1998 (Class A) EN61326: 1997/A1, 1998 (Annex A)
LVD	EN61010-1: 1993/A2, 1995 (Installation Category II, Pollution Degree 2)
Dimensions and mass	320 (W) x 177 (H) x 350 (D) mm, 15 kg approx.
Power	100 to 240 Vac, 47.5 to 63 Hz, ≤500 VA
Temperature	0° to +40°C

*1: The video output, RS-232C, GPIB and Ethernet options cannot all be used simultaneously.
Only the video output + RS-232C, or video output + GPIB, or RS-232C + GPIB board, or Ethernet board combinations support simultaneous use, so change the board combinations according to the purpose.

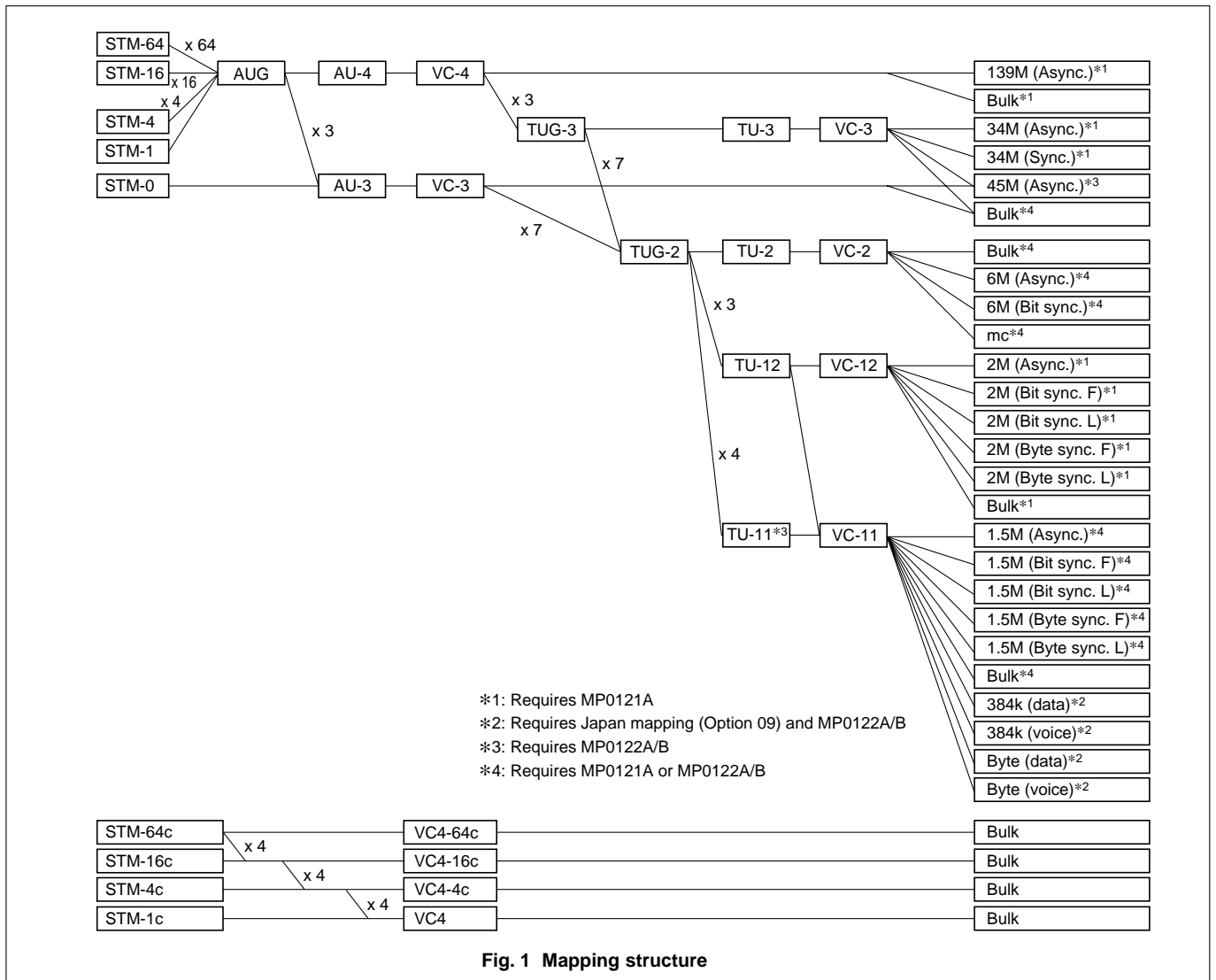

• Jitter/Wander

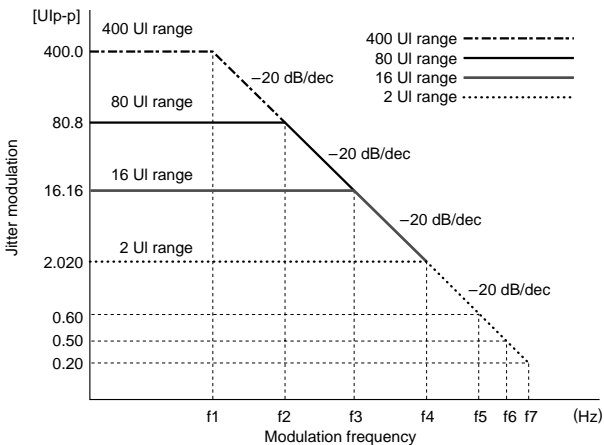
Bit rate	MU150005A: 2.048, 8.448, 34.368, 139.264, 155.52, 622.08 Mbit/s MU150006A: 1.544, 44.736, 51.84, 155.52, 622.08 Mbit/s MU150007A: 1.544, 2.048, 8.448, 34.368, 44.736, 139.264, 51.84, 155.52, 622.08 Mbit/s																																																																																																																																													
Jitter generation	<p>Conform to ITU-T O.171/O.172 Modulation frequency: 0.1 Hz to 6 MHz Amplitude: 0 to 404.0 Ulp-p Resolution: 0.001 Ulp-p (2 UI range), 0.01 Ulp-p (16 UI range), 0.1 Ulp-p (80 UI range), 0.2 Ulp-p (400 UI range)</p>  <table border="1" data-bbox="375 946 901 1244"> <thead> <tr> <th>Bit rate (Mbit/s)</th> <th>f1 (Hz)</th> <th>f2 (Hz)</th> <th>f3 (kHz)</th> <th>f4 (kHz)</th> <th>f5 (kHz)</th> <th>f6 (kHz)</th> <th>f7 (kHz)</th> </tr> </thead> <tbody> <tr> <td>1.544</td> <td>130</td> <td>630</td> <td>3.2</td> <td>25</td> <td>—</td> <td>100</td> <td>—</td> </tr> <tr> <td>2.048</td> <td>300</td> <td>1.5k</td> <td>7.5</td> <td>60</td> <td>—</td> <td>240</td> <td>—</td> </tr> <tr> <td>8.448</td> <td>1.1k</td> <td>5.5k</td> <td>28</td> <td>220</td> <td>—</td> <td>880</td> <td>—</td> </tr> <tr> <td>34.368</td> <td>2.5k</td> <td>13k</td> <td>63</td> <td>500</td> <td>—</td> <td>—</td> <td>5000</td> </tr> <tr> <td>44.736</td> <td>2.5k</td> <td>13k</td> <td>63</td> <td>500</td> <td>—</td> <td>—</td> <td>5000</td> </tr> <tr> <td>139.264</td> <td>9k</td> <td>45k</td> <td>230</td> <td>1800</td> <td>6000</td> <td>—</td> <td>—</td> </tr> <tr> <td>51.84</td> <td>2.5k</td> <td>13k</td> <td>63</td> <td>500</td> <td>—</td> <td>—</td> <td>5000</td> </tr> <tr> <td>155.52</td> <td>7.5k</td> <td>38k</td> <td>190</td> <td>1500</td> <td>—</td> <td>6000</td> <td>—</td> </tr> <tr> <td>622.08</td> <td>3k</td> <td>15k</td> <td>75</td> <td>600</td> <td>—</td> <td>—</td> <td>6000</td> </tr> </tbody> </table> <p>Accuracy 2 UI range: ($\pm Q\%$ of setting) ± 0.02 Ulp-p, 16 UI range: ($\pm Q\%$ of setting) ± 0.2 Ulp-p, 80 UI range: ($\pm Q\%$ of setting) ± 1.2 Ulp-p, 400 UI range: ($\pm Q\%$ of setting) ± 6 Ulp-p</p> <table border="1" data-bbox="375 1330 790 1968"> <thead> <tr> <th>Bit rate (Mbit/s)</th> <th>Error Q</th> <th>Frequency range</th> </tr> </thead> <tbody> <tr> <td rowspan="2">1.544</td> <td>$\pm 12\%$</td> <td>0.1 to 2 Hz</td> </tr> <tr> <td>$\pm 8\%$</td> <td>2 Hz to 100 kHz</td> </tr> <tr> <td rowspan="2">2.048</td> <td>$\pm 12\%$</td> <td>0.1 to 10 Hz</td> </tr> <tr> <td>$\pm 8\%$</td> <td>10 Hz to 240 kHz</td> </tr> <tr> <td rowspan="2">8.448</td> <td>$\pm 12\%$</td> <td>0.1 to 20 Hz</td> </tr> <tr> <td>$\pm 8\%$</td> <td>20 Hz to 880 kHz</td> </tr> <tr> <td rowspan="3">34.368</td> <td>$\pm 12\%$</td> <td>0.1 to 100 Hz</td> </tr> <tr> <td>$\pm 8\%$</td> <td>0.1 to 500 kHz</td> </tr> <tr> <td>$\pm 12\%$</td> <td>500 kHz to 5 MHz</td> </tr> <tr> <td rowspan="2">44.736</td> <td>$\pm 12\%$</td> <td>0.1 to 2 Hz</td> </tr> <tr> <td>$\pm 8\%$</td> <td>2 Hz to 5 MHz</td> </tr> <tr> <td rowspan="4">139.264</td> <td>$\pm 12\%$</td> <td>0.1 to 100 Hz</td> </tr> <tr> <td>$\pm 8\%$</td> <td>0.1 to 500 kHz</td> </tr> <tr> <td>$\pm 12\%$</td> <td>0.5 to 2 MHz</td> </tr> <tr> <td>$\pm 15\%$</td> <td>2 to 6 MHz</td> </tr> <tr> <td rowspan="2">51.84</td> <td>$\pm 12\%$</td> <td>0.1 to 300 Hz</td> </tr> <tr> <td>$\pm 8\%$</td> <td>300 Hz to 5 MHz</td> </tr> <tr> <td rowspan="2">155.52</td> <td>$\pm 12\%$</td> <td>0.1 to 500 Hz</td> </tr> <tr> <td>$\pm 8\%$</td> <td>0.5 to 500 kHz</td> </tr> <tr> <td rowspan="4">622.08</td> <td>$\pm 12\%$</td> <td>0.5 to 6 MHz</td> </tr> <tr> <td>$\pm 12\%$</td> <td>0.1 Hz to 1 kHz</td> </tr> <tr> <td>$\pm 8\%$</td> <td>1 to 500 kHz</td> </tr> <tr> <td>$\pm 12\%$</td> <td>0.5 to 2 MHz</td> </tr> <tr> <td></td> <td>$\pm 15\%$</td> <td>2 to 6 MHz</td> </tr> </tbody> </table>	Bit rate (Mbit/s)	f1 (Hz)	f2 (Hz)	f3 (kHz)	f4 (kHz)	f5 (kHz)	f6 (kHz)	f7 (kHz)	1.544	130	630	3.2	25	—	100	—	2.048	300	1.5k	7.5	60	—	240	—	8.448	1.1k	5.5k	28	220	—	880	—	34.368	2.5k	13k	63	500	—	—	5000	44.736	2.5k	13k	63	500	—	—	5000	139.264	9k	45k	230	1800	6000	—	—	51.84	2.5k	13k	63	500	—	—	5000	155.52	7.5k	38k	190	1500	—	6000	—	622.08	3k	15k	75	600	—	—	6000	Bit rate (Mbit/s)	Error Q	Frequency range	1.544	$\pm 12\%$	0.1 to 2 Hz	$\pm 8\%$	2 Hz to 100 kHz	2.048	$\pm 12\%$	0.1 to 10 Hz	$\pm 8\%$	10 Hz to 240 kHz	8.448	$\pm 12\%$	0.1 to 20 Hz	$\pm 8\%$	20 Hz to 880 kHz	34.368	$\pm 12\%$	0.1 to 100 Hz	$\pm 8\%$	0.1 to 500 kHz	$\pm 12\%$	500 kHz to 5 MHz	44.736	$\pm 12\%$	0.1 to 2 Hz	$\pm 8\%$	2 Hz to 5 MHz	139.264	$\pm 12\%$	0.1 to 100 Hz	$\pm 8\%$	0.1 to 500 kHz	$\pm 12\%$	0.5 to 2 MHz	$\pm 15\%$	2 to 6 MHz	51.84	$\pm 12\%$	0.1 to 300 Hz	$\pm 8\%$	300 Hz to 5 MHz	155.52	$\pm 12\%$	0.1 to 500 Hz	$\pm 8\%$	0.5 to 500 kHz	622.08	$\pm 12\%$	0.5 to 6 MHz	$\pm 12\%$	0.1 Hz to 1 kHz	$\pm 8\%$	1 to 500 kHz	$\pm 12\%$	0.5 to 2 MHz		$\pm 15\%$	2 to 6 MHz
Bit rate (Mbit/s)	f1 (Hz)	f2 (Hz)	f3 (kHz)	f4 (kHz)	f5 (kHz)	f6 (kHz)	f7 (kHz)																																																																																																																																							
1.544	130	630	3.2	25	—	100	—																																																																																																																																							
2.048	300	1.5k	7.5	60	—	240	—																																																																																																																																							
8.448	1.1k	5.5k	28	220	—	880	—																																																																																																																																							
34.368	2.5k	13k	63	500	—	—	5000																																																																																																																																							
44.736	2.5k	13k	63	500	—	—	5000																																																																																																																																							
139.264	9k	45k	230	1800	6000	—	—																																																																																																																																							
51.84	2.5k	13k	63	500	—	—	5000																																																																																																																																							
155.52	7.5k	38k	190	1500	—	6000	—																																																																																																																																							
622.08	3k	15k	75	600	—	—	6000																																																																																																																																							
Bit rate (Mbit/s)	Error Q	Frequency range																																																																																																																																												
1.544	$\pm 12\%$	0.1 to 2 Hz																																																																																																																																												
	$\pm 8\%$	2 Hz to 100 kHz																																																																																																																																												
2.048	$\pm 12\%$	0.1 to 10 Hz																																																																																																																																												
	$\pm 8\%$	10 Hz to 240 kHz																																																																																																																																												
8.448	$\pm 12\%$	0.1 to 20 Hz																																																																																																																																												
	$\pm 8\%$	20 Hz to 880 kHz																																																																																																																																												
34.368	$\pm 12\%$	0.1 to 100 Hz																																																																																																																																												
	$\pm 8\%$	0.1 to 500 kHz																																																																																																																																												
	$\pm 12\%$	500 kHz to 5 MHz																																																																																																																																												
44.736	$\pm 12\%$	0.1 to 2 Hz																																																																																																																																												
	$\pm 8\%$	2 Hz to 5 MHz																																																																																																																																												
139.264	$\pm 12\%$	0.1 to 100 Hz																																																																																																																																												
	$\pm 8\%$	0.1 to 500 kHz																																																																																																																																												
	$\pm 12\%$	0.5 to 2 MHz																																																																																																																																												
	$\pm 15\%$	2 to 6 MHz																																																																																																																																												
51.84	$\pm 12\%$	0.1 to 300 Hz																																																																																																																																												
	$\pm 8\%$	300 Hz to 5 MHz																																																																																																																																												
155.52	$\pm 12\%$	0.1 to 500 Hz																																																																																																																																												
	$\pm 8\%$	0.5 to 500 kHz																																																																																																																																												
622.08	$\pm 12\%$	0.5 to 6 MHz																																																																																																																																												
	$\pm 12\%$	0.1 Hz to 1 kHz																																																																																																																																												
	$\pm 8\%$	1 to 500 kHz																																																																																																																																												
	$\pm 12\%$	0.5 to 2 MHz																																																																																																																																												
	$\pm 15\%$	2 to 6 MHz																																																																																																																																												

Frequency offset Range: ± 999.9 ppm/0.1 ppm steps (jitter off), ± 100 ppm/0.1 ppm steps (jitter on/off)
 Accuracy: ± 0.1 ppm after power-on, calibrates after 60 min warm-up, $23^{\circ} \pm 5^{\circ}C$

Auxiliary interface External modulation input, External 5/10 MHz reference input, Jitter clock/Jitter reference output, Wander reference output

Conform to ITU-T O.171/O.172
 Modulation frequency: 0.1 Hz to 5 MHz
 Amplitude: 0.0 to 400 UI (800 UI: at 622M)
 Resolution:
 0.001 Ulp-p/0.001 Ulrms (2 UI range), 0.01 Ulp-p/0.01 Ulrms (8 UI/20 UI range), 0.2 Ulp-p (400 UI range), 0.5 Ulp-p (800 UI range)

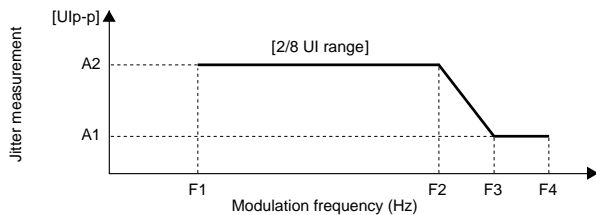

Bit rate (Mbit/s)	A1 (Ulp-p)		A2 (Ulp-p)		F1* (Hz)		F2 (Hz)		F3 (Hz)	F4 (Hz)
	—	Full	Wide	Full	Wide	Full	Wide	—	—	
1.544	0.5	8	2	0.1	10	1.25k	5k	20k	40k	
2.048	0.5	8	2	0.1	10	3.75k	15k	60k	100k	
8.448	0.5	—	2	—	10	—	50k	200k	400k	
34.368	0.5	8	2	0.1	10	18.75k	75k	300k	800k	
44.736	0.5	8	2	0.1	10	25k	100k	400k	400k	
139.264	0.5	8	2	0.1	10	50k	200k	800k	3.5M	
51.84	0.5	8	2	1	10	25k	100k	400k	400k	
155.52	0.4	8	2	1	10	25k	100k	500k	1.3M	
622.08	0.3	8	2	1	10	75k	300k	2M	5M	

*F1 = 100 Hz at RMS

Jitter measurement

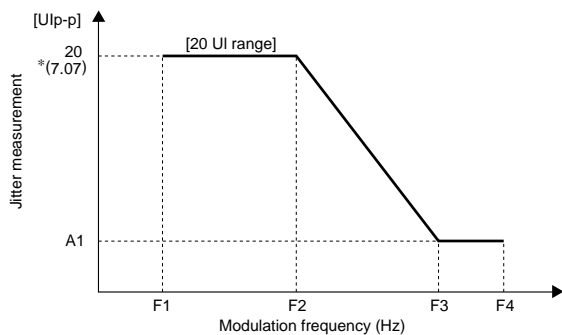

Bit rate (Mbit/s)	A1 (Ulp-p)	F1* (Hz)		F2 (Hz)	F3 (Hz)	F4 (Hz)
	—	Full	Wide	—	—	—
1.544	0.67	0.1	1	600	15k	15k
2.048	1.67	0.1	1	1.5k	18k	18k
8.448	1.43	0.1	1	5k	70k	70k
34.368	0.5	0.1	1	8k	300k	300k
44.736	0.5	0.1	1	10k	400k	400k
139.264	0.5	0.1	1	20k	800k	1.2M
51.84	0.5	1	1	10k	400k	400k
155.52	0.4	1	1	10k	500k	1.3M
622.08	0.3	1	1	30k	2M	5M

*F1 = 100 Hz at RMS

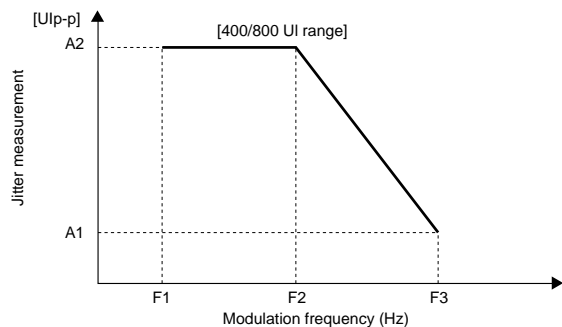

Bit rate (Mbit/s)	A1 (Ulp-p)	A2 (Ulp-p)	F1** (Hz)	F2 (Hz)	F3 (Hz)
1.544	20	400	0.1	10	200
2.048	20	400	0.1	10	200
8.448	20	400	0.1	10	200
34.368	20	400	0.1	10	200
44.736	20	400	0.1	10	200
139.264	20	400	0.1	10	200
51.84	20	400	0.1	10	200
155.52	4	400	0.1	10	1k
622.08	4	800	0.1	10	2k

** : Full band only

Filter:
Conform to O.171/O.172, LP, HP0 + LP, HP1 + LP, HP2 + LP, HP + LP, user

Bit rate (Mbit/s)	HP0 (Hz)	HP1 (Hz)	HP2 (Hz)	HP2' (Hz)	HP (Hz)	LP (Hz)
1.544	10	10	8k	—	12k	40k
2.048	10	20	18k	700	12k	100k
8.448	10	20	3k	80k	12k	400k
34.368	10	100	10k	—	12k	800k
44.736	10	10	30k	—	12k	400k
139.264	10	200	10k	—	12k	3.5M
51.84	10	100	20k	—	12k	400k
155.52	10	500	65k	—	12k	1.3M
622.08	10	1k	250k	—	12k	5M

Accuracy (Ulp-p, UI+p, UI-p)

2 UI range: $\pm R\%$ of reading $\pm W$ Ulp-p, 20 UI range: $\pm R\%$ of reading $\pm W$ Ulp-p, 400 UI range: $\pm R\%$ of reading $\pm W$ Ulp-p, 800 UI range: $\pm R\%$ of reading $\pm W$ Ulp-p

Fixed error [W]

Ulp-p

Bit rate (Mbit/s)	Pseudo-random signal								Bit length
	HP1 + LP				HP2 + LP				
	2 UI	8 UI	20 UI	400/800 UI	2 UI	8 UI	20 UI		
1.544	0.040	0.08	0.22	3.5	0.025	0.05	0.15	$2^{20} - 1$	
2.048	0.040	0.08	0.22	3.5	0.025	0.05	0.15	$2^{15} - 1$	
8.448	0.040	—	0.22	3.5	0.025	—	0.15	$2^{15} - 1$	
34.368	0.040	0.08	0.22	3.5	0.025	0.05	0.15	$2^{23} - 1$	
44.736	0.040	0.08	0.22	3.5	0.025	0.05	0.15	$2^{15} - 1$	
139.264	0.040	0.08	0.30	5.0	0.025	0.05	0.15	$2^{23} - 1$	

Bit rate (Mbit/s)	Clock signal							
	HP1 + LP				HP2 + LP			
	2 UI	8 UI	20 UI	400/800 UI	2 UI	8 UI	20 UI	
1.544	0.015	0.03	0.10	1.6	0.010	0.02	0.08	
2.048	0.015	0.03	0.10	1.6	0.010	0.02	0.08	
8.448	0.015	—	0.10	1.6	0.010	—	0.08	
34.368	0.030	0.06	0.18	2.8	0.020	0.04	0.15	
44.736	0.030	0.06	0.18	2.8	0.020	0.04	0.15	
139.264	0.030	0.06	0.22	3.8	0.020	0.04	0.20	

Bit rate (Mbit/s)	SONET/SDH signal								Container
	HP1 + LP				HP2 + LP				
	2 UI	8 UI	20 UI	400/800 UI	2 UI	8 UI	20 UI		
51.84e	0.070	0.14	0.30	5.0	0.050	0.10	0.20	VC3	
51.84o	0.070	0.14	0.30	5.0	0.050	0.10	0.20	VC3	
155.52e	0.070	0.14	0.30	5.0	0.025	0.05	0.20	VC4	
155.52o	0.070	0.14	0.30	5.0	0.050	0.10	0.20	VC4	
622.08	0.100	0.20	0.30	10.0	0.050	0.10	0.20	VC4-4c	

At PRBS $2^{23} - 1$

Bit rate (Mbit/s)	Clock signal							
	HP1 + LP				HP2 + LP			
	2 UI	8 UI	20 UI	400/800 UI	2 UI	8 UI	20 UI	
51.84e	0.050	0.10	0.22	3.8	0.030	0.06	0.20	
155.52e	0.050	0.10	0.22	3.8	0.030	0.06	0.20	
622.08	0.050	0.10	0.22	5.0	0.030	0.06	0.20	

Jitter measurement

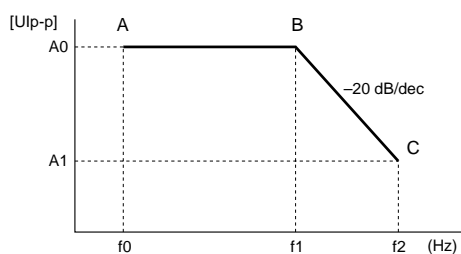
Jitter measurement	Frequency error [R]	<table border="1"> <thead> <tr> <th>Frequency error</th> <th>Frequency range</th> </tr> </thead> <tbody> <tr> <td>±10%</td> <td>0.1 to 20 Hz</td> </tr> <tr> <td>±7%</td> <td>20 Hz to 300 kHz</td> </tr> <tr> <td>±8%</td> <td>300 kHz to 1 MHz</td> </tr> <tr> <td>±10%</td> <td>1 to 3 MHz</td> </tr> <tr> <td>±15%</td> <td>3 to 5 MHz</td> </tr> </tbody> </table>	Frequency error	Frequency range	±10%	0.1 to 20 Hz	±7%	20 Hz to 300 kHz	±8%	300 kHz to 1 MHz	±10%	1 to 3 MHz	±15%	3 to 5 MHz																																															
	Frequency error	Frequency range																																																											
	±10%	0.1 to 20 Hz																																																											
	±7%	20 Hz to 300 kHz																																																											
	±8%	300 kHz to 1 MHz																																																											
	±10%	1 to 3 MHz																																																											
	±15%	3 to 5 MHz																																																											
	Ulrms	2 UI range: ±R% ±Y Ulrms, 20 UI range: ±R% ±Y Ulrms																																																											
	Fixed error [Y]	Ulrms																																																											
		<table border="1"> <thead> <tr> <th rowspan="3">Bit rate (Mbit/s)</th> <th colspan="4">Pseudo-random signal</th> </tr> <tr> <th colspan="3">HP + LP</th> <th rowspan="2">Bit length</th> </tr> <tr> <th>2 UI</th> <th>8 UI</th> <th>20 UI</th> </tr> </thead> <tbody> <tr> <td>1.544</td> <td>0.006</td> <td>0.02</td> <td>0.04</td> <td>2²⁰ - 1</td> </tr> <tr> <td>2.048</td> <td>0.006</td> <td>0.02</td> <td>0.04</td> <td>2¹⁵ - 1</td> </tr> <tr> <td>8.448</td> <td>0.006</td> <td>—</td> <td>0.04</td> <td>2¹⁵ - 1</td> </tr> <tr> <td>34.368</td> <td>0.008</td> <td>0.02</td> <td>0.05</td> <td>2²³ - 1</td> </tr> <tr> <td>44.736</td> <td>0.008</td> <td>0.02</td> <td>0.05</td> <td>2¹⁵ - 1</td> </tr> <tr> <td>139.264</td> <td>0.008</td> <td>0.02</td> <td>0.05</td> <td>2²³ - 1</td> </tr> </tbody> </table>	Bit rate (Mbit/s)	Pseudo-random signal				HP + LP			Bit length	2 UI	8 UI	20 UI	1.544	0.006	0.02	0.04	2 ²⁰ - 1	2.048	0.006	0.02	0.04	2 ¹⁵ - 1	8.448	0.006	—	0.04	2 ¹⁵ - 1	34.368	0.008	0.02	0.05	2 ²³ - 1	44.736	0.008	0.02	0.05	2 ¹⁵ - 1	139.264	0.008	0.02	0.05	2 ²³ - 1																	
Bit rate (Mbit/s)	Pseudo-random signal																																																												
	HP + LP			Bit length																																																									
	2 UI	8 UI	20 UI																																																										
1.544	0.006	0.02	0.04	2 ²⁰ - 1																																																									
2.048	0.006	0.02	0.04	2 ¹⁵ - 1																																																									
8.448	0.006	—	0.04	2 ¹⁵ - 1																																																									
34.368	0.008	0.02	0.05	2 ²³ - 1																																																									
44.736	0.008	0.02	0.05	2 ¹⁵ - 1																																																									
139.264	0.008	0.02	0.05	2 ²³ - 1																																																									
	<table border="1"> <thead> <tr> <th rowspan="3">Bit rate (Mbit/s)</th> <th colspan="3">Clock signal</th> </tr> <tr> <th colspan="3">HP + LP</th> </tr> <tr> <th>2 UI</th> <th>8 UI</th> <th>20 UI</th> </tr> </thead> <tbody> <tr> <td>1.544</td> <td>0.004</td> <td>0.02</td> <td>0.03</td> </tr> <tr> <td>2.048</td> <td>0.004</td> <td>0.02</td> <td>0.03</td> </tr> <tr> <td>8.448</td> <td>0.004</td> <td>—</td> <td>0.03</td> </tr> <tr> <td>34.368</td> <td>0.006</td> <td>0.02</td> <td>0.04</td> </tr> <tr> <td>44.736</td> <td>0.006</td> <td>0.02</td> <td>0.04</td> </tr> <tr> <td>139.264</td> <td>0.006</td> <td>0.02</td> <td>0.04</td> </tr> </tbody> </table>	Bit rate (Mbit/s)	Clock signal			HP + LP			2 UI	8 UI	20 UI	1.544	0.004	0.02	0.03	2.048	0.004	0.02	0.03	8.448	0.004	—	0.03	34.368	0.006	0.02	0.04	44.736	0.006	0.02	0.04	139.264	0.006	0.02	0.04																										
Bit rate (Mbit/s)	Clock signal																																																												
	HP + LP																																																												
	2 UI	8 UI	20 UI																																																										
1.544	0.004	0.02	0.03																																																										
2.048	0.004	0.02	0.03																																																										
8.448	0.004	—	0.03																																																										
34.368	0.006	0.02	0.04																																																										
44.736	0.006	0.02	0.04																																																										
139.264	0.006	0.02	0.04																																																										
	<table border="1"> <thead> <tr> <th rowspan="3">Bit rate (Mbit/s)</th> <th colspan="4">SONET/SDH signal</th> </tr> <tr> <th colspan="3">HP + LP</th> <th rowspan="2">Container</th> </tr> <tr> <th>2 UI</th> <th>8 UI</th> <th>20 UI</th> </tr> </thead> <tbody> <tr> <td>51.84e</td> <td>0.010</td> <td>0.02</td> <td>0.06</td> <td>VC3</td> </tr> <tr> <td>51.84o</td> <td>0.010</td> <td>0.02</td> <td>0.06</td> <td>VC3</td> </tr> <tr> <td>155.52e</td> <td>0.010</td> <td>0.02</td> <td>0.06</td> <td>VC4</td> </tr> <tr> <td>155.52o</td> <td>0.010</td> <td>0.02</td> <td>0.06</td> <td>VC4</td> </tr> <tr> <td>622.08</td> <td>0.012</td> <td>0.03</td> <td>0.08</td> <td>VC4-4c</td> </tr> </tbody> </table> <p style="text-align: center;">At PRBS 2²³ - 1</p>	Bit rate (Mbit/s)	SONET/SDH signal				HP + LP			Container	2 UI	8 UI	20 UI	51.84e	0.010	0.02	0.06	VC3	51.84o	0.010	0.02	0.06	VC3	155.52e	0.010	0.02	0.06	VC4	155.52o	0.010	0.02	0.06	VC4	622.08	0.012	0.03	0.08	VC4-4c																							
Bit rate (Mbit/s)	SONET/SDH signal																																																												
	HP + LP			Container																																																									
	2 UI	8 UI	20 UI																																																										
51.84e	0.010	0.02	0.06	VC3																																																									
51.84o	0.010	0.02	0.06	VC3																																																									
155.52e	0.010	0.02	0.06	VC4																																																									
155.52o	0.010	0.02	0.06	VC4																																																									
622.08	0.012	0.03	0.08	VC4-4c																																																									
	<table border="1"> <thead> <tr> <th rowspan="3">Bit rate (Mbit/s)</th> <th colspan="3">Clock signal</th> </tr> <tr> <th colspan="3">HP + LP</th> </tr> <tr> <th>2 UI</th> <th>8 UI</th> <th>20 UI</th> </tr> </thead> <tbody> <tr> <td>51.84e</td> <td>0.008</td> <td>0.02</td> <td>0.05</td> </tr> <tr> <td>155.52e</td> <td>0.008</td> <td>0.02</td> <td>0.05</td> </tr> <tr> <td>622.08</td> <td>0.010</td> <td>0.02</td> <td>0.06</td> </tr> </tbody> </table>	Bit rate (Mbit/s)	Clock signal			HP + LP			2 UI	8 UI	20 UI	51.84e	0.008	0.02	0.05	155.52e	0.008	0.02	0.05	622.08	0.010	0.02	0.06																																						
Bit rate (Mbit/s)	Clock signal																																																												
	HP + LP																																																												
	2 UI	8 UI	20 UI																																																										
51.84e	0.008	0.02	0.05																																																										
155.52e	0.008	0.02	0.05																																																										
622.08	0.010	0.02	0.06																																																										
	Frequency error [R]	<table border="1"> <thead> <tr> <th>Frequency error</th> <th>Frequency range</th> </tr> </thead> <tbody> <tr> <td>±10%</td> <td>0.1 to 20 Hz</td> </tr> <tr> <td>±7%</td> <td>20 Hz to 300 kHz</td> </tr> <tr> <td>±8%</td> <td>300 kHz to 1 MHz</td> </tr> <tr> <td>±10%</td> <td>1 to 3 MHz</td> </tr> <tr> <td>±15%</td> <td>3 to 5 MHz</td> </tr> </tbody> </table>	Frequency error	Frequency range	±10%	0.1 to 20 Hz	±7%	20 Hz to 300 kHz	±8%	300 kHz to 1 MHz	±10%	1 to 3 MHz	±15%	3 to 5 MHz																																															
Frequency error	Frequency range																																																												
±10%	0.1 to 20 Hz																																																												
±7%	20 Hz to 300 kHz																																																												
±8%	300 kHz to 1 MHz																																																												
±10%	1 to 3 MHz																																																												
±15%	3 to 5 MHz																																																												
Hit measurement	Count, Seconds, % free seconds																																																												
Frequency measurement	Resolution: 0.1 ppm, Display: Hz or ppm (After power-on, calibrates after 60 min warm-up, 23' ±5°C)																																																												
Auxiliary interface	Demodulation output, Clock/Reference input																																																												
Jitter auto measurement	<p>Jitter tolerance measurement: Evaluates jitter tolerance point automatically</p> <p>Jitter sweep measurement: Conforms to high-speed jitter tolerance evaluation for mass production, etc.</p> <p>Jitter transfer measurement: High dynamic range measurement by selective level method (variable)</p> <p>Jitter frequency measurement: Measures the mapping jitter automatically</p> <p>Frequency sweep measurement: Measures the jitter tolerance automatically while changing the offset</p>																																																												
Line wander generation	<p>Modulation frequency: 10 μHz to 10 Hz (sine wave)</p> <p>Amplitude: 0 to 400,000 UI (10 Ulp-p steps)</p>  <table border="1"> <thead> <tr> <th>Bit rate (Mbit/s)</th> <th>f0 (μHz)</th> <th>f1 (mHz)</th> <th>f2 (Hz)</th> <th>A0 (Ulp-p)</th> <th>A1 (Ulp-p)</th> </tr> </thead> <tbody> <tr> <td>1.544</td> <td>10</td> <td>20</td> <td>10</td> <td>400,000</td> <td>800</td> </tr> <tr> <td>2.048</td> <td>10</td> <td>20</td> <td>10</td> <td>400,000</td> <td>800</td> </tr> <tr> <td>8.448</td> <td>10</td> <td>200</td> <td>10</td> <td>400,000</td> <td>8,000</td> </tr> <tr> <td>34.368</td> <td>10</td> <td>400</td> <td>10</td> <td>400,000</td> <td>16,000</td> </tr> <tr> <td>44.736</td> <td>10</td> <td>400</td> <td>10</td> <td>400,000</td> <td>16,000</td> </tr> <tr> <td>139.264</td> <td>10</td> <td>2,000</td> <td>10</td> <td>400,000</td> <td>80,000</td> </tr> <tr> <td>51.84</td> <td>10</td> <td>400</td> <td>10</td> <td>400,000</td> <td>16,000</td> </tr> <tr> <td>155.52</td> <td>10</td> <td>2,000</td> <td>10</td> <td>400,000</td> <td>80,000</td> </tr> <tr> <td>622.08</td> <td>10</td> <td>400</td> <td>10</td> <td>400,000</td> <td>16,000</td> </tr> </tbody> </table>	Bit rate (Mbit/s)	f0 (μHz)	f1 (mHz)	f2 (Hz)	A0 (Ulp-p)	A1 (Ulp-p)	1.544	10	20	10	400,000	800	2.048	10	20	10	400,000	800	8.448	10	200	10	400,000	8,000	34.368	10	400	10	400,000	16,000	44.736	10	400	10	400,000	16,000	139.264	10	2,000	10	400,000	80,000	51.84	10	400	10	400,000	16,000	155.52	10	2,000	10	400,000	80,000	622.08	10	400	10	400,000	16,000
Bit rate (Mbit/s)	f0 (μHz)	f1 (mHz)	f2 (Hz)	A0 (Ulp-p)	A1 (Ulp-p)																																																								
1.544	10	20	10	400,000	800																																																								
2.048	10	20	10	400,000	800																																																								
8.448	10	200	10	400,000	8,000																																																								
34.368	10	400	10	400,000	16,000																																																								
44.736	10	400	10	400,000	16,000																																																								
139.264	10	2,000	10	400,000	80,000																																																								
51.84	10	400	10	400,000	16,000																																																								
155.52	10	2,000	10	400,000	80,000																																																								
622.08	10	400	10	400,000	16,000																																																								

Line wander generation	Accuracy: $\pm Q\%$ of setting ± 100 Ulp-p								
	<table border="1"> <thead> <tr> <th>Error Q</th> <th>Frequency range</th> </tr> </thead> <tbody> <tr> <td>$\pm 8\%$</td> <td>10 μHz to 0.125 Hz</td> </tr> <tr> <td>$\pm 12\%$</td> <td>0.125 Hz to 1 Hz</td> </tr> <tr> <td>$\pm 15\%$</td> <td>1 to 10 Hz</td> </tr> </tbody> </table>	Error Q	Frequency range	$\pm 8\%$	10 μ Hz to 0.125 Hz	$\pm 12\%$	0.125 Hz to 1 Hz	$\pm 15\%$	1 to 10 Hz
	Error Q	Frequency range							
	$\pm 8\%$	10 μ Hz to 0.125 Hz							
$\pm 12\%$	0.125 Hz to 1 Hz								
$\pm 15\%$	1 to 10 Hz								
Wander auto measurement	Automatically evaluates the wander of the sine wave by the wander sweep measurement								
Reference wander generation	<p>Off: Able to set non-modulated status</p> <p>TDEV mask: The 37 types of TDEV masks that are regulated by ITU-T, ETSI, ANSI, and Bellcore standards are available as default. It is possible to add the wander modulation on the user specified TDEV mask.</p> <p>Transient: It is possible to change the A ($1 - e^{-63.7t}$) phase by the timing of the start.</p> <p>Signal off: It is possible to disconnect the standard signal.</p>								
Wander measurement	<p>Conform to ITU-T O.172</p> <p>Reference input: 2.048M (HDB3, Clock), 1.544M (AMI/B8ZS, Clock), 64k + 8 kHz, 5 MHz, 10 MHz</p> <p>Sampling frequency: 40 Hz, 1 Hz, 0.1 Hz, 5 mHz (select by MX150001B)</p> <p>Measurement range P-P: 0.0 to 2E10 ns, +P/-P: 0.0 to 1E10 ns, TIE: 0.0 to $\pm 1E10$ ns</p> <p>Accuracy: Conform to ITU-T O.172</p> <p>Measurement time: 10 to 1×10^8 s (max. 120,000 s; MP1577A only)</p> <p>Wander application (requires MX150001B Wander Application Software) TIE: Max. 1×10^8 s, MTIE: Max. 1×10^8 s, TDEV: Max. 1×10^6 s</p> <p>Frequency offset: Measurement conforms to ANSI T1.105.09</p> <p>Frequency drift rate: Measurement conforms to ANSI T1.105.09</p> <p>MRTIE: The evaluation separated from the wander by a frequency offset</p> <p>Wander tolerance (TDEV) measurement: Evaluation by the various TDEV mask generations</p> <p>Wander transfer (TDEV) measurement: Calibration method by simulation, outputting results by the one measurement</p>								



• **156M/622M optical I/O**

Bit rate	155.52, 622.08 Mbit/s (NRZ)
Transmit	Wavelength: 1310/1550 nm Output level 1.31 μ m: -11.5 dBm \pm 3.5 dB, 1.55 μ m: -5 dBm \pm 2 dB Optical safety: IEC825-1 Class 1, 21CFR1040.10 Class I Connector: FC-PC (SM-F)
Receive	Sensitivity 156M: -33 to -8 dBm (test pattern: PRBS 2 ²³ -1, BER 10 ⁻¹⁰ , +10° to +40°C) 622M: -28 to -8 dBm (test pattern: PRBS 2 ²³ -1, BER 10 ⁻¹⁰ , +10° to +40°C) Connector: FC-PC (SM-F) Power measurement Measurement range: -30 to 0 dBm (peak power) Accuracy: \leq \pm 1 dB (-20 dBm) Linearity: \leq \pm 1 dB (-30 to 0 dBm)

• **2.5G/10G optical output (Option 20)**

Bit rate	9953.28, 2488.32 Mbit/s
Transmit	Wavelength 10G: 1550 nm band 2.5G: 1310/1550 nm band Output level: -4 dBm \pm 3 dB Optical safety: IEC825-1 Class 3A, 21CFR1040.10 Class IIIb Connector: FC-PC (SMF)
Electrical input	Data input H: 0 to -0.2 V, L: -0.85 to -1.4 V Clock input H: 0 to -0.2 V, L: -0.85 to -1.3 V Connector: SMA 50 Ω

• **2.5G/10G optical input**

Bit rate	9953.28, 2488.32 Mbit/s
Receive	Wavelength: Option 20 (10G: 1550 nm, 2.5G: 1310/1550 nm) Option 21 (10G: 1310 nm, 2.5G: 1310 nm) Sensitivity 10G: -13 to -3 dBm (BER 10 ⁻¹² , NRZ, mark ratio: 1/2, PRBS: 2 ³¹ -1) 2.5G: -29 to -10 dBm (BER 10 ⁻¹¹ , NRZ, mark ratio: 1/2, PRBS: 2 ²³ -1) Connector: FC-PC (SMF) Power measurement Range: -16 to 0 dBm (10G, average power), -30 to -10 dBm (2.5G, average power) Accuracy: \leq \pm 2 dB (10G, -10 dBm), \leq \pm 2 dB (2.5G, -20 dBm) Linearity: \leq \pm 2 dB (10G, -16 to 0 dBm), \leq \pm 2 dB (2.5G, -30 to -10 dBm)
Electrical output	Data output: 0.65 to 1.4 Vp-p Clock output: 0.65 to 1.3 Vp-p Connector: SMA 50 Ω

• **2.5G/10G optical output (Option 21)**

Bit rate	9953.28 Mbit/s, 2488.32 Mbit/s
Transmit	Wavelength: 1290 to 1330 nm Output level: +3 dBm \pm 2 dB Optical Safety: IEC825-1 (Class 3A), 21CFR1040.10 (Class IIIb) Connector: FC-PC (SM-F)
Electrical input	Data input H: 0 to -0.2 V, L: -0.85 to -1.4 V Clock input H: 0 to -0.2 V, L: -0.85 to -1.3 V Connector: SMA (50 Ω)

• **2.5G/10G electrical I/O**

Bit rate	9953.28, 2488.32 Mbit/s (NRZ)
Transmit	Level Data H: 0 to -0.2 V, Data L: -0.85 to -1.4 V Clock H: 0 to -0.2 V, Clock L: -0.85 to -1.3 V Connector (Data, Clock): SMA (50 Ω)
Receive	Level Data: 0.65 to 1.4 Vp-p, Clock: 0.65 to 1.3 Vp-p Connector (Data, Clock): SMA (50 Ω)
Auxiliary interface	External clock input, Internal clock output, Receive clock output, 156M sync. output

Typical Configuration

MP1577A (with Option 20) + MP0121A



MP1577A (with Option 21) + MP0122B



Note:
The MP0121A or MP0122A/B can be inserted to slot 1.
The modules in slots 2 to 5 are fixed and can not exchanged.

Typical Configuration

MP1577A (with Option 22)



MP1577A (with Option 23)



MP1577A (with Option 24)



Typical Configuration

MP1577A (with Option 25)



MP1577A (with Option 26)



MP1577A (with Option 27)



Ordering Information

Please specify the model/order number and quantity when ordering.

Model/Order No.	Name	Remarks
MP1577A*1.*2	Main frame SONET/SDH/PDH/DSn Analyzer	Requires one of Option from Option 20 to 27
	Standard accessories	
	AC power cord: 1 pc	
Z0169	Printer paper (5 rolls/pack): 1 pack	
F0079	Fuse, 10 A: 2 pcs	
B0329G	Front cover: 1 pc	
Z0486	Side cover: 1 pc	
J0907Q	Remote interlock cord: 1 pc	For 2.5G/10G optical output
J0908	Remote interlock terminator: 1 pc	For 2.5G/10G optical output
E0008A	Optical output control key: 1 pc	For 2.5G/10G optical output
J0747B	Fixed optical attenuator (10 dB): 1 pc	For 2.5G/10G optical input
J0635A	Optical fiber cable (FC · PC-FC · PC) 1 m: 1 pc	
W2002AE	MP1577A operation manual (Vol. 1 Basic operation for SDH): 1 copy	
W2003AE	MP1577A operation manual (Vol. 1 Basic operation for SONET): 1 copy	
W2004AE	MP1577A operation manual (Vol. 2 Remote control): 1 copy	
J1002A	Semi-rigid cable: 1 set	For 2.5G/10G optical output (2 pcs/set)
J1002B	Semi-rigid cable: 1 set	For 2.5G/10G optical input (2 pcs/set)
J1002C	Semi-rigid cable: 1 set	For 2.5G/10G electrical I/O (3 pcs/set)
	Plug-in units	
MP0121A	2/8/34/139/156M Unit	
MP0122A	1.5/45/52M Unit	
MP0122B*1	1.5/45/52/52M (1.31) Unit	
	Options	
MP1577A-01*3	RS-232C	
MP1577A-02*3	GPIO	
MP1577A-03*3	Ethernet	
MP1577A-04*3	VGA output	
MP1577A-06	MUX/DEMUX (2/8/34/139 Mb/s)	For MP0121A
MP1577A-07	MUX/DEMUX (1.5/45 Mb/s)	For MP0122A/B
MP1577A-09	Japan mapping	Requires MP0122A or MP0122B
MP1577A-20*4	10G (1.55 μm)/2.5G (1.31/1.55 μm) Transmission	
MP1577A-21*4	10G (1.31 μm)/2.5G (1.31 μm) Transmission	
MP1577A-22*4	2M - 622M Transmission with Jitter and Wander	
MP1577A-23*4	1.5M - 622M Transmission with Jitter and Wander	
MP1577A-24*4	1.5M/2M - 622M Transmission with Jitter and Wander	
MP1577A-25*4	2M - 622M Transmission	
MP1577A-26*4	1.5M - 622M Transmission	
MP1577A-27*4	1.5M/2M - 622M Transmission	
MP1577A-37	FC connector	Replaceable, with protective caps, 6 sets
MP1577A-38	ST connector	Replaceable, with protective caps, 6 sets
MP1577A-39	DIN connector	Replaceable, with protective caps, 6 sets
MP1577A-40	SC connector	Replaceable, with protective caps, 6 sets
MP1577A-43	HMS-10/A connector	Replaceable, with protective caps, 6 sets
MP1577A-90	Extended three years warranty service	
MP0121A-90	Extended three years warranty service	
MP0122A-90	Extended three years warranty service	
MP0122B-90	Extended three years warranty service	
MP0122B-37	FC connector	Replaceable, with protective caps, 2 sets
MP0122B-38	ST connector	Replaceable, with protective caps, 2 sets
MP0122B-39	DIN connector	Replaceable, with protective caps, 2 sets
MP0122B-40	SC connector	Replaceable, with protective caps, 2 sets
MP0122B-43	HMS-10/A connector	Replaceable, with protective caps, 2 sets
	Application equipment	
J0796A	ST connector	Replaceable, with protective caps, 1 set
J0796B	DIN connector	Replaceable, with protective caps, 1 set
J0796C	SC connector	Replaceable, with protective caps, 1 set
J0796D	HMS-10/A connector	Replaceable, with protective caps, 1 set
J0796E	FC connector	Replaceable, with protective caps, 1 set
J0162A	Balanced cable, 1 m	Siemens 3P/Siemens 3P
J0162B	Balanced cable, 2 m	Siemens 3P/Siemens 3P
J0845A	Balanced cable, 6 ft	BANTAM 3P/ BANTAM 3P
J0775B	Coaxial cable (BNC-P620 · 3C-2WS · BNC-P620), 0.5 m (75 Ω)	

Model/Order No.	Name	Remarks
J0775D	Coaxial cable (BNC-P620 · 3C-2WS · BNC-P620), 2 m (75 Ω)	
J0776D	Coaxial cable (BNC-P-3W · 3D-2W · BNC-P-3W), 2 m (50 Ω)	
J0635A	Optical fiber cable, 1 m	SM, FC-SPC connector both ends
J0635B	Optical fiber cable, 2 m	SM, FC-SPC connector both ends
J0635C	Optical fiber cable, 3 m	SM, FC-SPC connector both ends
J0747A	Fixed optical attenuator (5 dB)	
J0747B	Fixed optical attenuator (10 dB)	
J0747C	Fixed optical attenuator (15 dB)	
J0747D	Fixed optical attenuator (20 dB)	
J0322B	Coaxial cable (11SMA · SUCOFLEX104 · 11SMA), 1 m	
J0008	GPIB cable, 2 m	
B0448	Soft case	
B0336C	Carrying case	
B0454C	Blank panel (for slot 1)	
MA1314A	I-214/3-pole CF adapter	
MP35A	Matching Transformer	75 Ω (unbalance)/120 Ω (balance)
J0698	High impedance pad	Attenuator: 20 dB
J0697	T-pad	BNC-TA619

*1: Specify one of FC, ST, DIN, SC or HMS-10/A. If the connector is not specified, an FC connector will be supplied as standard.

*2: Specify Option 20 or Option 21 when ordering.

*3: The video output, RS-232C, GPIB and Ethernet options cannot all be used simultaneously. Only the video output + RS-232C, video output + GPIB or video output + Ethernet board combinations support simultaneous use, so change the board combinations according to the purpose.

*4: The Option 20, 21, 22, 23, 24, 25, 26 and Option 27 can not be installed simultaneously.



Carrying case



Soft case



Specifications are subject to change without notice.

ANRITSU CORPORATION

5-10-27, Minamiazabu, Minato-ku, Tokyo 106-8570, Japan
Phone: +81-3-3446-1111
Telex: J34372
Fax: +81-3-3442-0235

● U.S.A. ANRITSU COMPANY

North American Region Headquarters
1155 East Collins Blvd., Richardson, TX 75081, U.S.A.
Toll Free: 1-800-ANRITSU (267-4878)
Phone: +1-972-644-1777
Fax: +1-972-671-1877

● Canada ANRITSU ELECTRONICS LTD.

700 Silver Seven Road, Suite 120, Kanata,
ON K2V 1C3, Canada
Phone: +1-613-591-2003
Fax: +1-613-591-1006

● Brasil ANRITSU ELETRÔNICA LTDA.

Praia de Botafogo 440, Sala 2401 CEP 22250-040,
Rio de Janeiro, RJ, Brasil
Phone: +55-21-5276922
Fax: +55-21-537-1456

● U.K.
ANRITSU LTD.
200 Capability Green, Luton, Bedfordshire LU1 3LU, U.K.
Phone: +44-1582-433200
Fax: +44-1582-731303

● Germany
ANRITSU GmbH
Grafenberger Allee 54-56, 40237 Düsseldorf, Germany
Phone: +49-211-96855-0
Fax: +49-211-96855-55

● France
ANRITSU S.A.
9, Avenue du Québec Z.A. de Courtabœuf 91951 Les
Ulis Cedex, France
Phone: +33-1-60-92-15-50
Fax: +33-1-64-46-10-65

● Italy
ANRITSU S.p.A.
Via Elio Vittorini, 129, 00144 Roma EUR, Italy
Phone: +39-06-509-9711
Fax: +39-06-502-24-25

● Sweden
ANRITSU AB
Botvid Center, Fittja Backe 1-3 145 84 Stockholm,
Sweden
Phone: +46-853470700
Fax: +46-853470730

● Spain
ANRITSU ELECTRÓNICA, S.A.
Europa Empresarial Edificio Londres, Planta 1, Oficina
6 C/ Playa de Liencres, 2 28230 Las Rozas. Madrid,
Spain
Phone: +34-91-6404460
Fax: +34-91-6404461

● Singapore
ANRITSU PTE LTD.
10, Hoe Chiang Road #07-01/02, Keppel Towers,
Singapore 089315
Phone: +65-6282-2400
Fax: +65-6282-2533

● Hong Kong
ANRITSU COMPANY LTD.
Suite 719, 7/F., Chinachem Golden Plaza, 77 Mody
Road, Tsimshatsui East, Kowloon, Hong Kong, China
Phone: +852-2301-4980
Fax: +852-2301-3545

● Korea
ANRITSU CORPORATION
14F Hyun Juk Bldg. 832-41, Yeoksam-dong,
Kangnam-ku, Seoul, Korea
Phone: +82-2-553-6603
Fax: +82-2-553-6604-5

● Australia
ANRITSU PTY LTD.
Unit 3/170 Forster Road Mt. Waverley, Victoria, 3149,
Australia
Phone: +61-3-9558-8177
Fax: +61-3-9558-8255

● Taiwan
ANRITSU COMPANY INC.
6F, 96, Sec. 3, Chien Kou North Rd. Taipei, Taiwan
Phone: +886-2-2515-6050
Fax: +886-2-2509-5519