

MAINTENANCE MANUAL
Site Master™ Model S113B/S331B
Antenna, Cable and Spectrum Analyzers

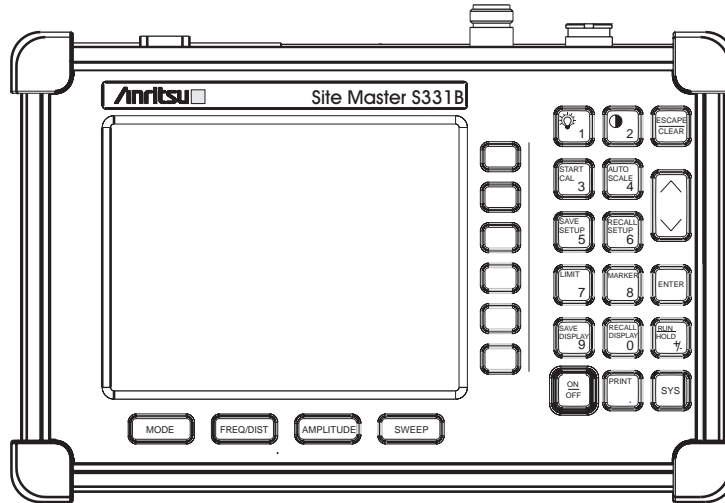

Figure 1. Site Master Model S113B/S331B

1. INTRODUCTION

This manual provides maintenance instructions for the Site Master S113B/S331B Antenna and Cable Analyzer. It describes the product and provides performance verification procedures, parts replacement procedures, and a replaceable parts list.

2. DESCRIPTION

The Site Master (Figure 1) is a hand held SWR/RL (standing wave ratio/return loss), and Distance-To-Fault measurement instrument. It combines a synthesized source, VSWR Bridge, and receiver on a single printed circuit board (PCB). An optional power monitor is also available. A block diagram is shown in Figure 2.

3. PERFORMANCE VERIFICATION

Paragraphs 4 through 9 contain tests that can be used to verify the performance of the Site Master models S113 and S331B having any version of firmware.

3.1. Initial Setup for Testing

1. Press and hold the **ESCAPE/CLEAR** key, then press the **ON/OFF** key to turn on the Site Master. (This sets the instrument to the factory preset state.)
2. Release the **ESCAPE/CLEAR** key and use the Up/Down arrow key to adjust the contrast to give a readable display.

Anritsu

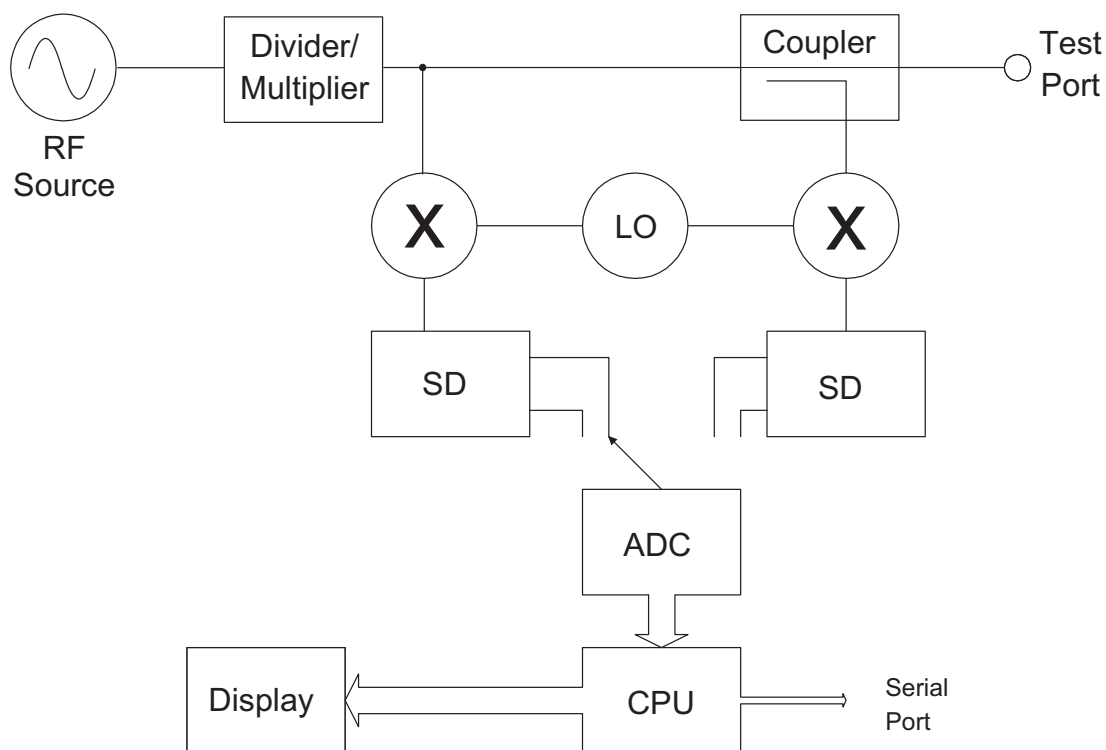

Figure 2. Site Master Block Diagram

4. FREQUENCY ACCURACY

The following test can be used to verify the CW frequency accuracy of the Site Master. Measurement calibration of the Site Master is *not* required for this test.

a. Equipment Required:

- Spectrum Analyzer Anritsu Model MS2663C or equivalent

b. Procedure:

1. Press and hold the **ESCAPE/CLEAR** key, then press the **ON/OFF** key to turn on the Site Master. (This sets the instrument to the factory preset state.)

NOTE

Before continuing, allow a five minute warm up for the internal circuitry to stabilize.

2. Press the **FREQ/DIST** key, then press the **F1** soft key and set F1 to 1000 MHz, then press the **ENTER** key.
3. Press the **F2** soft key, set F2 to 1000 MHz, then press the **ENTER** key.
4. Connect the RF cable from the Site Master Reflection Test Port to the RF Input on the MS2663C or equivalent.
5. Set up the Spectrum Analyzer as follows:
 - (a) Press the **Preset** key, then select **Preset All** (F1).
 - (b) Press the **Frequency** key.
 - (c) Press the **1** key and then the **GHz** key to change the Center Frequency to 1 GHz.
 - (d) Press the **Span** key.
 - (e) Press the **2, 5, 0,** and **kHz** keys sequentially to change the Frequency Span to 250 kHz.
 - (f) Press the **RBW** key.

- (g) Press the **3, 0** and **kHz** keys sequentially to change the RBW to 30 kHz.
 - (h) Press the **VBW** key.
 - (i) Press the **Filter Off** soft key (F3) to turn the VB filter off.
 - (j) Press the **Amplitude** key.
 - (k) Press the **0**, and **dBm** keys sequentially to change the Reference Level to 0 dBm.
 - (l) Press the **Log Scale** soft key (F5)
 - (m) Select **2 dB/Div** (F3) and the press the **return** soft key (F6).
 - (n) Press the **Marker** key.
 - (o) Press the **Zone Width** soft key (F5).
 - (p) Select the **Spot** soft key (F1).
6. On the Site Master, press the **SYS** key, the **OPTIONS** soft key and then the **FIXED CW** soft key to turn Fixed CW on.

NOTE:

If the Site Master has gone into the hold mode, press the **RUN/HOLD** key to return to normal mode.

- 7. When a sweep is completed, a smooth response should appear on the Spectrum Analyzer.
- 8. Press the **Marker Peak Search** key on the Spectrum Analyzer. Verify that the marker peak readout value is 1000 MHz \pm 75 kHz.
- 9. On the Site Master, press the **SYS** key, the **OPTIONS** soft key and then the **FIXED CW** soft key to turn Fixed CW Off.

5. RETURN LOSS VERIFICATION

The following test can be used to verify the accuracy of return loss measurements. Measurement calibration of the Site Master is required for this test.

a. Equipment Required:

- 20 dB offset, Anritsu SC5270
- 6 dB offset, Anritsu SC5237
- Open/Short, Anritsu 22N50
- 50 Ohm Termination, Anritsu 28N50-2 or SM/PL

b. Procedure:

1. Press and hold the **ESCAPE/CLEAR** key, then press the **ON/OFF** key to turn on the Site Master. (This sets the instrument to the factory preset state.)

NOTE

Before continuing, allow a five minute warm up for the internal circuitry to stabilize.

2. Press the **MODE** soft key.
3. Use the Up/Down Arrow key to highlight **RETURN LOSS**, then press **ENTER**.
4. Press the **START CAL** key.
5. Follow the instructions on the screen to perform a calibration using a 22N50 Open/Short and 28N50-2 or SM/PL Termination.
6. Connect the 20 dB offset to the Refl Test Port and verify that the reading is:
 - S113B: 20 dB \pm 1.7 dB
 - S331B: 20 dB \pm 1.7 dB
7. Connect the 6 dB offset to the Refl Test Port and verify that the reading is:
 - S113B: 6 dB \pm 1.2 dB
 - S331B: 6 dB \pm 1.2 dB.

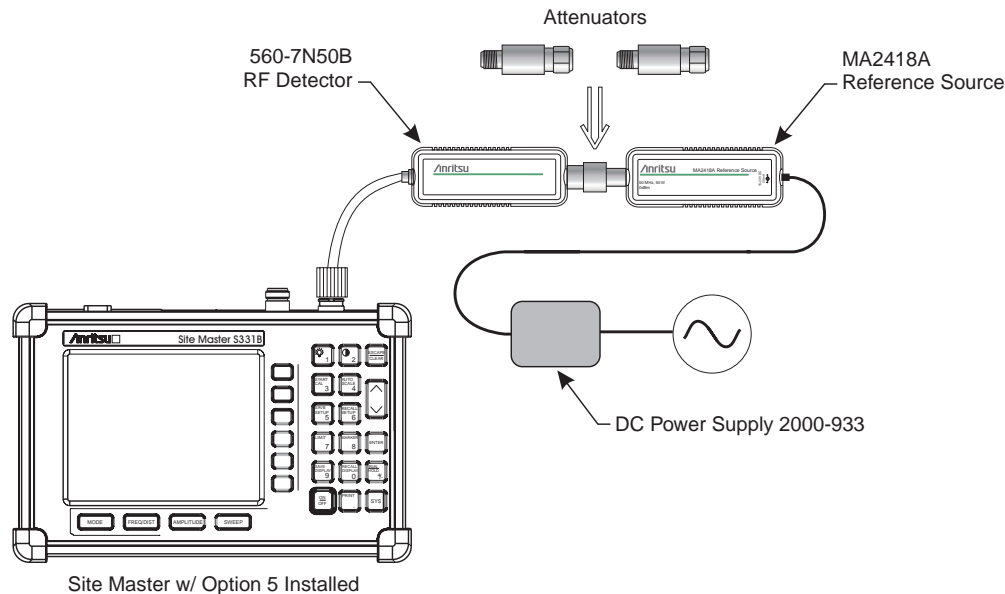

Figure 3. Power Monitor Verification

6. POWER MONITOR VERIFICATION

If the Power Monitor (Option 5) is installed in the Site Master, the following test can be used to verify the accuracy of the power measurements. Measurement calibration of the Site Master is **not** required for this test.

a. Equipment Required:

- RF Detector, 10 MHz to 20 GHz, Anritsu 560-7N50B
- 10 dB Attenuator, Weinschel 1R-10
- 30 dB Attenuator, Weinschel 1R-30
- RF Reference Source, 0.050 GHz, Anritsu MA2418A
- DC Power Supply, Anritsu 2000-933

b. Procedure

1. Connect the DC power supply to the MA2418A Reference Source. (Refer to Figure 3, page 4.)
2. Connect the MA2418A Reference Source to the input of the 560-7N50B RF detector.
3. Connect the RF Detector output to the RF Detector input of the Site Master.
4. Connect the DC power supply to the appropriate line voltage to supply power to the MA2418A Reference Source.
5. Press and hold the **ESCAPE/CLEAR** key, then press the **ON/OFF** key to turn on the Site Master. (This sets the instrument to the factory preset state.)
6. Press the **MODE** soft key.
7. Use the Up/Down Arrow key to highlight **POWER MONITOR**, then press **ENTER**.
8. Press the **ZERO** soft key to zero the power monitor. When complete, **ZERO ADJ:ON** is displayed in the message area.
9. Verify that the power monitor reading is $0.0 \text{ dBm} \pm 1 \text{ dB}$.
10. Connect the output of the MA2418A Reference Source to the two attenuators so as to add 40 dB of attenuation (Figure 3).
11. Connect the MA2418A Reference Source and the attenuators to the input of the 560-7N50B RF detector.
12. Verify that the power monitor reading is now $-40.0 \text{ dBm} \pm 2 \text{ dB}$.

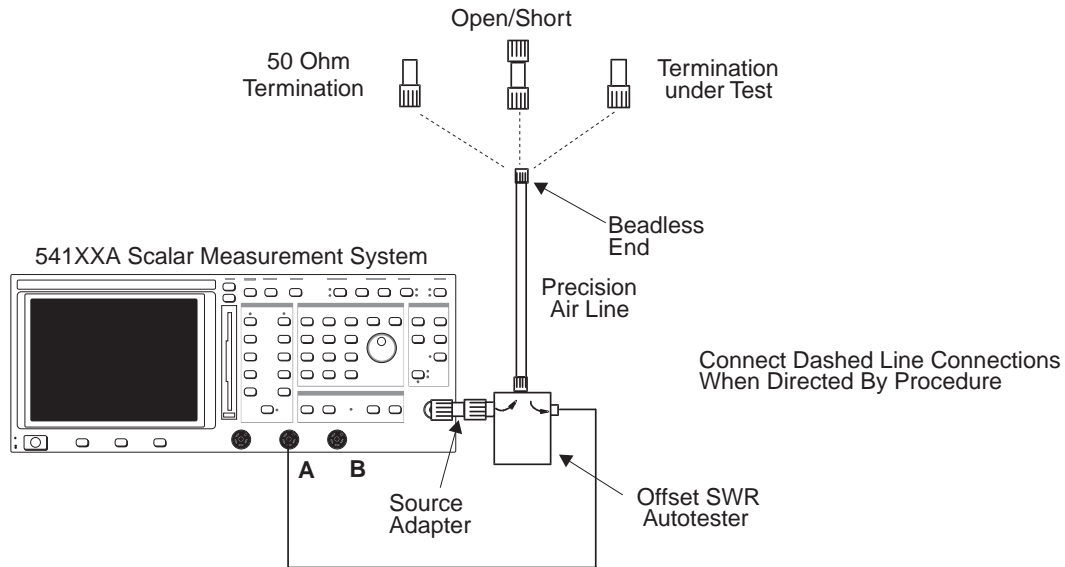

Figure 4. 541XXA Precision Return Loss Setup

7. TERMINATION VERIFICATION

This test verifies the accuracy of the Site Master SM/PL termination using the precision return loss mode of the 541XXA Scalar Measurement System. Measurements of terminations using this mode provide results that are traceable to the NIST (National Institute of Standards and Technology) standards for the precision airline.

a. Equipment Required:

- Scalar Measurement System, Anritsu 541XXA
- Offset SWR Autotester, Anritsu 560-97A50-20
- Precision Airline, Anritsu 18N50
- Open/Short, Anritsu 22N50
- 50 Ohm Termination, Anritsu 26N50
- Source Adapter, Anritsu 34NN50A

b. Procedure

1. Connect the test equipment as shown in Figure 4, page 5.
2. Press the **Power** key on the 541XXA to On.
3. Press the **System Menu** key.

4. Using the Menu up-down keys: Highlight **RESET**, then press the **Select** key.
5. At the **RESET MENU** display, use the Menu up-down keys to highlight **RESET TO FACTORY DEFAULTS**, then press the **Select** key.
6. Set the signal source for the frequency range as follows:
 - (a) Press the **Frequency** key.
 - (b) Using the Data Entry Keypad or Data Entry Knob, set the Start frequency to 0.01 GHz. Press the **Enter** key.
 - (c) Using the Data Entry Keypad or Data Entry Knob, set the Stop frequency to 4.0 GHz. Press the **Enter** key.
7. Press the Channel 2 Display On/Off key to Off.
8. Press the Channel 1 Menu key.
9. Using the Menu up-down keys: Highlight **PRECISION RL**, then press the **Select** key.
10. At the **PRECISION RETURN LOSS** menu display, use the Menu up-down keys to highlight **FINAL**, then press the **Select** key.

11. Press the **Calibration** key.
12. At the CALIBRATION menu display, use the Menu up-down keys to highlight **START CAL**, then press the **Select** key.
13. At the PRECISION RETURN LOSS CALIBRATION menu display prompt, connect the Offset SWR Autotester to Input A, if you have not done so yet.
14. Connect the precision air line to the Offset SWR Autotester test port. Position the air line pointing vertically upward. Downward or horizontal positions make connector pin alignment difficult.

NOTE

Ensure that the beadless end of the precision airline is at the measurement connection point.

15. Press the **Select** key when ready.
16. At the PRECISION RETURN LOSS CALIBRATION menu prompt, connect the Open to the beadless end of the air line. Press the **Select** key to start the calibration.
17. Verify that the display resembles that shown in Figure 5.

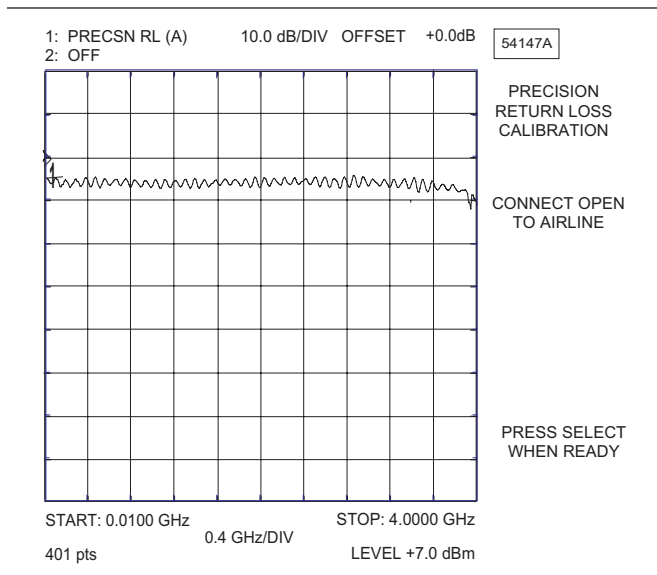

Figure 5. Example of a Good Connection

CAUTION

During both calibration and measurement, be sure to properly align the beadless connector of the airline. When the connectors are mis-aligned, a spike will usually be visible on the display.

18. At the next menu prompt, remove the Open and connect the Short to the beadless end of the airline. Press the **Select** key to start the calibration process.
19. At the next menu prompt, remove the Short and connect the 50 Ohm Termination to the beadless end of the air line. Press the **Select** key to start the calibration process.
20. When the calibration is complete, remove the 50 Ohm Termination.
21. Connect the SM/PL termination to the beadless end of the air line and press the **Select** key to begin the measurement.
22. Observe that the waveform displayed resembles that shown in Figure 6.

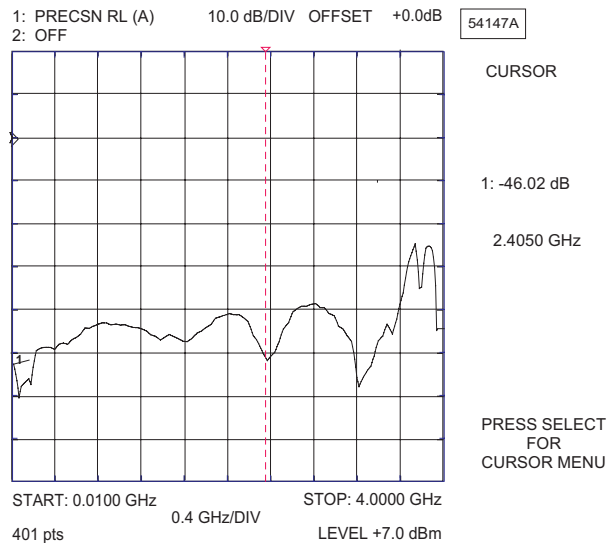

Figure 6. Direct Readout of the Precision Return Loss

23. Press the **Cursor On/Off** key to On.
24. Observe the Cursor menu readout. The minimum return loss reading for the SM/PL termination should be 42 dB.

8. BATTERY PACK REMOVAL AND REPLACEMENT

This procedure provides instructions for removing and replacing the Site Master battery pack.

1. With the Site Master standing upright on a stable surface, locate the battery access door (Figure 7).

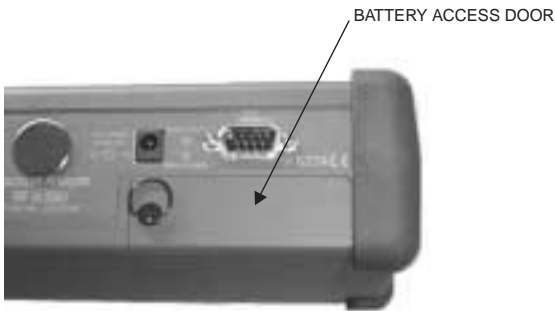

Figure 7. Battery Access Door Location

2. Lift up the access door handle and rotate it 90 degrees counterclockwise, as illustrated in Figure 8.

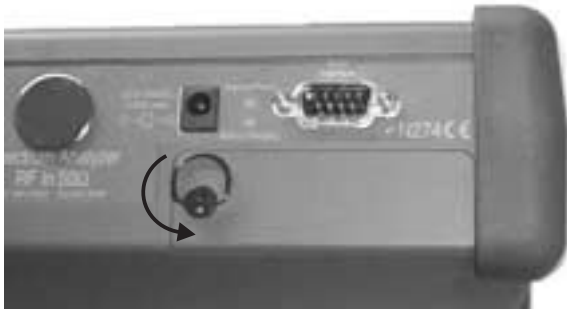

Figure 8. Rotate the Battery Access Door Handle

3. Lift the door and remove, as illustrated in Figure 11.
4. Grasp the battery lanyard and pull the battery straight up and out of the unit, as illustrated in Figure 9.

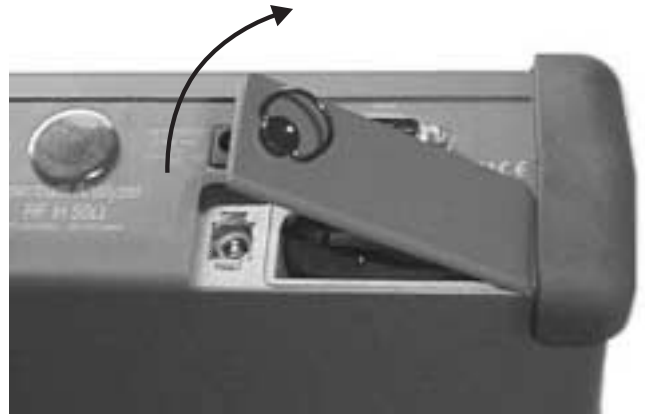

Figure 11. Removing the Battery Access Door

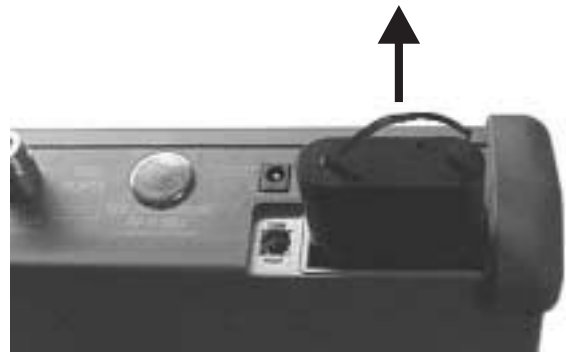

Figure 9. Removing the Battery

5. Replacement is the opposite of removal. Note the orientation of the battery contacts, and be sure to insert the new battery with the contacts facing the rear of the unit (Figure 10).



Figure 10. Battery Orientation

9. BATTERY INFORMATION

The following information relates to the care and handling of the Site Master battery, and NiMH batteries in general.



Figure 12. Site Master S113B/S331B Battery

- The Nickel Metal Hydride (NiMH) battery supplied with the Site Master is shipped in a discharged state. Before using the Site Master, the internal battery must first be charged for three hours, either in the Site Master or in the optional battery charger (Anritsu part number: 2000-1029).
- Use only Anritsu approved battery packs.
- Recharge the battery only in the Site Master or in an Anritsu approved charger.
- With a new NiMH battery, full performance is achieved after three to five complete charge and discharge cycles.
- When the Site Master or the charger is not in use, disconnect it from the power source.
- Do not charge batteries for longer than 24 hours; overcharging may shorten battery life.
- If left unused a fully charged battery will discharge itself over time.
- Temperature extremes will affect the ability of the battery to charge: allow the battery to cool down or warm up as necessary before use or charging.
- Discharge an NiMH battery from time to time to improve battery performance and battery life.
- The battery can be charged and discharged hundreds of times, but it will eventually wear out.

- The battery may need to be replaced when the operating time between charging becomes noticeably shorter than normal.
- Never use a damaged or worn out charger or battery.
- Storing the battery in extreme hot or cold places will reduce the capacity and lifetime of the battery.
- Never short-circuit the battery terminals.
- Do not drop, mutilate or attempt to disassemble the battery.
- Do not dispose of batteries in a fire!
- Batteries must be recycled or disposed of properly. Do not place batteries in household garbage.
- Always use the battery for its intended purpose only.

10. FRONT PANEL ASSEMBLY REMOVAL AND REPLACEMENT

This procedure provides instructions for removing and replacing the Site Master front panel assembly. With the front panel assembly removed, the LCD display, keypad PCB, keypad membrane, and main PCB assemblies can be removed and replaced.

1. Place the Site Master face up on a work surface.
2. Remove the four rubber corner bumpers by carefully sliding the bumpers off of the case corners (Figure 16).



Figure 13. Removing the Corner Bumpers

3. With the bumpers removed, the access holes for the case screws are revealed. Use a Philips screwdriver to remove the four screws securing the two halves of the Site Master case together.
4. Carefully lift up on the right side (as viewed from the front) of the front half of the case and begin to separate the two halves.

CAUTION

Do not force or pull the two halves of the case apart as there are delicate cables attached between the two halves that must be disconnected first.

5. Carefully depress the latch tab and disconnect the LCD display cable from J12 on the main PCB.

6. Carefully disconnect the keypad interface cable from J1 on the main PCB.
7. Carefully disconnect the LCD display backlight cable from J15 on the main PCB.

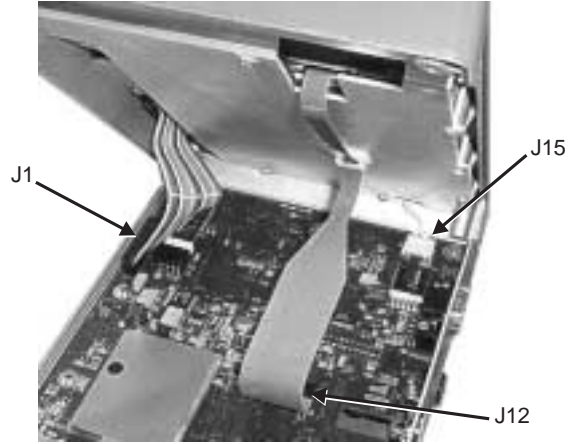

Figure 15. Site Master Front Panel Cable Connections

8. Remove the front panel assembly.
9. Reverse the above steps to replace the front panel assembly.

NOTE

The corner bumpers only mount one way. That is, the raised area inside one end of the bumper (Figure 14) is made to conform to the contour of the front cover only.



Figure 14. Corner Bumper Detail

11. LCD ASSEMBLY REPLACEMENT

This procedure provides instructions for removing and replacing the Liquid Crystal Display (LCD) once the front panel assembly has been separated from the Site Master.

1. Remove the front panel assembly as directed in section 10.
2. Place the front panel assembly face down on a protected work surface.
3. Remove the 14 Phillips screws that attach the backing plate to the front panel assembly.
4. Release the LCD display cable from the retaining clip on the front panel backing plate.

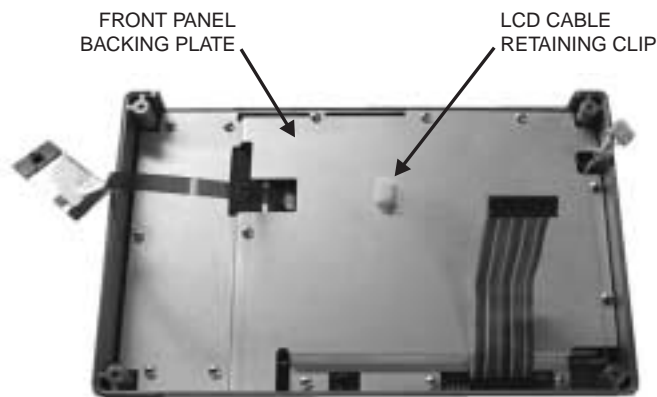

Figure 16. Front Panel Backing Plate

5. Remove the front panel backing plate, carefully feeding the LCD cable through the access hole to avoid damage to the cable or connector.
6. Remove the rubber cushion pad from the LCD assembly and remove the assembly.
7. Reverse the above steps to install the replacement assembly.

12. KEY PAD PCB REPLACEMENT

This procedure provides instructions for removing and replacing the key pad PCB.

1. Remove the front panel assembly as directed in section 10.
2. Place the front panel assembly face down on a protected work surface.
3. Remove the 14 Phillips screws that attach the backing plate to the front panel assembly.
4. Release the LCD display cable from the retaining clip on the front panel backing plate (Figure).
5. Remove the front panel backing plate, carefully feeding the LCD cable through the access hole to avoid damage to the cable or connector.
6. Remove the rubber cushion pad from the keypad PCB and remove the PCB.

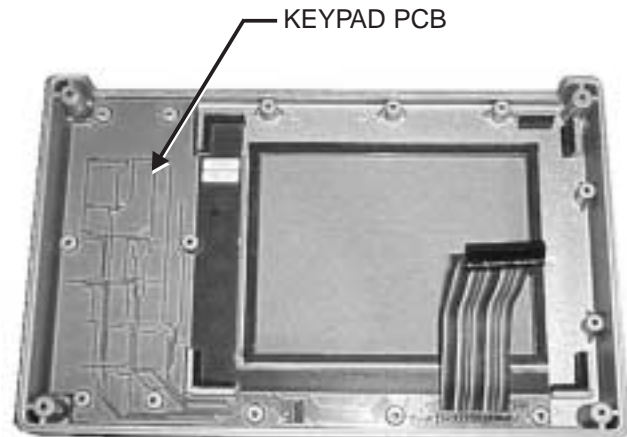

Figure 17. Front Panel Keypad PCB Location

7. Reverse the above steps to install the replacement assembly.

13. KEY PAD MEMBRANE REPLACEMENT

This procedure provides instructions for replacing the key pad membrane.

1. Remove the front panel assembly as directed in section 10.
2. Remove the key pad PCB as directed in section 12.
3. Remove the keypad membrane by gently pulling the membrane up and out of the holes in the front panel.

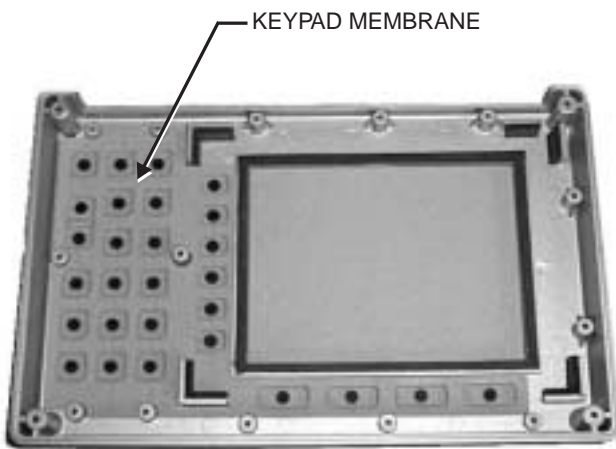

Figure 18. Front Panel Keypad Membrane

4. Reverse the above steps to install the replacement membrane.

14. MAIN PCB ASSEMBLY REPLACEMENT

This procedure provides instructions for replacing the main PCB assembly with the connector panel attached.

1. Remove the front panel assembly as directed in section 10.
2. Disconnect the battery connector from J13 on the main PCB.
3. Remove the three PCB mounting screws and remove the PCB assembly with the connector panel attached.

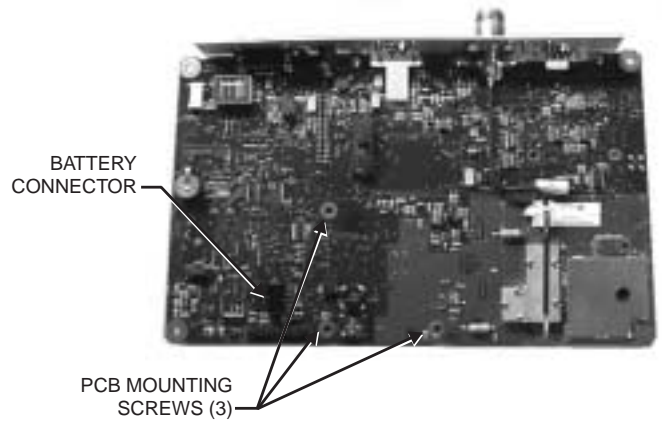

Figure 19. Main PCB

4. Reverse the above steps to install the new main PCB.

NOTE

The main PCB connector panel fits into grooves in the two halves of the Site Master case. Make sure the panel is correctly aligned with the grooves before reassembling the two halves together.

15. REPLACEABLE PARTS

Replaceable parts for the Site Master Model S113B/S331B are listed below.

Table 1. *Replaceable Parts List*

Part Number	Description	Qty
Accessories		
10580-00028	User's Guide, Site Master S113B/S331B	1
10580-00035	Programming Manual, Site Master S113B/S331B (available on disk only)	1
2300-347	Software Tools, Site Master	1
40-115	Power Supply	1
2000-1029	Battery Charger	
22N50	Precision Short/Open, N Male	1
SM/PL	Connector, RF Termination	1
OSLN50LF	Connector, RF Termination	1
806-62	Cable Assy, Cig Plug, Female	1
800-441	Serial Interface Cable Assy	1
48258	Soft Carrying Case	1
Replaceable Parts		
510-87	N-Connector	1
551-152	Option 05 Input Connector	1
15-102	Liquid Crystal Display Assy	1
633-27	Rechargeable Battery, NiMH	1
ND50705	Main PCB Assembly, S113B	1
ND50713	Main PCB Assembly, S331B	1
ND52638	Main PCB Assembly, S113B with Option 05	1
ND52639	Main PCB Assembly, S331B with Option 05	1
ND53250	Option 05 PCB Assembly	1
48267	Bracket for Option 05 Assembly	1
47812-3	Keypad PCB Assy	1
46649-1	Membrane Keypad, Main	1

Part Number	Description	Qty
Hardware		
900-861	Pan Head Screw, 4-20, 0.365	15
900-869	Screw, 4-40, 0.875	4
900-720	Screw, 4-40, 0.187	3
900-697	Screw, 4-40, 0.312	3
785-929	M-F Stand off, 4-40, 11/16	3
900-326	Kep Nut, 4-40, 0.187	8
790-516	Hole Plug, 0.6875L	1
790-42	Hole Plug, 0.625	1
761-79	Cap Vinyl, Black, round	1
Case Parts		
46652-1	Top Case only	1
46665	Top Case w/ hardware	1
46653-1	Bottom Case only	1
46664	Bottom Case w/ hardware	1
48231-1	Battery Door	1
790-509 790-510 790-511	Battery Door Latch (3 pieces)	1
46655	Case Corner Bumpers	4
46662	LCD Retainer Plate	1
48241	Foam, LCD Corners	8
48278	Foam, LCD Window	1
46659	Foam, LCD Backing	1
46661	Foam, Keypad Backing	1
48246	Foam, Battery Door	4
48271	Foam, Battery Compartment	1
720-19	Cable Clamp	1
790-515	Spring, Battery Compartment	1
48247	ID Label, Model S113B	1
48250	ID Label, Model S331B	1

Table 2. Anritsu Service Centers

UNITED STATES

ANRITSU COMPANY
685 Jarvis Drive
Morgan Hill, CA 95037-2809
Telephone: (408) 776-8300
1-800-ANRITSU
FAX: 408-776-1744

ANRITSU COMPANY
10 New Maple Ave., Unit 305
Pine Brook, NJ 07058
Telephone: (201) 227-8999, 1-800-ANRITSU
FAX: 201-575-0092

ANRITSU COMPANY
1155 E. Collins Blvd
Richardson, TX 75081
Telephone: 1-800-ANRITSU
FAX: 972-671-1877

AUSTRALIA

ANRITSU PTY. LTD.
Unit 3, 170 Foster Road
Mt Waverley, VIC 3149
Australia
Telephone: 03-9558-8177
FAX: 03-9558-8255

BRAZIL

ANRITSU ELECTRONICA LTDA.
Praia de Botafogo, 440, Sala 2401
CEP22250-040, Rio de Janeiro, RJ, Brasil
Telephone: 021-28-69-141
FAX: 021-53-71-456

CANADA

ANRITSU INSTRUMENTS LTD.
215 Stafford Road, Unit 102
Nepean, Ontario K2H 9C1
Telephone: (613) 828-4090
FAX: (613) 828-5400

CHINA

INSTRIMPEX
Anritsu Product Service Station
No. 1515 Beijing Fortune Building
5 Dong San Huan Bei Lu Chao Yang-qu
Beijing, China
Telephone: 10-6590-9230
FAX: 10-6590-9235

FRANCE

ANRITSU S.A
9 Avenue du Quebec
Zone de Courtaboeuf
91951 Les Ulis Cedex
Telephone: 016-44-66-546
FAX: 016-44-61-065

GERMANY

ANRITSU GmbH
Grafenberger Allee 54-56
D-40237 Dusseldorf, Germany
Telephone: 0211-68550
FAX: 0211-68555

INDIA

MEERA AGENCIES (P) LTD.
A-23 Hauz Khas
New Delhi 110 016
Telephone: 011-685-3959
FAX: 011-686-6720

ISRAEL

TECH-CENT, LTD.
Haarad St. No. 7, Ramat Haahayal
Tel-Aviv 69701
Telephone: (03) 64-78-563
FAX: (03) 64-78-334

ITALY

ANRITSU Sp.A
Roma Office
Via E. Vittorini, 129
00144 Roma EUR
Telephone: (06) 50-22-666
FAX: (06) 50-22-4252

KOREA

ANRITSU CORPORATION LTD.
#901 Daero Bldg. 26-5
Yeoido Dong, Youngdeungpo
Seoul Korea 150 010
Telephone: 02-782-7156
FAX: 02-782-4590

JAPAN

ANRITSU CORPORATION
1800 Onna Atsugi-shi
Kanagawa-Prf. 243 Japan
Telephone: 0462-23-1111
FAX: 0462-25-8379

SINGAPORE

ANRITSU (SINGAPORE) PTE LTD.
3 Shenton Way #24-03
Shenton House
Singapore 0106
Telephone: 2265206
FAX: 2265207

SOUTH AFRICA

ETECSA
12 Surrey Square Office Park
330 Surrey Avenue
Ferndale, Randburt, 2194
South Africa
Telephone: 011-11-787-7200
FAX: 011-11-787-0446

SWEDEN

ANRITSU AB
Botivud Center
S-1585
Stockholm, Sweden
Telephone: (08) 534-717-00
FAX: (08) 534-717-30

TAIWAN

ANRITSU CO., LTD.
8F, No. 96, Section 3
Chien Kuo N. Road
Taipei, Taiwan, R.O.C.
Telephone: (02) 515-6050
FAX: (02) 509-5519

UNITED KINGDOM

ANRITSU LTD.
200 Capability Green
Luton, Bedfordshire
LU1 3LU, England
Telephone: 015-82-41-88-53
FAX: 015-82-31-303

NOTES

Anritsu