



Site Master  
Model SM5559  
Antenna and  
Cable Analyzer

*User's Guide*

Hand-Held Tester for Transmission Lines  
and other RF Components



## **WARRANTY**

The Anritsu product(s) listed on the title page is (are) warranted against defects in materials and workmanship for one year from the date of shipment. Anritsu's obligation covers repairing or replacing products which prove to be defective during the warranty period. Buyers shall prepay transportation charges for equipment returned to Anritsu for warranty repairs. Obligation is limited to the original purchaser. Anritsu is not liable for consequential damages.

## **LIMITATION OF WARRANTY**

The foregoing warranty does not apply to Anritsu connectors that have failed due to normal wear. Also, the warranty does not apply to defects resulting from improper or inadequate maintenance by the Buyer, unauthorized modification or misuse, or operation outside the environmental specifications of the product. No other warranty is expressed or implied, and the remedies provided herein are the Buyer's sole and exclusive remedies.

## **TRADEMARK ACKNOWLEDGMENTS**

MS-DOS, Windows, Windows 95, Windows NT, and Windows 98 are registered trademarks of the Microsoft Corporation. Anritsu and Site Master are trademarks of Anritsu Company.

## **NOTICE**

Anritsu Company has prepared this manual for use by Anritsu Company personnel and customers as a guide for the proper installation, operation and maintenance of Anritsu Company equipment and computer programs. The drawings, specifications, and information contained herein are the property of Anritsu Company, and any unauthorized use or disclosure of these drawings, specifications, and information is prohibited; they shall not be reproduced, copied, or used in whole or in part as the basis for manufacture or sale of the equipment or software programs without the prior written consent of Anritsu Company.

# DECLARATION OF CONFORMITY

**Manufacturer's Name:** ANRITSU COMPANY

**Manufacturer's Address:** Microwave Measurements Division  
490 Jarvis Drive  
Morgan Hill, CA 95037-2809  
USA

declares that the product specified below:

**Product Name:** Site Master

**Model Number:** S113B – Version SM5559

conforms to the requirement of:

EMC Directive 89/336/EEC as amended by Council Directive 92/31/EEC & 93/68/EEC  
Low Voltage Directive 73/23/EEC as amended by Council directive 93/68/EEC

## **Electromagnetic Interference:**

**Emissions:** CISPR 11:1990/EN55011:1991 Group 1 Class A

**Immunity:** EN 61000-4-2:1995/EN50082-1:1997 - 4kV CD, 8kV AD  
EN 61000-4-3:1997/EN50082-1:1997 - 3V/m  
ENV 50204/EN50082-1:1997 – 3V/m  
EN 61000-4-4:1995/EN50082-1:1997 - 0.5kV SL, 1kV PL  
EN 61000-4-5:1995/EN50082-1:1997 - 1kV L-L, 2kV L-E

## **Electrical Safety Requirement:**

**Product Safety:** The Product Complies when used with Company supplied Power Supply (tested to EN 60950)



Corporate Quality Director

Morgan Hill, CA

6-MAR-00

Date

European Contact: For Anritsu product EMC & LVD information, contact Anritsu LTD, Rutherford Close, Stevenage Herts, SG1 2EF UK, (FAX 44-1438-740202)

# *Table of Contents*

---

<b>Chapter 1 - General Information</b>	<b>1-1</b>
Introduction . . . . .	1-1
Description . . . . .	1-1
Standard Accessories . . . . .	1-1
Basic Configuration . . . . .	1-2
Options and Accessories . . . . .	1-2
Performance Specifications . . . . .	1-3
Preventive Maintenance . . . . .	1-6
Calibration . . . . .	1-7
Annual Verification. . . . .	1-7
<b>Chapter 2 - Getting Started</b>	<b>2-1</b>
Introduction. . . . .	2-1
Charging a New Battery . . . . .	2-1
Charging the Battery in the Site Master . . . . .	2-1
Charging the Battery in the Optional Charger. . . . .	2-1
Battery Charge Indicator . . . . .	2-2
Discharging the NiMH Battery . . . . .	2-3
Battery Life . . . . .	2-3
Important Battery Information . . . . .	2-4
<b>Chapter 3 - Functions and Operations</b>	<b>3-1</b>
Introduction. . . . .	3-1
Front Panel Overview . . . . .	3-1
Test Connector Panel. . . . .	3-2
Keypad Controls . . . . .	3-3
Soft Keys . . . . .	3-6
Power Monitor Menu . . . . .	3-19
Printing. . . . .	3-20
Printing a Screen . . . . .	3-20
Printer Switch Settings . . . . .	3-21
Symbols . . . . .	3-22
Self Test . . . . .	3-22
Error Codes . . . . .	3-23
Self Test Errors . . . . .	3-23
Range Errors . . . . .	3-24
Using the Soft Carrying Case. . . . .	3-26

<b>Chapter 4 - Measurements</b>	<b>4-1</b>
<b>Introduction</b>	<b>4-1</b>
<b>Measurement Functions</b>	<b>4-1</b>
<b>Power On Procedure</b>	<b>4-2</b>
<b>Calibration Procedure</b>	<b>4-2</b>
Selecting the Frequency Range	4-3
Performing a Calibration	4-3
Setting the Amplitude Scale	4-3
Saving the Setup	4-4
Recalling a Setup	4-4
Saving a Display to Memory	4-4
Recalling a Display From Memory	4-4
<b>SWR (Return Loss) and Cable Loss Measurement</b>	<b>4-6</b>
Required Equipment	4-6
Device-Under-Test Specification	4-6
Procedure	4-6
Selecting the Measurement Mode	4-6
Selecting the Frequency Range	4-6
Performing a Calibration	4-7
SWR or Return Loss Measurement	4-8
Set the Amplitude Scale and Limit Line	4-8
Setting the Markers	4-9
<b>Cable Loss Measurement</b>	<b>4-10</b>
Setting the Amplitude Scale	4-10
Setting the Markers	4-10
<b>DTF Measurement</b>	<b>4-12</b>
Required Equipment	4-12
Device-Under-Test Specification	4-12
Procedure	4-12
Selecting the Measurement Mode	4-12
Performing a Calibration	4-13
DTF Measurement (Determining the Length of the Cable)	4-14
Setting the Amplitude Scale	4-14
Setting the Marker	4-14
DTF Measurement (Determining the quality of the cable.)	4-16
Setting the Amplitude Scale	4-16
Setting the Markers	4-16
<b>Making Power Measurements</b>	<b>4-18</b>
Entering Power Monitor Mode	4-18
Zeroing the Power Monitor	4-18
Measuring High Input Power Levels	4-18
Displaying Power in dBm and Watts	4-18
Displaying Relative Power	4-18

<b>Chapter 5 - Software Tools Program</b>	<b>5-1</b>
Description . . . . .	5-1
Requirements . . . . .	5-1
Communication Port Setting. . . . .	5-1
Changing COM Port Settings–Windows 95/98/NT . . . . .	5-1
Software Installation . . . . .	5-3
Plot Capture. . . . .	5-3
Capture multiple traces to a database. . . . .	5-4
Capture single or multiple traces to PC screen. . . . .	5-4
Custom Cable List Uploading and Downloading. . . . .	5-5
Uploading a Cable List to the Site Master Custom Cable Table . . . . .	5-5
Downloading a Cable List from the Site Master Custom Cable Table . . . . .	5-5
Saving a Custom Cable List . . . . .	5-5
Program Operation. . . . .	5-6
Fault Location Software . . . . .	5-6
Smith Chart Software . . . . .	5-6
Saving a Plot as a Windows Metafile or as a Spreadsheet File . . . . .	5-7
Pasting a Plot in Graphic or Spreadsheet Format . . . . .	5-7
Saving Data to a Database . . . . .	5-7
Mouse Function. . . . .	5-7
“Drag-n-Drop” . . . . .	5-8
“Click-n-Drag” . . . . .	5-8
Printing . . . . .	5-8
<b>Appendix A - Reference Data</b>	<b>A-1</b>
Coaxial Cable Technical Data. . . . .	A-1





# Chapter 1

## General Information

### Introduction

This chapter provides a description, performance specifications, optional accessories, preventive maintenance, and calibration requirements for the Site Master model SM5559. Throughout this manual, the term Site Master will refer only to the model SM5559.

<u>Model</u>	<u>Frequency Range</u>
SM5559	5 to 1600 MHz



### Description

The Site Master is a hand held standing wave ratio/return loss (SWR/RL), and distance-to-fault (DTF) measurement instrument that includes a built-in synthesized signal source. All models include a keypad to enter data and a liquid crystal display (LCD) to provide graphic indications of SWR or RL over the selected frequency range and selected distance. The Site Master is capable of up to 2.5 hours of continuous operation from a fully charged field-replaceable battery and can be operated from a 12.5 Vdc source. Built-in energy conservation features can be used to extend battery life over an eight-hour work day.

The Site Master is designed for measuring SWR, return loss, or cable insertion loss and locating faulty RF components in antenna systems. Power monitoring is available as an option. The displayed trace can be scaled or enhanced with frequency markers or a limit line. A menu option provides for an audible “beep” when the limit value is exceeded. To permit use in low-light environments, the LCD can be back lit using a front panel key.

### Standard Accessories

The Software Tools PC-based software program provides a database record for storing measurement data. Site Master Software Tools can also convert the Site Master display to a Microsoft Windows™ 95/98/NT workstation graphic. Measurements stored in the Site Master internal memory can be downloaded to the PC using the included null-modem serial cable. Once stored, the graphic trace can be displayed, scaled, or enhanced with markers and limit lines. Historical graphs can be overlaid with current data, and underlying data can be extracted and used in spreadsheets or for other analytical tasks.

The Site Master Software Tools program also performs DTF (Distance To Fault) and Fault Location.

## Basic Configuration

The SM5559 is packaged with the following items:

- Soft Carrying Case
- AC-DC Adapter
- Automotive Cigarette Lighter 12 Volt DC Adapter,
- CDROM disk containing the Software Tools program. This program contains Fault Location (DTF) and Smith Chart functions.
- Serial Interface Cable (null modem type)
- One year Warranty (includes battery, firmware, and software)
- User's Guide

## Options and Accessories

- Option 5 — RF Wattmeter Power Monitor
- RF Detector, 1 to 3000 MHz, N(m) input connector, 50 Ohms, Part No. 5400-71N50
- Anritsu Precision N (f) Open/Short/Load, 42 dB, Part No. OSLNF50LF
- Anritsu Precision N (m) Open/Short/Load, 42 dB, Part No. OSLN50LF
- Anritsu Precision N (m) Short/Open, Part No. 22N50
- Anritsu Precision N (f) Short/Open, Part No. 22NF50
- Site Master Precision N (m) Load, 42 dB, Part No. SM/PL
- Site Master Precision N (f) Load, 42 dB, Part No. SM/PLNF
- 7/16 (m) Precision Open/Short/Load, Part No. 2000-767
- 7/16 (f) Precision Open/Short/Load, Part No. 2000-768
- Adapter, Precision N (m) to N (m), Part No. 34NN50A
- Adapter, Precision N (f) to N (f), Part No. 34NFN50
- Adapter, 7/16 (f) to N (m), Part No. 510-90
- Adapter, 7/16 (f) to N (f), Part No. 510-91
- Adapter, 7/16 (m) to N (m), Part No. 510-92
- Adapter, 7/16 (m) to N (f), Part No. 510-93
- Adapter, 7/16 DIN (m) to 7/16 DIN (m), Part No. 510-96
- Adapter, 7/16 DIN (f) to 7/16 DIN (f), Part No. 510-97
- Armored Test Port Extension Cable, 1.5 meter, N (m) to N (f), Part No. 15NNF50-1.5A
- Armored Test Port Extension Cable, 3.0 meter, N (m) to N (f), Part No. 15NNF50-3.0A
- Armored Test Port Extension Cable, 5.0 meter, N (m) to N (f), Part No. 15NNF50-5.0A

- Armored Test Port Extension Cable, 1.5 meter, N (m) to N (m), Part No. 15NN50-1.5A
- Armored Test Port Extension Cable, 3.0 meter, N (m) to N (m), Part No. 15NN50-3.0A
- Armored Test Port Extension Cable, 5.0 meter, N (m) to N (m), Part No. 15NN50-5.0A
- Armored Test Port Extension Cable, 1.5 meter, N (m) to 7/16 DIN (f), Part No. 15NDF50-1.5A
- Armored Test Port Extension Cable, 1.5 meter, N (m) to 7/16 DIN (m), Part No. 15ND50-1.5A
- Transit Case for Site Master, Part No. 760-215A
- HP Deskjet 340 Printer, Part No. 2000-766
- Serial-to-Parallel Converter Cable (use with the HP 340 Printer), Part No. 2000-753
- Seiko DPU-414 Thermal Printer, Part No. 2000-754 (U.S.) or 2000-761 (Europe)
- US Adapter (use with the DPU-414 Printer), Part No. 2000-1002
- Europe Adapter (use with the DPU-414 Printer) Part No. 2000-1003
- Battery Pack (use with the DPU-414 Printer) Part No. 2000-1004
- Serial Interface Cable (use with the DPU-414 Printer), Part No. 2000-10012
- Thermal Paper (use with the DPU-411/DPU-414 Printer), Part No. 2000-755
- Rechargeable Battery, NiMH Part No. 633-27
- Battery Charger, NiMH only Part No. 2000-1029

## **Performance Specifications**

Performance specifications are provided in Table 1-1, on the following pages.

## Chapter 1 General Information

Table 1-1. Performance Specifications (1 of 2)

Specifications are valid when the unit is calibrated at ambient temperature after a 5 minute warmup.

<u>Description</u>	<u>Value</u>
<b>Site Master:</b>	Frequency Range:
SM5559	5 to 1600 MHz
Frequency Accuracy (CW):	75 parts per million @ 25°C*
Frequency Resolution:	10 kHz
SWR:	
Range	1.00 to 65.00
Resolution	0.01
Return Loss:	
Range	0.00 to 54.00 dB
Resolution	0.01 dB
**Distance-To-Fault (DTF):	
Range (in meters)	0 to (Resolution x dp)
Resolution (in meters)	$(1.5 \times 10^8) \left( \frac{\Delta F}{V_f} \right)$
(Rectangular Windowing)	
	Where $V_f$ is the relative propagation velocity of the cable .
	dp is the number of data points (128, 256, 512).
	$\Delta F$ is F2 - F1 (in Hz)
Wattmeter Power Monitor:	
Range	-80.0 to +80 dBm or 10.0 pW to 100.0 kW
Offset Range	0 to +60.0 dB
Resolution	0.1 dB or 0.1 xW
RF Detector Range	-50 dBm to + 20 dBm 10.0 $\mu$ W to +100.0 mW
Test Port, Type N	50 Ohms
***Immunity to Interfering signals up to the level of:	+10 dBm, RF Out/Reflection
Maximum Input (Damage Level):	
Test Port, Type N	+22 dBm
RF Detector	+20 dBm
Measurement Accuracy:	
Measurement accuracy depends on calibration components. Precision calibration components have a directivity of 42 dB.	
Cable Insertion Loss:	
Range	0.00 to 54.00 dB
Resolution	0.01 dB
General	
Internal Memory:	
Trace Memory	200 maximum
Instrument config.	10 setup locations
RS-232 Interface:	9 pin D-sub, three wire serial
Electromagnetic Compatibility	Meets European community requirements for CE marking

Table 1-2. Performance Specifications (2 of 2)

---

Power Supply:	
External DC Input	+12.5 to +15 Vdc, 1100 mA max.
Temperature:	
Storage	-20° C to 75° C
Operation	0° C to 50° C
Weight:	1.82 kg (4.0 pounds)
Dimensions:	25.4 x 17.8 x 6.1 cm (10 x 7 x 2.4 inches)

\*  $\pm 2$  ppm/ $\Delta$ C from 25°C

\*\* Fault location is accomplished by inverse Fourier Transformation of data taken with the Site Master. Resolution and maximum range depend on the number of frequency data points, frequency sweep range and relative propagation velocity of the cable being tested.

\*\*\* Immunity measurement is made in CW mode with incoming interfering signal exactly at the same frequency (worst case situation). Typical immunity is better when swept frequency is used.

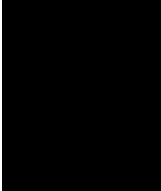

## Preventive Maintenance

Site Master preventive maintenance consists of cleaning the unit and inspecting and cleaning the RF connectors on the instrument and all accessories.

Clean the Site Master with a soft, lint-free cloth dampened with water or water and a mild cleaning solution.

**CAUTION:** *To avoid damaging the display or case, do not use solvents or abrasive cleaners.*

Clean the RF connectors and center pins with a cotton swab dampened with denatured alcohol. Visually inspect the connectors. The fingers of the N (f) connectors and the pins of the N (m) connectors should be unbroken and uniform in appearance. If you are unsure whether the connectors are good, gauge the connectors to confirm that the dimensions are correct.

Visually inspect the test port cable(s). The test port cable should be uniform in appearance, not stretched, kinked, dented, or broken.

## Calibration

The Site Master is a field portable unit operating in the rigors of the test environment. An Open-Short-Load (OSL) calibration should be performed prior to making a measurement in the field. A built-in temperature sensor in the Site Master advises the user, via an icon located on the right side of the LCD screen, that the internal temperature has exceeded a safety window, and the user is advised to perform another OSL calibration in order to maintain the integrity of the measurement.

**NOTES:**

*For best calibration results—compensation for all measurement uncertainties—ensure that the Open/ Short/Load is at the end of the test port or optional extension cable; that is, at the same point that you will connect the antenna or device to be tested.*

*For best results, use a phase stable Test Port Extension Cable (see Optional Accessories). If you use a typical laboratory cable to extend the Site Master test port to the device under test, cable bending subsequent to the OSL calibration will cause uncompensated phase reflections inside the cable. Thus, cables which are NOT phase stable may cause measurement errors that are more pronounced as the test frequency increases.*

*For optimum calibration, Anritsu recommends using precision calibration components.*

## Annual Verification

Anritsu recommends an annual calibration and performance verification of the Site Master and the OSL calibration components by local Anritsu service centers. Anritsu service centers are listed in Table 1-2 on the following page.

The Site Master itself is self-calibrating, meaning that there are no field-adjustable components. However, the OSL calibration components are crucial to the integrity of the calibration and therefore, must be verified periodically to ensure performance conformity. This is especially important if the OSL calibration components have been accidentally dropped or over-torqued.

## Chapter 1 General Information

Table 1-2. Anritsu Service Centers

### UNITED STATES

ANRITSU COMPANY  
685 Jarvis Drive  
Morgan Hill, CA 95037-2809  
Telephone: (408) 776-8300,  
1-800-ANRITSU  
FAX: 408-776-1744

ANRITSU COMPANY  
10 New Maple Ave., Unit 305  
Pine Brook, NJ 07058  
Telephone: (201) 227-8999,  
1-800-ANRITSU  
FAX: 201-575-0092

ANRITSU COMPANY  
1155 E. Collins Blvd  
Richardson, TX 75081  
Telephone: 1-800-ANRITSU  
FAX: 972-671-1877

### AUSTRALIA

ANRITSU PTY. LTD.  
Unit 3, 170 Foster Road  
Mt. Waverley, VIC 3149  
Australia  
Telephone: 03-9558-8177  
Fax: 03-9558-8255

### BRAZIL

ANRITSU ELECTRONICA LTDA.  
Praia de Botafogo 440, Sala 2401  
CEP 22250-040, Rio de Janeiro, RJ,  
Brasil  
Telephone: 021-28-69-141  
Fax: 021-53-71-456

### CANADA

ANRITSU INSTRUMENTS LTD.  
215 Stafford Road, Unit 102  
Nepean, Ontario K2H 9C1  
Telephone: (613) 828-4090  
FAX: (613) 828-5400

### CHINA

ANRITSU BEIJING SERVICE CENTER  
Beijing Fortune Building  
416W, 5 Dong San Huan Bei Lu  
Chaoyang qu  
Beijing 100004, China  
Telephone: 011065909237  
FAX: 011065909236

### FRANCE

ANRITSU S.A  
9 Avenue du Quebec  
Zone de Courtaboeuf  
91951 Les Ulis Cedex  
Telephone: 016-44-66-546  
FAX: 016-44-61-065

### GERMANY

ANRITSU GmbH  
Grafenberger Allee 54-56  
D-40237 Dusseldorf, Germany  
Telephone: 0211-96 85 50  
FAX: 0211-96 85 555

### INDIA

MEERA AGENCIES (P) LTD  
A-23 Hauz Khas  
New Delhi 110 016  
Telephone: 011-685-3959  
FAX: 011-686-6720

### ISRAEL

TECH-CENT, LTD  
Haarad St. No. 7, Ramat Haahayal  
Tel-Aviv 69701  
Telephone: (03) 64-78-563  
FAX: (03) 64-78-334

### ITALY

ANRITSU Sp.A  
Rome Office  
Via E. Vittorini, 129  
00144 Roma EUR  
Telephone: (06) 50-22-666  
FAX: (06) 50-22-4252

### JAPAN

ANRITSU CORPORATION  
1800 Onna Atsugi-shi  
Kanagawa-Prf. 243 Japan  
Telephone: 0462-23-1111  
FAX: 0462-25-8379

### KOREA

ANRITSU CORPORATION LTD.  
#901 Daero Bldg. 26-5  
Yeoido Dong, Youngdeungpo  
Seoul Korea 150 010  
Telephone: 02-782-7156  
FAX: 02-782-4590

### SINGAPORE

ANRITSU (SINGAPORE) PTE LTD  
3 Shenton Way #24-03  
Shenton House  
Singapore 0106  
Telephone: 022-65-206  
FAX: 022-65-207

### SOUTH AFRICA

ETESCSA  
12 Surrey Square Office Park  
330 Surrey Avenue  
Ferndale, Randburt, 2194  
South Africa  
Telephone: 01-11-787-7200  
Fax: 01-11-787-0446

### SWEDEN

ANRITSU AB  
Botvid Center  
S-1585  
Stockholm, Sweden  
Telephone: (08) 534-717-00  
FAX: (08) 534-717-30

### TAIWAN

ANRITSU CO., LTD.  
8F, No. 96, Section 3  
Chien Kuo N. Road  
Taipei, Taiwan, R.O.C.  
Telephone: (02) 515-6050  
FAX: (02) 509-5519

### UNITED KINGDOM

ANRITSU LTD.  
200 Capability Green  
Luton, Bedfordshire  
LU1 3LU, England  
Telephone: 015-82-41-88-53  
FAX: 015-82-31-303



# Chapter 2

## Getting Started

### Introduction

The Nickel Metal Hydride (NiMH) Battery supplied with the Site Master is shipped in a discharged state. Before using the Site Master, the internal battery must first be charged for three hours, either in the Site Master or in the optional battery charger (Anritsu part number: 2000-1029).

### Charging a New Battery

New batteries normally require three to five charge and discharge cycles before attaining maximum performance. The NiMH battery supplied with the Site Master has already completed three charge and discharge cycles at the factory and full battery performance should be realized after your first charge.



### Charging the Battery in the Site Master

The battery can be charged while still installed in the Site Master.

- Step 1.** Turn the Site Master off.
- Step 2.** Connect the AC-DC adapter (Anritsu part number: 40-115) to the Site Master charging port.
- Step 3.** Connect the AC adapter to a 120 VAC or 240 VAC power source as appropriate for your application.

The green external power indicator on the Site Master will illuminate, indicating the presence of external DC power and the battery will begin charging. The indicator will remain lit as long as the battery is charging. Once the battery is fully charged, the battery indicator will turn off. If the battery fails to charge, contact your nearest Anritsu service center.

### Charging the Battery in the Optional Charger

Up to two batteries can be charged simultaneously in the optional battery charger.

- Step 1.** Remove the NiMH battery from your Site Master and place it in the optional charger (Anritsu part number: 2000-1029).
- Step 2.** Connect the lead from the AC-DC adapter to the charger.
- Step 3.** Connect the AC-DC adapter to a 120 VAC or 240 VAC power source as appropriate for your application.

Each battery holder in the optional charger has an LED charging status indicator. The LED color changes as the battery is charged:

- Red indicates the battery is charging
- Green indicates the battery is fully charged
- Yellow indicates the battery is in a waiting state (see below).

A yellow light may occur because the battery became too warm during the charge cycle. The charger will allow the battery to cool off before continuing the charge. A yellow light may also indicate that the charger is alternating charge to each of the two batteries.

A blinking red light indicates less than 13 VDC is being supplied to the charger stand. Check that the correct AC charger adapter is connected to the charger stand.

If a battery fails to charge, contact your nearest Anritsu Service Center.

You can charge the battery anytime. However, NiMH battery will last longer and perform better if allowed to completely discharge before recharging. For maximum battery life, it is recommended that the NiMH battery be completely discharged and recharged once every three months.

## Battery Charge Indicator

When the AC-DC adapter is unplugged from the Site Master, the battery indicator symbol will be continuously displayed at the top left corner of the Site Master display (Figure 2-1).

### Battery Indicator

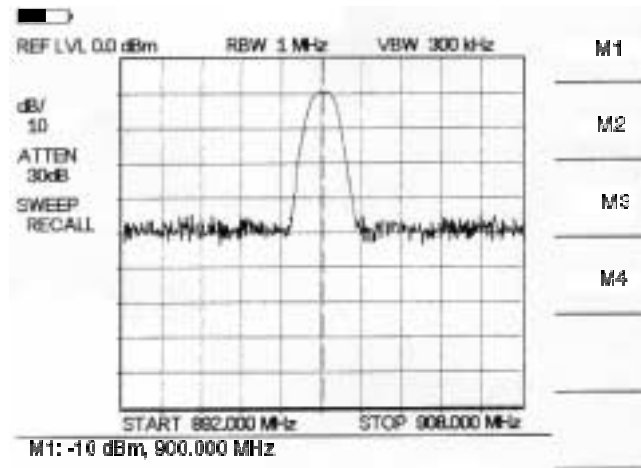

Figure 2-1. Site Master Battery Indicator

A totally black bar indicates a fully charged battery. When LOW BATT replaces the battery indicator bar at the top left corner, a couple of minutes of measurement time remains. If a flashing LOW BATT is accompanied by an audio beep at the end of each trace, the battery has approximately one minute of useable time remaining.

The battery status can also be checked by pressing the **SYS** key and the **STATUS** soft key. The Status table will display the remaining battery charge as a percent, as shown below.

STATUS
OSL CALIBRATION FREQUENCY = 2.0 – 1000 MHz CAL TEMPERATURE (24–54° C)
CURRENT TEMPERATURE = 38° C BATTERY CHARGE = 75%
PRESS ESCAPE TO CONTINUE

Figure 2-2. Example Status Table Display

Once all the power has drained from the battery, the Site Master display will fade. At this point, your Site Master will switch itself off and the battery will need to be recharged.

## Discharging the NiMH Battery

The NiMH battery will last longer and perform better if allowed to completely discharge before recharging. For maximum battery life, it is recommended that the NiMH battery be completely discharged and recharged once every three months.

To discharge the battery, leave the Site Master switched on until the battery is drained. The Site Master will display a LOW BATT message and an audio warning when the battery begins to run low. Allow the battery to fully discharge until the Site Master switches itself off.

**NOTE:**

*Do not attempt to discharge the battery by any other means. Never short-circuit the battery terminals.*

## Battery Life

It is normal for NiMH batteries to self-discharge during storage. To minimize battery discharge during storage, it is recommended that the battery be removed from the Site Master if the Site Master is not to be used for a long period of time.

It is normal for NiMH battery to degrade to 80% of original capacity after 12 months of continuous use.

The battery can be charged and discharged 300 to 500 times, but it will eventually wear out. The battery may need to be replaced when the operating time between charging is noticeably shorter than normal.

## **Important Battery Information**

- With a new NiMH battery, full performance is achieved after three to five complete charge and discharge cycles.
- Use only Anritsu approved battery packs.
- Recharge the battery only in the Site Master or in an Anritsu approved charger.
- When the Site Master or the charger is not in use, disconnect it from the power source.
- Do not charge batteries for longer than 24 hours; overcharging may shorten battery life.
- If left unused a fully charged battery will discharge itself over time.
- Discharge an NiMH battery from time to time to improve battery performance and battery life.
- The battery can be charged and discharged hundreds of times, but it will eventually wear out.
- The battery may need to be replaced when the operating time between charging is noticeably shorter than normal.
- Do not short-circuit the battery terminals.
- Do not drop, mutilate or attempt to disassemble the battery.
- Never use a damaged or worn out charger or battery.
- Always use the battery for its intended purpose only.
- Temperature extremes will affect the ability of the battery to charge: allow the battery to cool down or warm up as necessary before use or charging.
- Storing the battery in extreme hot or cold places will reduce the capacity and lifetime of the battery.
- Do not dispose of batteries in a fire!
- Batteries must be recycled or disposed of properly. Do not place batteries in garbage.

# Chapter 3

## Functions and Operations

### Introduction

This chapter provides a brief overview of the Site Master functions and operations, providing the user with a starting point for making basic measurements. For more detailed information, refer to Chapter 4, *Measurements* and Chapter 5, *Software Tools*.

The Site Master is designed specifically for field environments and applications requiring mobility. As such, it is a lightweight, handheld, battery operated unit which can be easily carried to any location, and is capable of up to 2.5 hours of continuous operation from a fully charged battery. Built-in energy conservation features allow battery life to be extended over an eight-hour workday. The Site Master can also be powered by a 12.5 Vdc external source. The external source can be either the Anritsu AC-DC Adapter (P/N 40-115) or 12.5 Vdc Automotive Cigarette Lighter Adapter (P/N 806-62). Both items are standard accessories.



### Front Panel Overview

The Site Master menu-driven user interface is easy to use and requires little training. Mode, Frequency, Amplitude and Sweep function keys are located just below the display and are easily configured for optimum measurements. Selection of one of these keys brings up a function-specific menu on the right hand side of the display. The softkeys adjacent to the display provide access to the various menu items (See Figure 3-1).

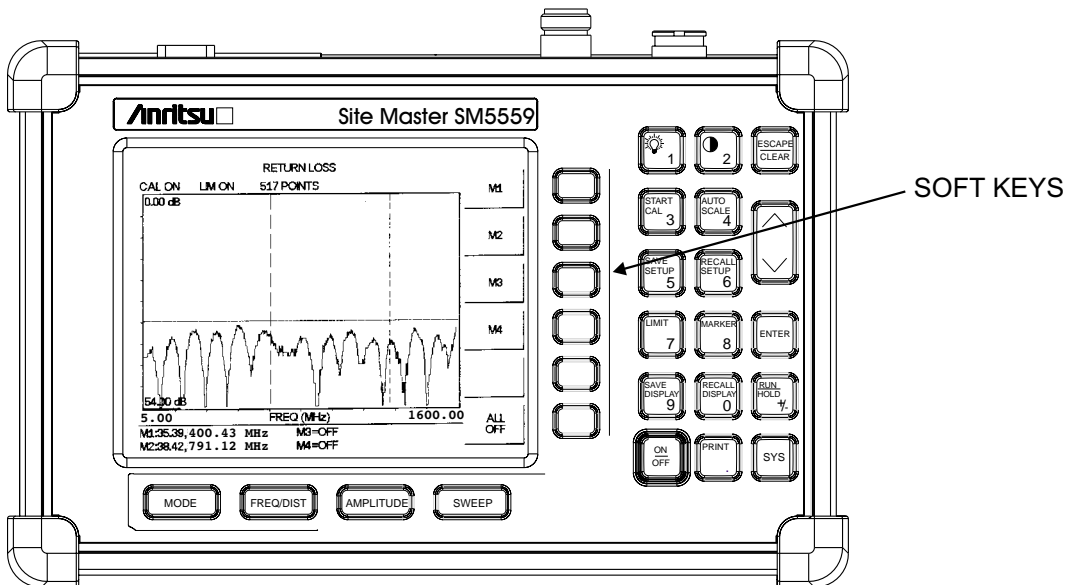

Figure 3-1. Site Master Soft Keys

## Test Connector Panel

The connectors and indicators located on the test panel are listed and described below.

**12.5-15VDC (1100 mA)** 12.5 to 15 Vdc @ 1100 mA input to power the unit or for battery charging.

**WARNING**

*When using the AC-DC Adapter, always use a three-wire power cable connected to a three-wire power line outlet. If power is supplied without grounding the equipment in this manner, there is a risk of receiving a severe or fatal electric shock.*

**Battery Charging** Illuminates when the battery is being charged. The indicator automatically shuts off when the battery is fully charged.

**External Power** Illuminates when the Site Master is being powered by the external charging unit.

**Serial Interface** RS232 DB9 interface to a COM port on a personal computer (for use with the Anritsu Software Tools program) or to a supported printer.

**RF Out** RF output, 50  $\Omega$  impedance, for reflection measurements.

**RF Detector** RF detector input for the Power Monitor.

## Keypad Controls

This section contains an alphabetical listing of the Site Master front panel keypad controls along with a brief description of each. More detailed descriptions of the major function keys follow.



Turns the liquid crystal display (LCD) back-lighting ON or OFF. (Leaving back lighting off conserves battery power.)



LCD Contrast adjust. Use the Up/Down arrow key and **ENTER** to adjust the display contrast.

**AMPLITUDE** Displays the amplitude or scale menu of the current operating mode.

*NOTE:  
The **AMPLITUDE** and **LIMIT** keys are functionally identical.*

**AUTO SCALE** Automatically scales the display for optimum resolution.

**ENTER** Implements certain menu and key selections.

**ESCAPE CLEAR** Exits the present operation or clears the display. If a parameter is being edited, pressing this key will clear the value currently being entered and restore the last valid entry. Pressing this key again will close the parameter. During normal sweeping, pressing this key will move up one menu level.

**FREQ/DIST** Displays the Frequency or Distance menu depending on the measurement mode.

**LIMIT** Displays the amplitude or scale menu of the current operating mode.

**MARKER** Displays the marker menu of the current operating mode.

**MODE** Opens the mode selection box (below). Use the Up/Down arrow key to select a mode. Press the **ENTER** key to implement.

MEASUREMENT MODE	
FREQ -	SWR
RETURN LOSS	
	CABLE LOSS - ONE PORT
DTF -	SWR
	RETURN LOSS
	POWER MONITOR

Figure 3-2. Mode Selection Box

**ON  
OFF** Turns the Site Master on or off. When turned on, the system state at the last turn-off is restored. If the **ESCAPE/CLEAR** key is held down, the factory preset state is restored.

**PRINT** Prints the current display to the selected printer via the RS232 serial port.

**RECALL  
DISPLAY** Recalls a previously saved trace from memory. When the key is pressed, a Recall Trace selection box appears on the display. Select a trace using the Up/Down arrow key and press the **ENTER** key to implement.

To erase a saved trace, highlight the trace and select the **DELETE TRACE** softkey. To erase all saved traces, select the **DELETE ALL TRACES** softkey.

**RECALL  
SETUP** Recalls a previously saved setup from memory location 1 through 10. When the key is pressed, a **RECALL SETUP** selection box appears on the display. Select a setup using the Up/Down arrow key and press the **ENTER** key to implement. Setup 0 recalls the factory preset state.

**RUN  
HOLD** When in the Hold mode, this key starts the Site Master sweeping and provides a Single Sweep Mode trigger; when in the Run mode, it pauses the sweep. When in the Hold mode, the hold symbol (page 3-22) appears on the LCD. Hold mode conserves battery power.

**SAVE  
DISPLAY** Saves up to 200 displayed traces to non-volatile memory. When the key is pressed, **TRACE NAME:** appears in the lower left of the display. Save the display with up to 16 alphanumeric characters for that trace name and press the **ENTER** key to implement.

**SAVE  
SETUP** Saves the current system setup to 1 of 10 internal non-volatile memory locations. When the key is pressed, a **SAVE SETUP** selection box appears on the display. Use the Up/Down arrow key to select a setup and press the **ENTER** key to implement.

**START  
CAL** Starts the calibration in SWR, Return Loss, Cable Loss, or DTF measurement modes. Follow the text in the lower left message area that instructs you to do the following:

- CONNECT OPEN TO RF out PORT, Press ENTER**  
The Site Master then measures the calibration “open” that you must attach to the end of the test port or transmission line.
- CONNECT SHORT TO RF out PORT, Press ENTER**  
The Site Master then measures the calibration “short” that you must attach to the end of the test port or transmission line.
- CONNECT LOAD TO RF out PORT, Press ENTER**  
The Site Master then measures the 50Ω load that you must attach to the end of the test port or transmission line.

**NOTE:**

*The combined measurements of an open, a short, and a known-impedance load normalizes the measurement system to account for uncertainties introduced by measurement-system components (e.g., cables, connectors, etc.).*



<b>SWEEP</b>	Displays the Sweep function soft key menu for the current operating mode.
<b>SYS</b>	Displays the System menu softkey selections.
<b>Up/Down Arrow Key</b>	Increments or decrements a parameter value or chooses an item from a list which can then be selected with the <b>ENTER</b> key.

*NOTE:*  
*At turn on, before any other keys are pressed, the Up/Down arrow key may be used to adjust display contrast.*

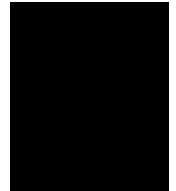

## Soft Keys

Each keypad key opens a set of soft key selections. Each of the soft keys has a corresponding soft key label area on the display. The label identifies the function of the soft key for the current Mode selection.

**NOTE:**  
The *AMPLITUDE* and *LIMIT* keys are functionally identical.

Figures 3-3 through 3-6 show the soft key labels for each Mode selection.

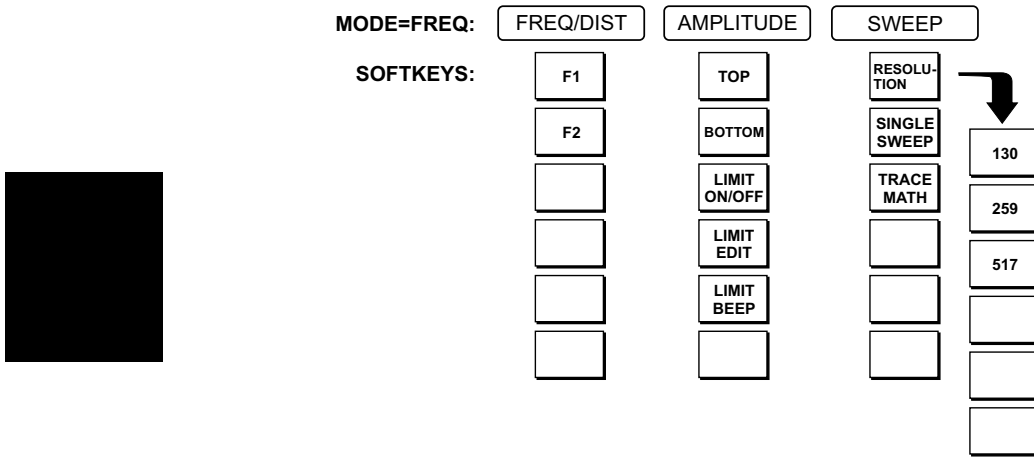

Figure 3-3. Frequency Mode Soft Key Labels

### MODE=POWER MONITOR:

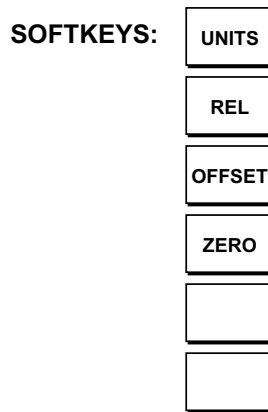

Figure 3-4. Power Monitor Mode Soft Key Labels

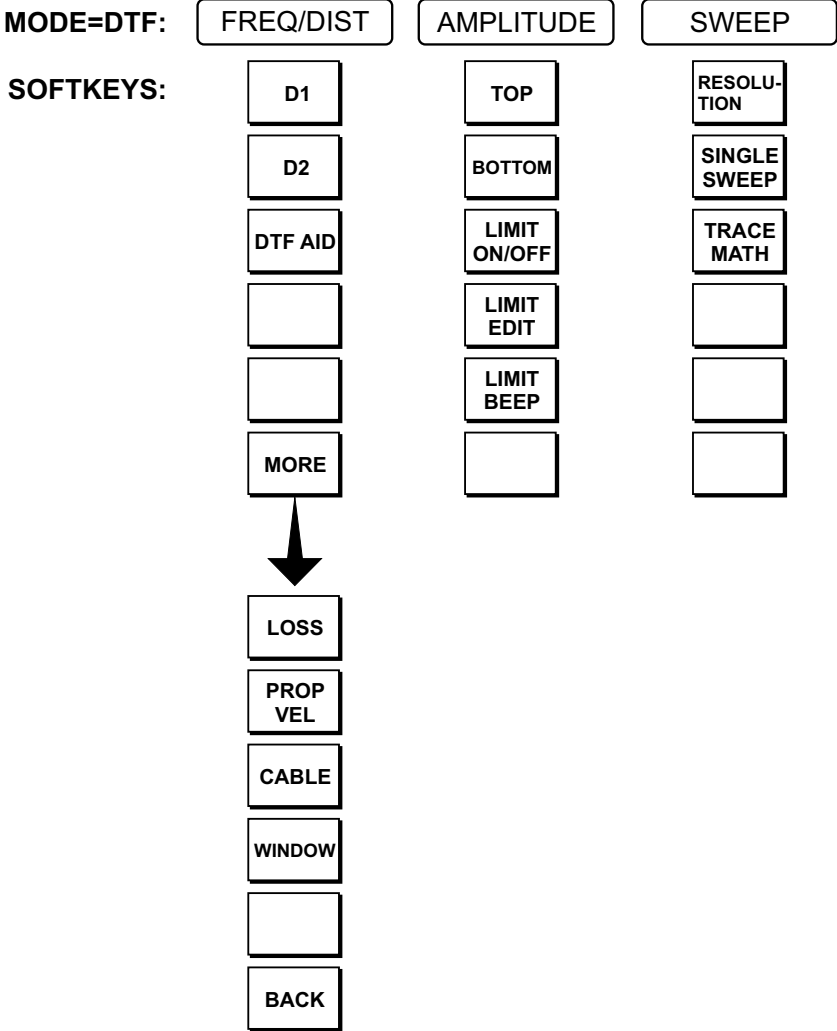

Figure 3-5. Distance to Fault Mode Soft Key Labels

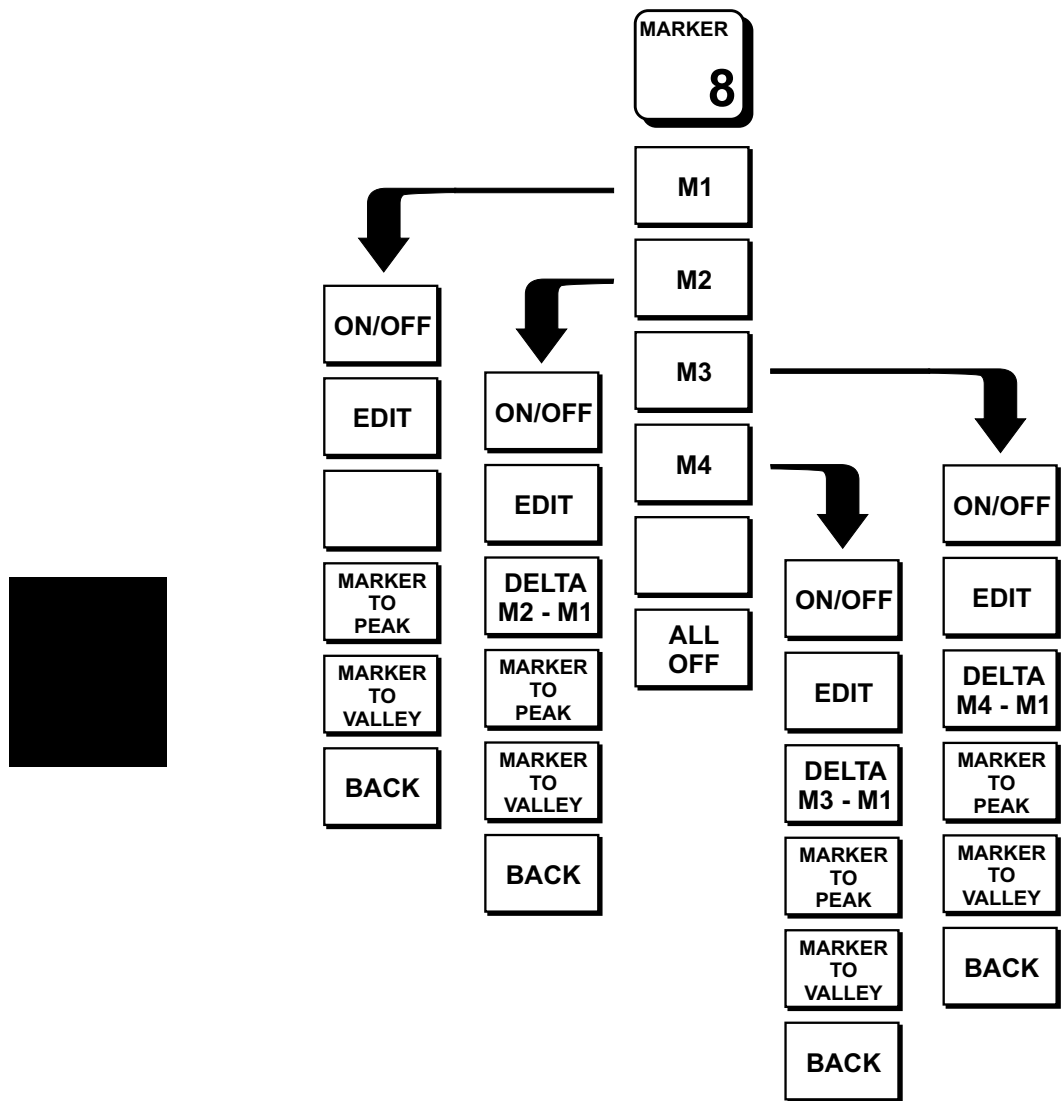

Figure 3-6. Marker Key Soft Key Labels

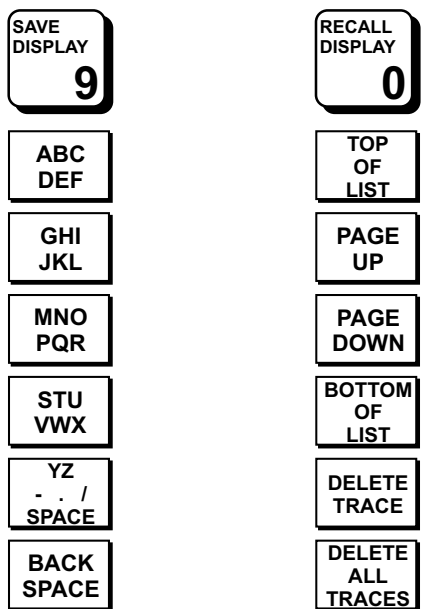

Figure 3-7. Save Display and Recall Display Soft Key Menus

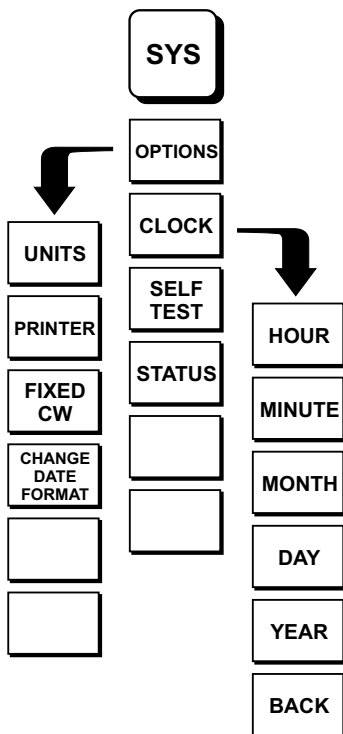

Figure 3-8. SYS Key Soft Key Menus

**FREQ/DIST** Displays the frequency or distance menu depending on the measurement mode.

**Frequency Menu** Provides for setting sweep frequency end points when **FREQ** mode is selected. Selected frequency values may be changed using the keypad or Up/Down arrow key.

- **F1** — Opens the F1 parameter for data entry. This is the start value for the frequency sweep. Press **ENTER** when data entry is complete.
- **F2** — Opens the F2 parameter for data entry. This is the stop value for the frequency sweep. Press **ENTER** when data entry is complete.

**Distance Menu** Provides for setting Distance to Fault parameters when a DTF mode is selected. Choosing **DIST** causes the soft keys, below, to be displayed and the corresponding values to be shown in the message area. Selected distance values may be changed using the keypad or Up/Down arrow key.

- **D1** — Opens the start distance (D1) parameter for data entry. This is the start value for the distance range. Press **ENTER** when data entry is complete.
- **D2** — Opens the end distance (D2) parameter for data entry. This is the end value for the distance range. Press **ENTER** when data entry is complete.
- **DTF AID** — Provides interactive help to optimize DTF set up parameters. You will be prompted for system parameter values of maximum distance, frequency span, and propagation velocity.
- **MORE** — Selects the Distance Sub-Menu, detailed below.

**Distance Sub-Menu** Provides for setting the cable loss and relative propagation velocity of the coaxial cable. Selected values may be changed using the Up/Down arrow key or keypad.

- **LOSS** — Opens the Cable Loss parameter for data entry. Enter the loss per foot (or meter) for the type of transmission line being tested. Press **ENTER** when data entry is complete. (Range is 0.000 to 5.000 dB/m)
- **PROP VEL** (relative propagation velocity) — Opens the Propagation Velocity parameter for data entry. Enter the propagation velocity for the type of transmission line being tested. Press **ENTER** when data entry is complete. (Range is 0.010 to 1.000)
- **CABLE** — Opens a common coaxial cable folder and custom coaxial cable folder. Select either folder and use the Up/Down arrow key and **ENTER** key to make a selection. This feature provides a rapid means of setting both cable loss and propagation velocity. (Refer to Appendix A for a listing of common coaxial cables showing values for “Relative Propagation Velocity” and “Nominal Attenuation in dB/m @ 1000 MHz”.) The custom cable folder consists of up to 49 user-defined cable parameters downloaded via the Site Master Software Tools program.
- **WINDOW** — Opens a menu of FFT windowing types for the DTF calculation. Scroll the menu using the Up/Down arrow key and make a selection with the **ENTER** key.

*NOTE: Using windowing:*

*The theoretical requirement for inverse FFT is for the data to extend from zero frequency to infinity. Side lobes appear around a discontinuity due to the fact that the spectrum is cut off at a finite frequency. Windowing reduces the side lobes by smoothing out the sharp transitions at the beginning and end of the frequency sweep. As the side lobes are reduced the main lobe widens thereby reducing the resolution.*

*In situations where there may be a small discontinuity close to a large one, side lobe reduction Windowing should be used. When distance resolution is critical Windowing can be reduced. The types of Windowing in order of increasing side lobe reduction are: rectangular, nominal side lobe, low side lobe, minimum side lobe. Figures 3-9 thru 3-12, on pages 3-12 and 3-13, are examples of the types of Windowing.*

□ **BACK** — Returns to the Distance Menu.

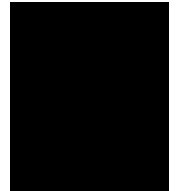

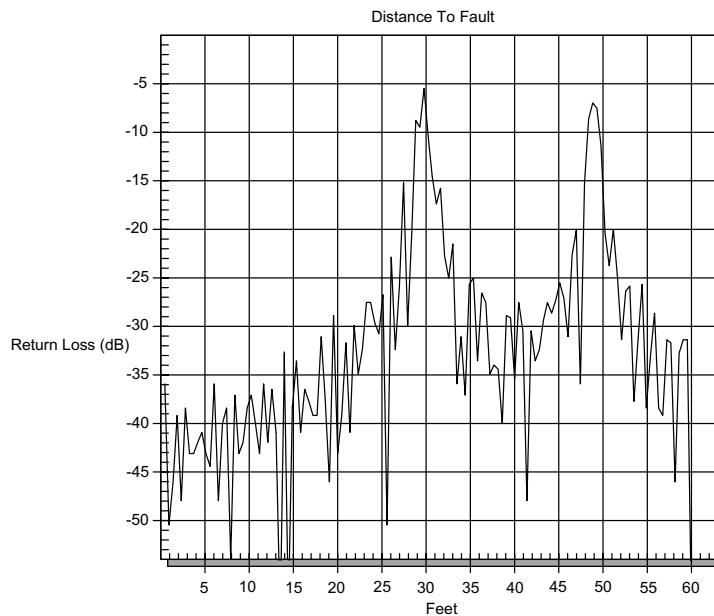

Figure 3-9. Rectangular Windowing Example

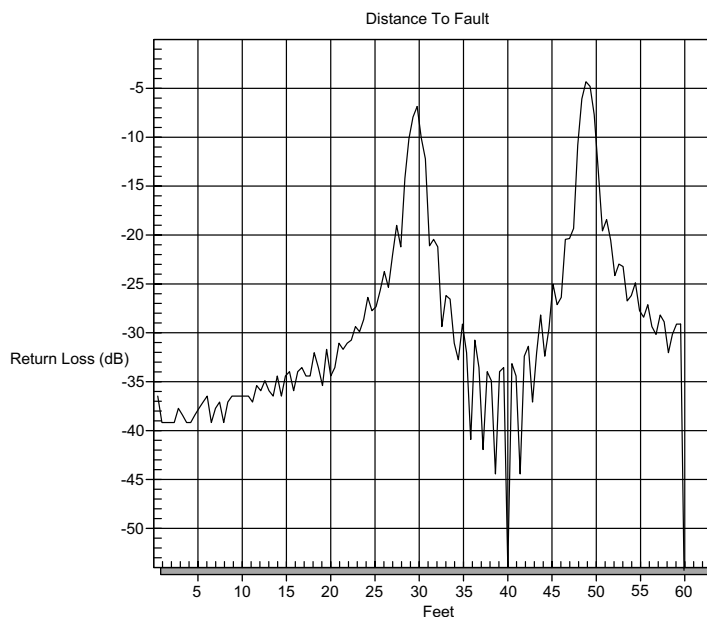

Figure 3-10. Nominal Side Lobe Windowing Example



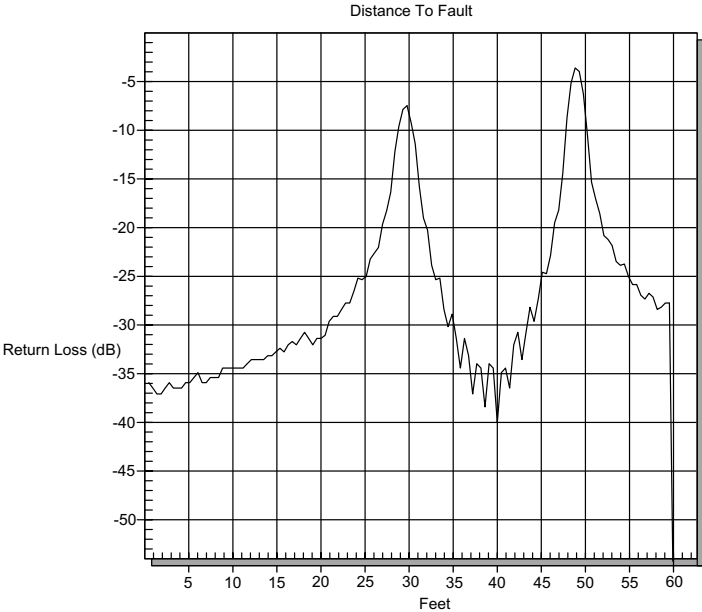

Figure 3-11. Low Side Lobe Windowing Example

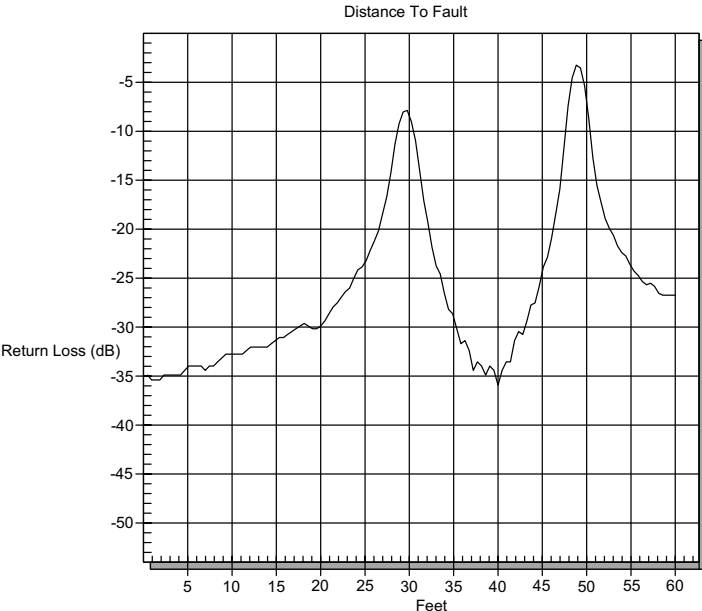

Figure 3-12. Minimum Side Lobe Windowing Example

**AMPLITUDE** Displays the amplitude or scale menu depending on the measurement mode.

**Amplitude Menu** Provides for changing the display scale. Selected values may be changed using the Up/Down arrow key or keypad.

Choosing **AMPLITUDE** in **FREQ** or **DTF** measurement modes causes the soft keys, below, to be displayed and the corresponding values to be shown in the message area.

Pressing the **LIMIT** key on the keypad will also call up this menu.

- ❑ **TOP** — Opens the top parameter for data entry and provides for setting the top scale value. Press **ENTER** when data entry is complete.
- ❑ **BOTTOM** — Opens the bottom parameter for data entry and provides for setting the bottom scale value. Press **ENTER** when data entry is complete.
- ❑ **LIMIT ON/OFF** — Turns Limit OFF, if currently ON. If Limit is currently OFF, turns it ON and opens the Limit parameter for data entry. Press **ENTER** when data entry is complete.
- ❑ **LIMIT EDIT** — Opens the Limit Line for data entry using the Up/Down arrow key or key pad entry. Press **ENTER** when data entry is complete.
- ❑ **LIMIT BEEP** — Toggles the Limit beep sound on or off. When on, the Site Master sounds a beep when the measured value is above the Limit Line.



**SWEEP** Displays the Sweep function soft key menu for the current operating mode.

**Sweep Menu** Provides for changing the display resolution, single or continuous sweep, and access to the Trace Math functions.

Choosing **SWEEP** in **FREQ** or **DTF** measurement modes causes the soft keys below to be displayed.

- RESOLUTION** — Opens the display to change the resolution. Choose 130, 259, or 517 data points. (Not active in DTF mode. In DTF mode, resolution can be adjusted through the DTF-AID table.)
- SINGLE SWEEP** — Toggles the sweep between single sweep and continuous sweep. In single sweep mode, each sweep must be activated by the **RUN/HOLD** button.
- TRACE MATH** — Opens up the Trace Math functions (trace-memory or trace+memory) for comparison of the real time trace in the display with any of the traces from memory. (Not available in DTF mode.)



**MARKER**

Choosing **MARKER** causes the soft keys, below, to be displayed and the corresponding values to be shown in the message area. Selected frequency marker or distance marker values may be changed using the keypad or Up/Down arrow key.

- M1** — Selects the M1 marker parameter and opens the Markers second level menu.
- M2** — Selects the M2 marker parameter and opens the Markers second level menu.
- M3** — Selects the M3 marker parameter and opens the Markers second level menu.
- M4** — Selects the M4 marker parameter and opens the Markers second level menu.
- ALL OFF** — Turns all markers off.

**Markers  
(second level)**

Provides for turning the selected marker on and off and for setting marker values. Selected frequency marker and distance marker values can be changed using the keypad or Up/Down arrow key.

Choosing **M1**, **M2**, **M3**, or **M4** in **FREQ** or **DTF** measurement modes causes the soft keys, below, to be displayed and the corresponding values to be shown in the message area.

- ON/OFF** — Turns the selected marker on or off.
- EDIT** — Opens the selected marker parameter for data entry. Press **ENTER** when data entry is complete or **ESCAPE** to restore the previous value.
- DELTA (Mx-M1)** — Displays delta amplitude value for as well as delta frequency or distance for the selected marker with respect to the M1 marker.
- MARKER TO PEAK** — Places the selected marker at the frequency or distance with the maximum amplitude value.
- MARKER TO VALLEY** — Places the selected marker at the frequency or distance with the minimum amplitude value.
- BACK** — Returns to the Main Markers Menu.

- SYS** Displays the System menu softkey selections.
- ❑ **OPTIONS** — Displays a second level of functions.
  - ❑ **CLOCK** — Displays a second level of functions.
  - ❑ **SELF TEST** — Start an instrument self test.
  - ❑ **STATUS** — Displays instrument status.
- Options Sub-Menu**
- ❑ **UNITS** — Select the unit of measurement, either English (feet) or metric (meters).
  - ❑ **PRINTER** — Displays a menu of supported printers. Use the Up/Down arrow key and **ENTER** key to make the selection.
  - ❑ **FIXED CW** — Toggles the fixed CW function ON or OFF. When ON, sweep time is reduced and immunity to RF interference is less. When OFF, (normal mode) the unit provides maximum RF interference immunity.
  - ❑ **CHANGE DATE FORMAT** — Toggles the date format between MM/DD/YY, DD/MM/YY, and YY/MM/DD.
- Clock Sub-Menu**
- ❑ **HOUR** — Enter the hour (0-23) using the Up/Down arrow key or the keypad. Press **ENTER** when data entry is complete or **ESCAPE** to restore the previous value.
  - ❑ **MINUTE** — Enter the minute (0-59) using the Up/Down arrow key or the keypad. Press **ENTER** when data entry is complete or **ESCAPE** to restore the previous value.
  - ❑ **MONTH** — Enter the month (1-12) using the Up/Down arrow key or the keypad. Press **ENTER** when data entry is complete or **ESCAPE** to restore the previous value.
  - ❑ **DAY** — Enter the day using the Up/Down arrow key or the keypad. Press **ENTER** when data entry is complete or **ESCAPE** to restore the previous value.
  - ❑ **YEAR** — Enter the year (1997-2036) using the Up/Down arrow key or the keypad. Press **ENTER** when data entry is complete or **ESCAPE** to restore the previous value.
  - ❑ **BACK** — Returns to the top-level SYS menu.
- SAVE DISPLAY** Choosing Save Display activates the alphanumeric menu for trace storage. Use the soft keys to enter a label for the saved trace.
- For example, to save a display with the name “TRACE1” press the soft key for the group that contains the letter “T” and then press the “T” soft key. Press the soft key for the group that contains the letter “R” then press the “R” soft key. Continue for the rest of the letters. Use the number keys on the numeric keypad to enter numbers. Use the softkeys and keypad as necessary to enter the entire name, then press **ENTER** to complete the process.
- The **BACK SPACE** softkey removes the currently highlighted letter in the trace name.

**RECALL  
DISPLAY**

Recalls a trace from memory for viewing or to be used as a trace overlay. Selections are:

- ❑ **TOP OF LIST** — Move the selection cursor to the top (first) memory location.
- ❑ **PAGE UP** — Move the selection cursor to the top of the previous trace memory location page. Each page contains 15 trace memory locations.
- ❑ **PAGE DOWN** — Move the selection cursor to the top of the next trace memory location page.
- ❑ **BOTTOM OF LIST** — Move the selection cursor to the bottom (last) memory location.
- ❑ **DELETE TRACE** — Delete the selected trace from memory. This option is not available when using Trace Overlay.
- ❑ **DELETE ALL TRACES** — Delete all traces from memory.

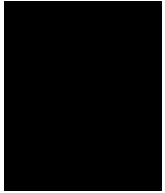

## Power Monitor Menu

Selecting **POWER MONITOR** from the Mode menu causes the soft keys, described below, to be displayed and the corresponding values shown in the message area.

- ❑ **UNITS** — Toggles between dBm and Watts.
- ❑ **REL** — Turns relative mode OFF, if currently ON. If relative mode is currently OFF, turns it ON and causes the power level to be measured and saved as the base level. Subsequent measurements are then displayed relative to this saved value. With units of dBm, relative mode displays dBr; with units of Watts, relative mode displays % (percent).
- ❑ **OFFSET** — Turns Offset OFF, if currently ON. If Offset is currently OFF, turns it ON and opens the Offset parameter for data entry. Press **ENTER** when data entry is complete.  
Offset is the attenuation (in dB) inserted in the line between the DUT and the RF detector. The attenuation is added to the measured input level prior to display.
- ❑ **ZERO** — Turns Zero OFF, if currently ON. If Zero is currently OFF, this softkey turns it ON and initiates collection of a series of power level samples, which are averaged and saved. This saved value is then subtracted from subsequent measurements prior to display.



## Printing

Printing is accomplished by selecting an available printer and pressing the print key as described below. Refer to the particular printer operating manual for specific printer settings.

### Printing a Screen

**Step 1.** Connect the printer as shown in Figure 3-13.

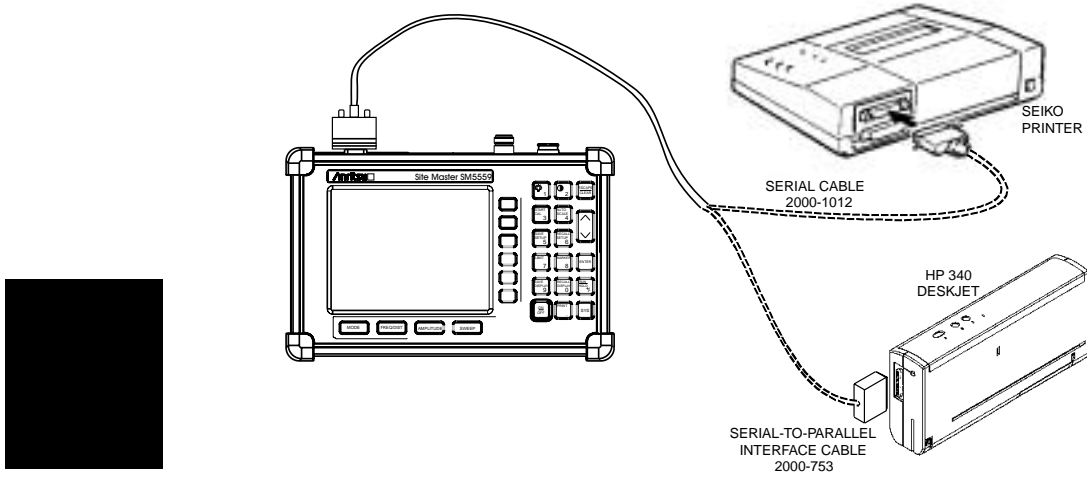

Figure 3-13. Site Master Printer Setup

**Step 2.** Obtain the desired measurement display

**Step 3.** Press the **SYS** key and the **OPTIONS** soft key (Figure 3-14).

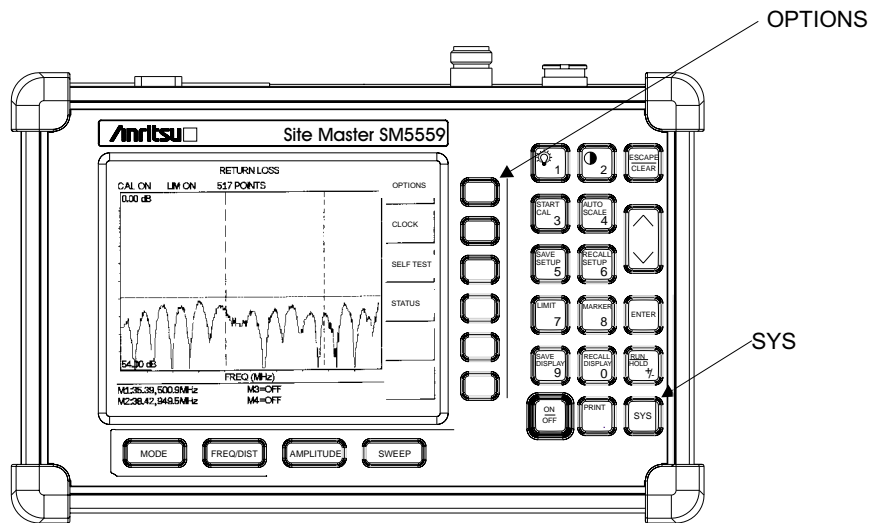

Figure 3-14. SYS Key and OPTIONS Soft Key



- Step 4.** Press the **PRINTER** soft key and select from the displayed menu of supported printers.
- Step 5.** Press the **PRINT** key. (Figure 3-15).

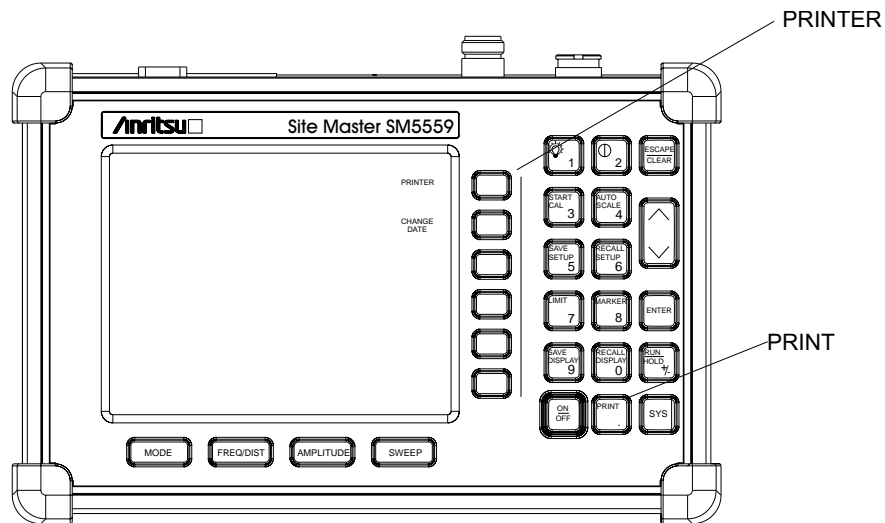

Figure 3-15. PRINTER Soft Key and PRINT Key

### Printer Switch Settings

Set the switches, SW1, SW2, and SW3, on the Seiko DPU-414 thermal printer as follows:

<u>Switch</u>	<u>1</u>	<u>2</u>	<u>3</u>	<u>4</u>	<u>5</u>	<u>6</u>	<u>7</u>	<u>8</u>
SW1	OFF	ON	ON	ON	ON	OFF	ON	ON
SW2	ON	ON	ON	ON	ON	ON	ON	OFF
SW3	ON	ON	ON	OFF	OFF	ON	ON	ON







Set the switches on the serial-to-parallel interface cable to all other printers as follows:

<u>SW1</u>	<u>SW2</u>	<u>SW3</u>	<u>SW4</u>	<u>SW5</u>	<u>SW6</u>	<u>SW7</u>	<u>SW8</u>
OFF	ON	OFF	OFF	OFF	OFF	ON	OFF

## Symbols

Table 3-1 provides a listing of the symbols used as condition indicators on the LCD display.

Table 3-1. LCD Icon Symbols

<u>Icon</u>	<u>Symbol</u>
	Site Master is in Hold for power conservation. To resume sweeping, press the <b>RUN/HOLD</b> key. After 10 minutes without a key press, the Site Master will automatically activate the power conservation mode.
	Integrator Failure
	Lock fail indication. Check battery. (If the Site Master fails to lock with a fully charged battery, call your Anritsu Service Center.)
	When calibration is performed, the Site Master stores the ambient temperature. If the temperature drifts outside the specified range, this indicator will flash. A recalibration at the current temperature is recommended.
	Indicates the remaining charge on the battery. The inner white rectangle grows longer as the battery charge depletes.
	Indicates internal data processing.

## Self Test

At turn-on, the Site Master runs through a series of quick checks to ensure the system is functioning properly. Note that the battery voltage and temperature are displayed in the lower left corner below the self test message. If the battery is low, or if the ambient temperature is not within the specified operational range, Self Test will fail. If Self Test fails and the battery is fully charged and the Site Master is within the specified operating range, call your Anritsu Service Center.

## Error Codes

### Self Test Errors

A listing of Self Test Error messages is given in Table 3-2.

Table 3-2. Self Test Error Messages

<u>Error Message</u>	<u>Description</u>
BATTERY LOW	Battery voltage is less than 9.5 volts. Charge battery. <i>If condition persists, call your Anritsu Service Center.</i>
EXTERNAL POWER LOW	External supply voltage is less than 12.5 volts. <i>Call your Anritsu Service Center</i>
PLL FAILED	Phase-locked loops failed to lock. Charge battery. <i>If condition persists with a fully charged battery, call your Anritsu Service Center</i>
INTEGRATOR FAILED	Integration circuit could not charge to a valid level. Charge battery. <i>If condition persists with a fully charged battery, call your Anritsu Service Center.</i>
EEPROM R/W FAILED	Non-volatile memory system has failed. <i>Call your Anritsu Service Center.</i>
OUT OF TEMP. RANGE	Ambient temperature is not within the specified operating range. <i>If the temperature is within the specified operating range and the condition persists, call your Anritsu Service Center.</i>

*Note: A listing of current Anritsu service centers is given in Table 1-2, page 1-8.*

## Range Errors

A listing of Range Error messages is given in Table 3-3.

Table 3-3. Range Error Messages (1 of 2)

<u>Error Message</u>	<u>Description</u>
RANGE ERROR:F1 > F2	The start (F1) frequency is greater than the stop (F2) frequency.
RANGE ERROR:D1 > D2	The start (D1) distance is greater than the stop (D2) distance.
RANGE ERROR:D2 > DMax=xx.x ft (m)	The stop distance (D2) exceeds the maximum unaliased range. This range is determined by the frequency span, number of points, and relative propagation velocity:  $\text{MaximumUnaliased Range} = \frac{(1.5 \times 10^8) (dp) (V_f)}{F2 - F1} \text{ meters}$ <p>Where: <i>dp</i> is the number of data points (128, 256, or 512)  <i>V<sub>f</sub></i> is the relative propagation velocity  <i>F2</i> is the stop frequency in Hz  <i>F1</i> is the start frequency in Hz</p> Refer to Figure 3-16, page 3-25, for a plot of maximum range versus frequency span.
RANGE ERROR: TOP<=BOTTOM	The SWR scale parameter top value is less than or equal to its bottom value.
RANGE ERROR: TOP>=BOTTOM	The RL scale parameter top value is greater than or equal to its bottom value.
CAL INCOMPLETE	A complete open, short, and load calibration must be performed before calibration can be turned on.
DIST REQUIRES F1 < F2	Valid distance to fault plots require a non-zero frequency span.
DIST REQUIRES CAL	Distance-to-fault measurements do not provide usable data with CAL OFF.
NO STORED SWEEP AT THIS LOCATION	Attempting to recall a display from a location that has not been previously written to. That is, the location does not contain stored sweep.
USE OPTIONS MENU TO SELECT A PRINTER	Attempting to print a display with no printer selected. Select a printer, then retry.
DISTANCE AND CABLE INSERTION LOSS MODE ARE INCOMPATIBLE	DTF measurements only display RL or SWR versus distance.
CANNOT ZERO NO DETECTOR INSTALLED	Attempting to perform a Power Monitor zero adjust function with no RF detector connected to the Site Master.

Table 3-3. Range Error Messages (2 of 2)

<u>Error Message</u>	<u>Description</u>
CANNOT ZERO INPUT SIGNAL TOO HIGH	Attempting to perform a Power Monitor zero adjust function with an input of greater than -20 dBm.
POWER MONITOR OPTION NOT INSTALLED	Attempting to enter Power Monitor mode with no option 5 installed.

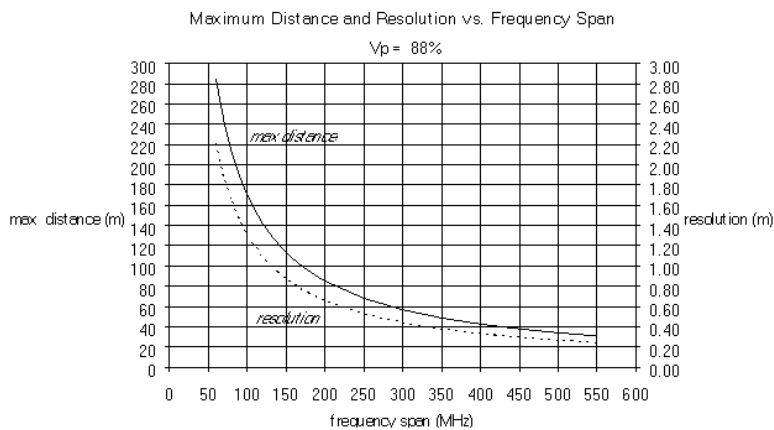
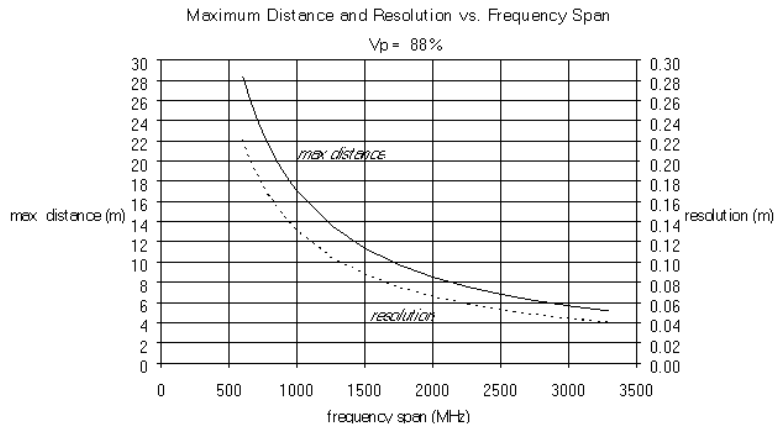
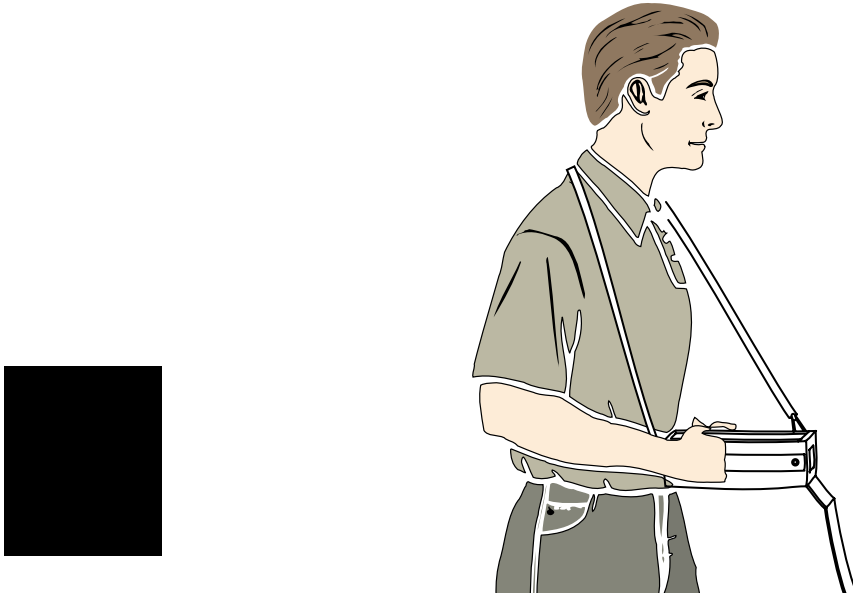

Figure 3-16. Maximum Distance and Resolution vs Frequency Span

## Using the Soft Carrying Case

The soft carrying case has been designed such that the strap can be unsnapped to allow the case to be easily oriented horizontally; thus allowing the Anritsu controls to be more easily accessed (Figure 3-17).

---



---

Figure 3-17. Using the Site Master Soft Carrying Case

# Chapter 4

## Measurements

### Introduction

This chapter provides a description of the Site Master measurement functions and examples of frequency domain, and distance domain measurements.

### Measurement Functions

Site Master operation is divided into three measurement modes: frequency domain, distance domain, and power monitor.

- Frequency domain measurements consist of Return Loss (RL), Standing Wave Ratio (SWR), and Cable Loss (CL) made over a selectable frequency range. SWR and RL characterize the magnitude of reflections present in a device or transmission line. CL measurements display the insertion loss of a transmission line over frequency.
- Distance domain measurements—commonly known as distance-to-fault (DTF)—are made over a selectable distance range. They include RL or SWR, but they also return information that can help locate discontinuities in a transmission line. CL cannot be measured in the distance domain.
- Power monitor measurements can be either absolute or relative to some base power level, and can be displayed in either dBm or Watts. To allow measurement and display of power levels above the unit's specified input, the user may attenuate the signal and enter the corresponding offset. The offset is added to the measured input power prior to display. Finally, a zero adjust function is provided to allow subtraction of an inherent “noise” level prior to display.

4

**CAUTION:** *The measurement system MUST be calibrated at the ambient temperature prior to making a measurement. You must calibrate when the setup frequency is changed. Calibrations are stored with each of the setups.*

Performing open, short, load calibration on the Site Master prior to making measurements can help minimize system uncertainties.

## Power On Procedure

The Site Master is designed specifically for field environments and applications requiring mobility. As such, it is a lightweight, handheld, battery operated unit which can be easily carried to any location, and is capable of up to 2.5 hours of continuous operation from a fully charged battery. Built-in energy conservation features allow battery life to be extended over an eight-hour workday. The Site Master can also be powered by a 12.5 Vdc external source. The external source can be either the Anritsu AC-DC Adapter (P/N 40-115) or 12.5 Vdc Automotive Cigarette Lighter Adapter (P/N 806-62) provided.

**Step 1.** Press the **ON/OFF** key.

The Site Master takes about five seconds to perform a series of self-diagnostic and adjustment routines. At completion, the screen displays the Anritsu logo, the model number, and the version of firmware installed.

**Step 2.** Press **ENTER** to continue, or wait for one minute.

The Site Master is now ready for operation.

## Calibration Procedure

The following procedure provides the steps necessary to perform an Open-Short-Load (OSL) calibration. Calibration is done with the maximum 517 data points and is valid for 130 and 259 data point settings. Refer to Figure 4-1 for setup.

**Step 1.** Press the **MODE** key.

**Step 2.** Use the Up/Down arrow key to scroll to **FREQ - SWR** or **RETURN LOSS**.

**Step 3.** Press the **ENTER** key to select the SWR or Return Loss measurement mode.

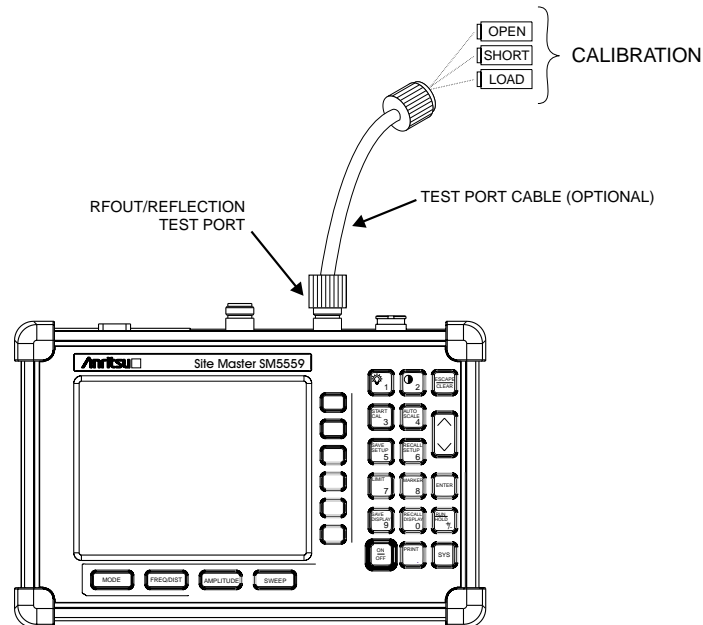

Figure 4-1. Calibration Setup



## Selecting the Frequency Range

The following procedure selects the frequency range for the calibration.

- Step 4.** Press the **FREQ/DIST** key.
- Step 5.** Press the **F1** soft key.
- Step 6.** Enter 5 or a user-defined frequency using the key pad or the Up/Down arrow key.
- Step 7.** Press **ENTER** to set F1 to 5 MHz.
- Step 8.** Press the **F2** soft key.
- Step 9.** Enter 1, 6, 0, 0 or a user-defined frequency using the keypad or the Up/Down arrow key.
- Step 10.** Press **ENTER** to set F2 to 1600 MHz.
- Step 11.** Check that the FREQ (MHz) scale in the display area indicates the new frequency start and stop values (for example: F1 = 5 MHz, F2 = 1600 MHz).

## Performing a Calibration

The following procedure details how to perform the calibration.

- Step 12.** Press the **START CAL** key. The message “Connect Open to RF OUT port” will appear in the display.
- Step 13.** Connect the calibrated Open and press the **ENTER** key. The messages “MEASURING OPEN” and “CONNECT SHORT TO RF OUT” will appear.
- Step 14.** Remove the Open, connect the calibrated Short and press the **ENTER** key. The messages “MEASURING SHORT” and “CONNECT LOAD TO RF OUT” will appear.
- Step 15.** Remove the Short, connect the calibrated Load and press the **ENTER** key. The messages “MEASURING LOAD ” will appear.
- Step 16.** Verify that the calibration has been properly performed by checking that the message “CAL ON” is displayed in the upper left corner of the display.

## Setting the Amplitude Scale

The following procedure details how to set the Amplitude Scale.

- Step 1.** Press the **AMPLITUDE** or **LIMIT** key to call up the Scale menu.
- Step 2.** In SWR mode, press the **TOP** soft key and enter 1, ., 1 using the key pad or the Up/Down arrow key, and press **ENTER**. (In Return Loss mode, enter 0.)
- Step 3.** In SWR mode, press the **BOTTOM** soft key and enter 1 using the key pad or the Up/Down arrow key, and press **ENTER**. (In Return Loss mode, enter 54.)

**NOTE:**

Figure 4-2 and 4-3 show the typical responses of a valid calibration with a load attached to the test port.

To change the number of data points, press the **SWEEP** key, followed by the **RESOLUTION** soft key. Select 130, 259, or 517 data points.

## Saving the Setup

The following procedure saves a setup to memory.

- Step 1.** To save the configuration in one of the 10 available user setup locations, press **SAVE SETUP** and use the key pad or the Up/Down arrow key to select a location (1 - 10), then press **ENTER**.

## Recalling a Setup

The following procedure recalls a setup from memory.

- Step 1.** Press the **RECALL SETUP** key.
- Step 2.** Select the desired setup using the Up/Down arrow key and press **ENTER** to recall the display.

## Saving a Display to Memory

The following procedure saves a display to memory.

- Step 1.** Press the **SAVE DISPLAY** key to activate the alphanumeric menu for trace storage.
- Step 2.** Use the soft keys to enter a label for the saved trace.

For example, to save a display with the name "TX1 RETURN LOSS" press the soft key group that contains the letter "T" then press the "T" soft key. Press the soft key group that contains the letter "X" then press the "X" soft key. Press the number "1" key on the numeric keypad. Use the softkeys and keypad as necessary to enter the entire name, then press **ENTER** to complete the process.

*NOTE: More than one trace can be saved using the same alphanumeric name, as traces are stored chronologically, using the time/date stamp.*

## Recalling a Display From Memory

The following procedure recalls a previously saved display from memory.

- Step 1.** Press the **RECALL DISPLAY** key.
- Step 2.** Select the desired display using the Up/Down arrow key and press **ENTER** to recall the display.

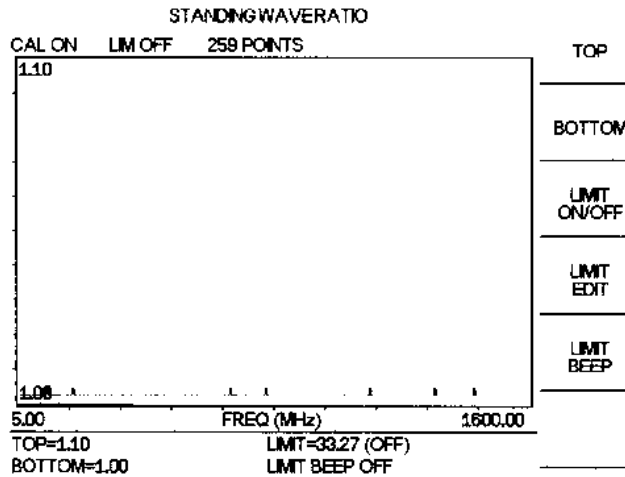

Figure 4-2. SWR Measurement Mode Calibration Results

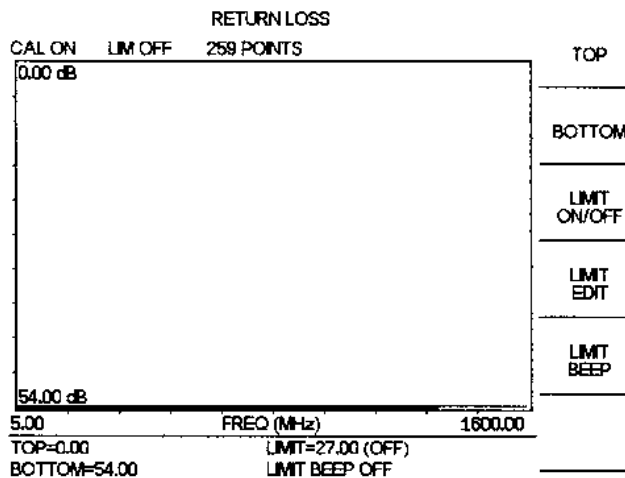

Figure 4-3. Return Loss Measurement Mode Calibration Results

*NOTES: For best calibration results—compensation for all measurement system uncertainties—ensure that the Open/Short/Load is at the end of the test port or optional extension cable; that is, at the same point as the antenna or device to be tested will be connected.*

*For best results, use a phase stable Test Port Extension cable. In a typical laboratory cable, bending subsequent to the calibration will cause uncompensated phase reflections inside the cable. Cables that are not phase stable may cause measurement errors that become more pronounced as the test frequency increases.*

## SWR (Return Loss) and Cable Loss Measurement

The following frequency domain measurement is an example of a Standing Wave Ratio (or Return Loss) and Cable Loss measurement made over a selectable frequency range. This measurement example determines the quality and loss of the test port cable or device under test.

### Required Equipment

- Site Master Model SM5559
- Precision Open/Short, Anritsu 22N50 and Precision Load, Anritsu SM/PL *or* Precision Open/Short/Load, Anritsu OSLN50LF
- Test Port Extension Cable, Anritsu 15NNF50-1.5A

### Device-Under-Test Specification

Type	Typical Loss @1.5m	V <sub>g</sub>	Return Loss	SWR
15NNF50-1.5A	0.10 dB @30 MHz 0.25 dB @400 MHz 0.45 dB @800 MHz 0.60 dB @1590 MHz	0.86	≥ 21 dB	≤1.20

### Procedure

**Step 1.** Press the **ON/OFF** key on the Site Master.

### Selecting the Measurement Mode

**Step 2.** Press the **MODE** key.

**Step 3.** Use the Up/Down arrow key to scroll to **FREQ-SWR** or **FREQ-RETURN LOSS**.

**Step 4.** Press the **ENTER** key to select Frequency SWR or Return Loss measurement mode.

### Selecting the Frequency Range

**Step 5.** Press the **FREQ/DIST** key.

**Step 6.** Press the **F1** soft key.

**Step 7.** Enter 5 using the key pad or the Up/Down arrow key.

**Step 8.** Press **ENTER** to set F1 to 5 MHz.

**Step 9.** Press the **F2** soft key.

**Step 10.** Enter 1, 6, 0, 0 using the keypad or the Up/Down arrow key.

**Step 11.** Press **ENTER** to set F2 to 1600 MHz.

**Step 12.** Check that the FREQ (MHz) scale in the display area indicates the new frequency start and stop values (F1 = 5 MHz, F2 = 1600 MHz).

## Performing a Calibration

**Step 13.** Press the **START CAL** key. Follow the instructions that appear in the message area.

**Step 14.** Connect the Open, Short, and Load component to the test port and press the **ENTER** key as prompted after connecting each component.

Refer to the “Performing a Calibration” procedure on page 4-3 for detailed calibration steps.

**NOTES:**

*For best calibration results — compensation for all measurement system uncertainties — ensure that the Open/Short/Load is at the end of the test port or optional extension cable; that is, at the same point that you will connect the antenna or device to be tested.*

*For best results, use a phase stable Test Port Extension Cable (see Optional Accessories). If you use a typical laboratory cable to extend the Anritsu test port to the device-under-test, cable bending subsequent to the Open/Short/Load calibration will cause uncompensated phase reflections inside the cable. Thus, cables which are not phase stable may cause measurement errors that are more pronounced as the test frequency increases.*

*For optimum calibration, Anritsu recommends using precision calibration components.*

## SWR or Return Loss Measurement

**Step 15.** Disconnect the Load and connect the test port extension cable to the Site Master test port.

**Step 16.** Connect the Load to the open end of the test port extension cable as shown in Figure 4-4.

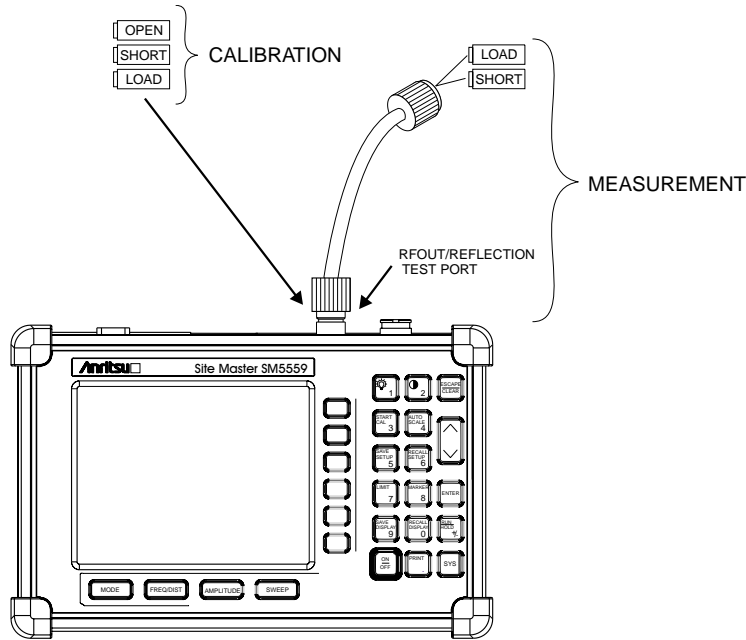

Figure 4-4. Cable Measurement Test Setup

**Step 17.** Observe the displayed measurement. Figures 4-5 and 4-6 show typical SWR and Return Loss measurements with markers and limit line set.

### Set the Amplitude Scale and Limit Line

The following procedure sets the top and bottom scale display.

**Step 18.** Press the **AMPLITUDE** or **LIMIT** key to call up the Scale Menu.

**Step 19.** In SWR mode, press the **TOP** soft key and enter 1, ., 3 using the keypad or Up/Down arrow key. Press **ENTER** to set the top scale. (In Return Loss mode, enter 0.)

**Step 20.** In SWR mode, press the **BOTTOM** soft key and enter 1 using the keypad or Up/Down arrow key. Press **ENTER** to set the bottom scale. (In Return Loss mode, enter 54.)

**Step 21.** Press the **LIMIT EDIT** soft key. For Freq-SWR, enter 1, ., 2. using the keypad or Up/Down arrow key. Press **ENTER** to set the limit line. For Freq-Return Loss, enter 21.

## Setting the Markers

**Step 22.** Press the **MARKER** key to call up the Markers menu.

**Step 23.** Press the **M1** soft key to select the M1 marker function. Press the **EDIT** soft key and enter 3, 0 using the keypad or Up/Down arrow key. Press **ENTER** to set M1 to 30 MHz. (Note: pressing the **ON/OFF** soft key activates or deactivates the M1 marker function.)

**Step 24.** Press the **BACK** soft key to return to the Markers menu.

**Step 25.** Repeat steps 22 and 23 for marker M2. Set M2 to 400 MHz, M3 to 800 MHz, and M4 to 1590 MHz (Figures 4-5 and 4-6 depict the SWR and Return Loss measurements).

**NOTE:**

Refer to page 4-4 for instructions on saving and recalling a setup or display.

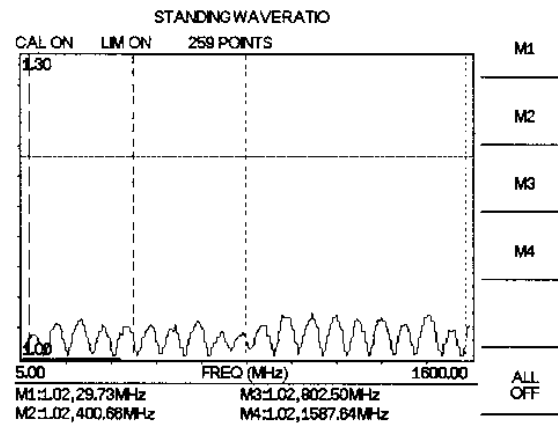

Figure 4-5. Cable SWR Measurement Results

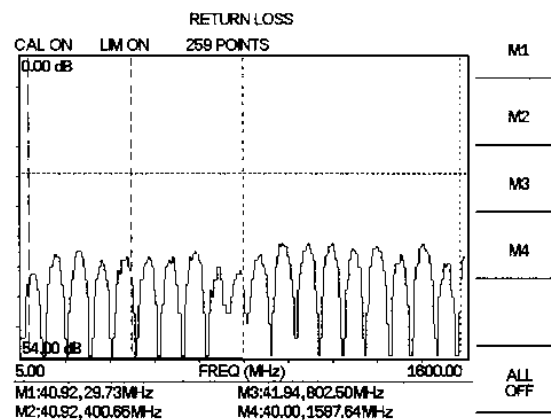

Figure 4-6. Cable Return Loss Measurement Results

## Cable Loss Measurement

The following frequency domain measurement is an example of a Cable Loss measurement made over a selectable frequency range using the one-port loss method. This method gives a quick and relatively accurate cable loss measurement without resorting to the two-port “thru” insertion loss method.

**NOTE:**

*If **CAL ON** is not displayed in the upper left of the Site Master display, or if the SWR/Return Loss measurement steps from earlier in this chapter were not completed, the Site Master must be calibrated before continuing.*

**Step 26.** Disconnect the load from the end of the cable and replace it with a short.

**Step 27.** Press the **MODE** key.

**Step 28.** Use the Up/Down arrow key to scroll to **CABLE LOSS - ONE PORT**.

**Step 29.** Press **ENTER** to select Cable Loss measurement mode.

## Setting the Amplitude Scale

The following procedure sets the scale display.

**Step 30.** Press the **AMPLITUDE** key to call up the Scale Menu.

**Step 31.** Press the TOP soft key and enter 0 using the keypad or Up/Down arrow key. Press **ENTER** to set the top scale.

**Step 32.** Press the **BOTTOM** soft key and enter 1 using the keypad or Up/Down arrow key. Press **ENTER** to set the bottom scale.

**NOTE:**

*An alternative method of setting the amplitude scale is to use the **AUTO SCALE** key.*

## Setting the Markers

The following procedure sets the markers. Skip this section if the SWR/Return Loss measurement steps from earlier in this chapter were completed.

**Step 33.** Press the **MARKER** key to call up the Markers menu.

**Step 34.** Press the **M1** soft key to select the M1 marker function. Press the **EDIT** soft key and enter 3, 0 using the keypad or Up/Down arrow key. Press **ENTER** to set M1 to 30 MHz. (Note: pressing the **ON/OFF** soft key activates or deactivates the M1 marker function.)

**Step 35.** Press the **BACK** soft key to return to the Markers menu.



**Step 36.** Repeat steps 34 and 35 for markers M2, M3 and M4. Set M2 to 400 MHz, M3 to 800 MHz and M4 to 1590 MHz (Figure 4-7 depicts a Cable Loss measurement).

**NOTE:**  
 Typical cable loss is the average between the peaks and valleys.

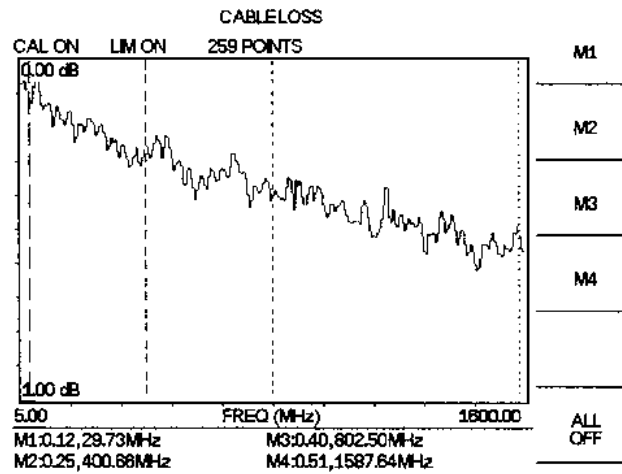

Figure 4-7. Cable Loss Measurement Results

**NOTE:**  
 Refer to page 4-4 for instructions on saving and recalling a setup or display.

## DTF Measurement

The following distance domain measurement is an example of a Distance-to-Fault (DTF) measurement over a selectable distance range.

### Required Equipment

- Site Master Model SM5559
- Precision Open/Short, Anritsu 22N50 and Precision Load, Anritsu SM/PL or Precision Open/Short/Load, Anritsu OSLN50LF
- Test Port Extension Cable, Anritsu 15NNF50-1.5A

### Device-Under-Test Specification

Type	Typical Loss @1.5m	V <sub>g</sub>	Return Loss	SWR
15NNF50-1.5A	0.10 dB @ 30 MHz 0.25 dB @ 400 MHz 0.45 dB @ 800 MHz 0.60 dB @ 1590 MHz	0.86	≥21 dB	≤1.20

### Procedure

**Step 1.** Press the **ON/OFF** key on the Site Master.

### Selecting the Measurement Mode

**Step 2.** Press the **MODE** key.

**Step 3.** Use the Up/Down arrow key to scroll to **DTF-SWR** or **DTF-RETURN LOSS**.

**Step 4.** Press the **ENTER** key to select DTF-SWR or Return Loss measurement mode. If the Site Master has not been calibrated (CAL OFF displayed in the upper left of the display), the DTF AID parameter table will appear.

*NOTE: Where CAL ON is indicated on the Site Master, pressing the DTF AID soft key will activate the DTF parameter table. However, distance and cable type (propagation velocity and loss) have not been optimized. F1 and F2 are set by "CAL ON" setup. DTF measurement is valid for  $D2 \leq D_{max}$  (as defined by F2 and F1).*

*The number of data points (resolution) will automatically adjust according to the length of D2.*

*English or metric units can be selected using the SYS key (page 3-9).*

**Step 5.** Use the Up/Down arrow key to scroll to **D2**, then press **ENTER** to select the cable length.

**Step 6.** Enter 2 using the keypad or the Up/Down arrow key. Press **ENTER** to set D2 to 2.0 meters.

**Step 7.** Use the Up/Down arrow key to scroll to **F1**, then press **ENTER** to select the start frequency F1.

**Step 8.** Enter 5 using the keypad or the Up/Down arrow key. Press **ENTER** to set F1 to 5 MHz.

- Step 9.** Use the Up/Down arrow key to scroll to **F2**, then press **ENTER** to select the start frequency F2.
- Step 10.** Enter 1, 6, 0, 0 using the keypad or the Up/Down arrow key. Press **ENTER** to set F2 to 1600 MHz.
- Step 11.** Scroll to **PROP VEL** and press **ENTER** to select Propagation Velocity.

**NOTE:**  
*Propagation velocity and cable loss can be accessed by selecting **CABLE FUNCTION** from DTF AID parameter table.*

- Step 12.** Enter ., 8, 6 and press **ENTER** to set the Propagation Velocity to 0.86.
- Step 13.** Press **ENTER** to start the calibration.

**NOTE:**  
*If the calibration is valid, scroll to **CONTINUE** and press **ENTER**. If calibration is necessary, proceed to the calibration instructions.*

## Performing a Calibration

This procedure is used to perform a calibration.

- Step 14.** At the Perform Calibration menu, follow the instructions on the display to connect the respective calibration components to the Site Master test port. (Refer to the calibration procedure on page 4-3.)

**NOTES:**  
*For best calibration results — compensation for all measurement system uncertainties — ensure that the Open/Short/Load is at the end of the test port or optional extension cable; that is, at the same point that you will connect the antenna or device to be tested.*

*For best results, use a phase stable Test Port Extension Cable (see Optional Accessories). If you use a typical laboratory cable to extend the Anritsu test port to the device-under-test, cable bending subsequent to the Open/Short/Load calibration will cause uncompensated phase reflections inside the cable. Thus, cables which are not phase stable may cause measurement errors that are more pronounced as the test frequency increases.*

*For optimum calibration, Anritsu recommends using precision calibration components.*

## DTF Measurement (Determining the Length of the Cable)

**Step 15.** Disconnect the Load (if applicable) and connect the test port extension cable to the Site Master test port.

**Step 16.** Connect the Short to the open end of the test port extension cable.

**NOTE:**

*The number of data points displayed can be changed by selecting **RES** in the DTF AID table.*

## Setting the Amplitude Scale

**Step 17.** Press the **AMPLITUDE** or **LIMIT** key to call up the Scale Menu.

*Optional:* Press the **AUTO SCALE** key to optimize the amplitude scale.

**Step 18.** In SWR mode, press the **TOP** soft key and enter 3, 0 using the keypad or Up/Down arrow key. Press **ENTER** to set the top scale. (In Return Loss mode, enter 0.)

**Step 19.** In SWR mode, press the **BOTTOM** soft key and enter 1 using the keypad or Up/Down arrow key. Press **ENTER** to set the bottom scale. (In Return Loss mode, enter 54.)

## Setting the Marker

**Step 20.** Press the **MARKER** key to call up the Markers menu. Press the **ALL OFF** soft key to ensure that all markers are deactivated.

**Step 21.** Press the **M1** soft key to select the M1 marker function. (Note: pressing the **ON/OFF** soft key activates or deactivates the M1 marker function.)

**Step 22.** Press the **MARKER TO PEAK** soft key to find the cable length.

**Step 23.** Press the **BACK** soft key or the **ESCAPE** key to return to the previous menu. Figures 4-8 and 4-9 show cable length displays in SWR and Return Loss modes.

**NOTE:**

*Refer to page 4-4 for instructions on saving and recalling a setup or display.*

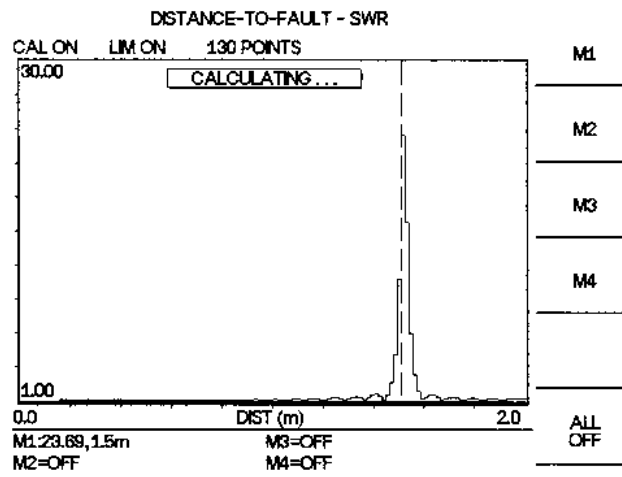

Figure 4-8. DTF - SWR Measurement Results (cable length)

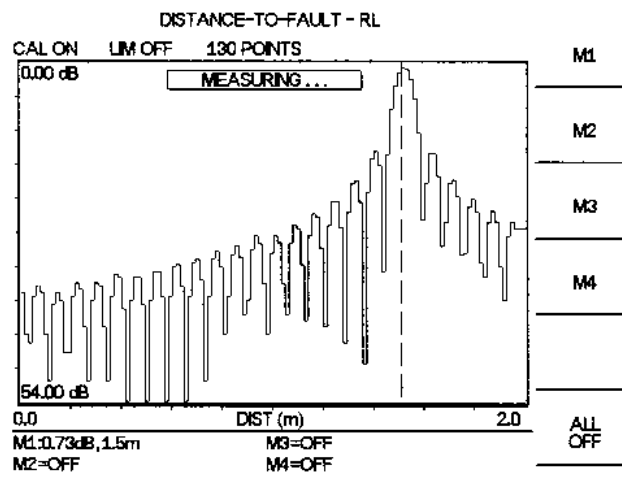

Figure 4-9. DTF - RETURN LOSS Measurement Results (cable length)

## DTF Measurement (Determining the quality of the cable.)

**NOTE:**

*If cable length measurement has not been done, calibration must be done before determining the quality of the cable (steps 1-15).*

**Step 24.** Disconnect the Short and connect the Load to the test port extension cable

### Setting the Amplitude Scale

**Step 25.** Press the **AMPLITUDE** or **LIMIT** key to call up the Scale Menu..

*Optional:* Press the **AUTO SCALE** key to optimize the amplitude scale.

**Step 26.** In SWR mode, press the **TOP** soft key and enter 1, ., 0, 5 using the keypad or Up/Down arrow key. Press **ENTER** to set the top scale. (In Return Loss mode, enter 20.)

**Step 27.** In SWR mode, press the **BOTTOM** soft key and enter 1 using the keypad or Up/Down arrow key. Press **ENTER** to set the bottom scale. (In Return Loss mode, enter 54.)

### Setting the Markers

**Step 28.** Press the **MARKER** key to call up the Markers menu.

**Step 29.** Press the **M2** soft key to select the M2 marker function. (Note: pressing the **ON/OFF** soft key activates or deactivates the M2 marker function.)

**Step 30.** Press the **MARKER TO PEAK** soft key to find the maximum SWR or Return Loss reading. (See Figures 4-10 and 4-11.)

**NOTE:**

*Refer to page 4-4 for instructions on saving and recalling a setup or display.*

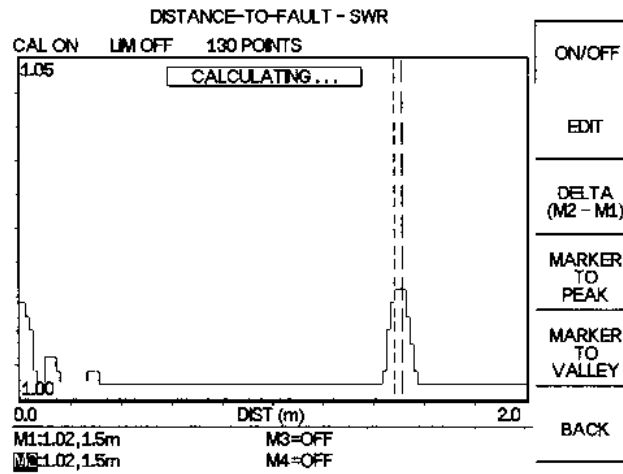

Figure 4-10. DTF - SWR Measurement Results (cable quality)

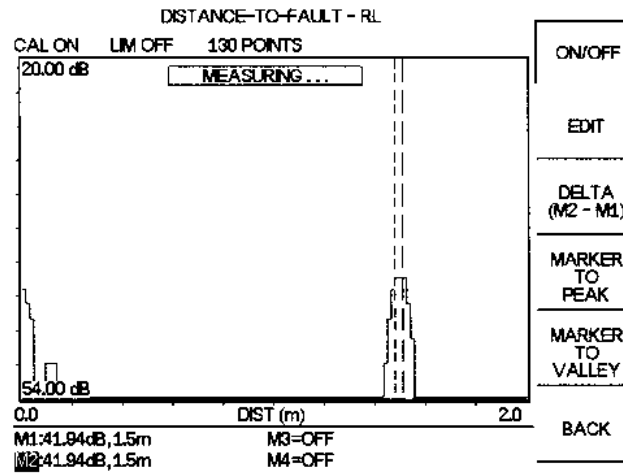

Figure 4-11. DTF - RETURN LOSS Measurement Results (cable quality)

## Making Power Measurements

Power measurement is accomplished using a broadband (1 MHz to 3000 MHz) RF detector, P/N 5400-71N50. The power monitor displays measured power in dBm or Watts.

### Entering Power Monitor Mode

- Step 1.** Press the **MODE** key.
- Step 2.** Use the Up/Down arrow key to scroll to **POWER MONITOR**. Press **ENTER** to select power monitor mode.

### Zeroing the Power Monitor

- Step 3.** With no power applied to the DUT, press the **ZERO** soft key from the Power menu. Wait a few seconds while the Site Master accumulates samples of the quiescent power level. When complete, **ZERO ADJ: ON** is displayed in the message area.

### Measuring High Input Power Levels

- Step 4.** Insert an attenuator between the DUT and the RF detector, sufficient to insure that the input power to the Site Master is no greater than 20 dBm.
- Step 5.** Press the **OFFSET** soft key.
- Step 6.** Enter the attenuation in dB using the keypad. Press **ENTER** to complete the entry. The message area will show **OFFSET is ON** along with the entered value in dB.

### Displaying Power in dBm and Watts

- Step 7.** Press the **UNITS** soft key to display power in Watts.

### Displaying Relative Power

- Step 8.** With the desired base power level input to the Site Master, press the **REL** soft key. The message area will show **REL: ON** and the power reading will indicate 100%.
- Step 9.** Press the **UNITS** soft key to display power in dBm. Since REL is ON, the power reading will be in dB<sub>r</sub>, relative to the base power level.



# Chapter 5

## Software Tools

### Program

## Description

The Site Master Software Tools program provides the means for transferring the measured trace, along with any applied markers and/or a limit, to the screen of an MS-DOS based personal computer (PC) running Windows 95/98/NT.

## Requirements

The Site Master Software Tools program is a standard Windows program and will run on any computer that will run Windows 95/98/NT. Typically, this means having a PC with the following characteristics:

- Pentium microprocessor (100 MHz or better, recommended)
- Microsoft Windows 95/98/NT
- 32 MBytes of memory, minimum
- Approximately 15 MBytes of available hard drive space

## Communication Port Setting

The Site Master Software Tools communicates with the Site Master through a standard COM port on the PC. It is important that your Windows COM port settings conform to the actual hardware settings. Since various add-in devices such as sound cards, modems, and network cards use IRQ (Interrupts), it is possible that your computer has non-standard COM port settings. Please consult your computer vendor for COM port address and IRQ information.

### Changing COM Port Settings—Windows 95/98/NT

- Step 1.** Open the Windows Control Panel.
- Step 2.** Double click on the **SYSTEM** icon. The System Properties window appears.
- Step 3.** Select **Device Manager**. The Device List appears.
- Step 4.** Double click on the item Ports (COM & LPT) in the device list.
- Step 5.** Double click on the communications port you want to set. The Communications Port Properties window appears.

**NOTE:**  
*If Windows doesn't show any available COM Ports, consult your computer manufacturer.*

- Step 6.** Choose Port Settings, then change to the following settings as necessary.
- Baud Rate: 9600 (selectable up to 56k)
  - Data Bits: 8
  - Parity: None
  - Stop Bits: 1
  - Flow Control: None
- Step 7.** Choose **Resource** and verify the COM Port Base Address and IRQ. Click **OK** when done.
- Step 8.** Click **OK** again to close the System Properties window.

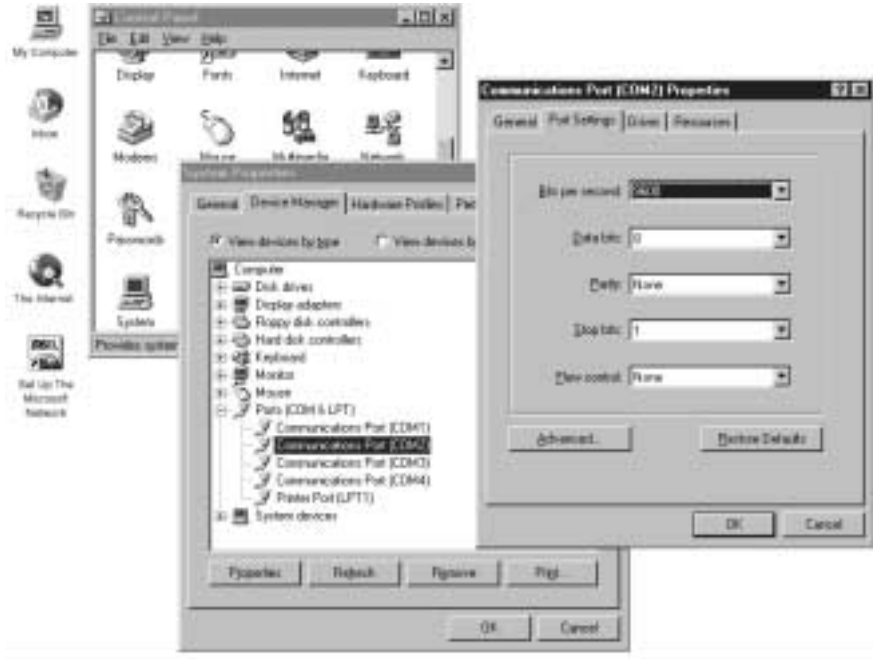

Figure 5-1. Windows 95/98/NT COM Port Setting Dialog Boxes

**Note:**  
If you changed the COM Port Base Address and/or IRQ, you will need to restart Windows.

## Software Installation

The Site Master Software Tools program is a conventional Microsoft Windows program. Installation is similar to all other such programs. For users new to Windows, a detailed procedure is given below.

- Step 9.** Insert the Anritsu Site Master Software Tools For Windows disk in the CDROM drive.
- Step 10.** Select **Run** under the Start menu.
- Step 11.** Type **x:\SETUP**, where x = the drive letter of the CDROM drive.
- Step 12.** Press the **Enter** key to select the default directory **C:\Program Files\Site Master Software Tools\** and begin the Setup routine.
- Step 13.** When the Setup program prompts, select **OK** or press the **Enter** key to restart Windows.

*NOTE: The Setup routine will create a new Program Group named "Site Master Software Tools". This group will contain three file icons, "Read Me," "Site Master Help," and "Site Master Software Tools."*

- Step 14.** Double-click on the "Read Me" icon to read about recent changes that did not get into this manual and important features or problems that you should know about.
- Step 15.** Double-click on the "Site Master Help" icon to acquaint yourself with the comprehensive on-line manual. This manual provides descriptive narrative for the various program features and controls.
- Step 16.** Double-click on the "Site Master Software Tools" icon to open the Software Tools program.
- Step 17.** Click on **Settings**, in the top menu bar, and select **COM Port**. Enter the appropriate COM port number for the serial interface cable (null modem type).

## Plot Capture

Plots (traces) can be captured either singly from the Site Master display or in multiples from one or more stored-display locations. Both methods are described below.

The recommended method is to capture multiple traces to a database. In one operation, all of the data residing in the up-to-200 stored display memory locations in the Site Master can be downloaded to a database for easy data management.

*NOTE: Trace scale can be captured as per Site Master or as autoscale by the capture program. To select per Site Master or autoscaling, click on Settings and Default Plot Settings from the top menu bar and pull-down menu.*

## Capture multiple traces to a database

**Step 1.** Connect the supplied cable as shown in Figure 5-2.

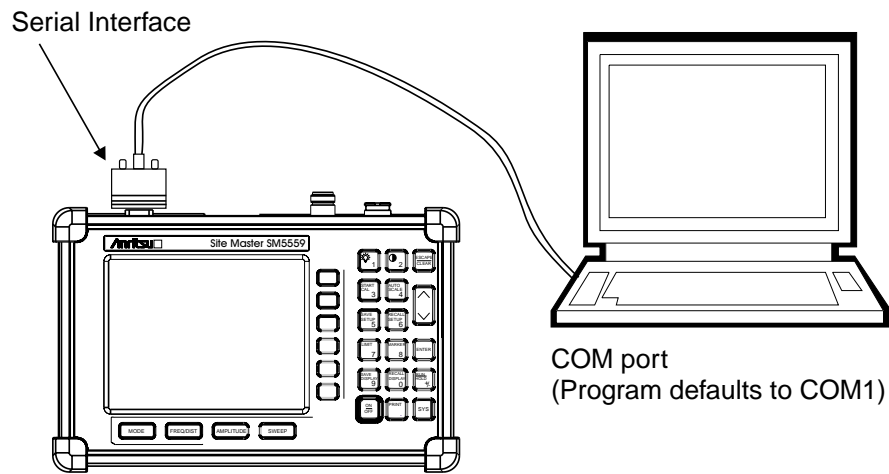

Figure 5-2. Serial Cable Connection

- Step 2.** Open the Site Master Software Tools program.
- Step 3.** Double-click on the “Site Master Software Tools” icon to open the program.
- Step 4.** Click on **Capture**, in the top menu bar, and select **Capture Plots To Database** from the drop-down menu.
- Step 5.** Follow the database instructions to download the plot(s) to either a new database or an existing database.
- Step 6.** Click on an individual plot icon, or on a folder icon to select all plots within that folder, to select the plot(s) to be stored in the database. Click **OK**.
- Step 7.** Observe that the “Acquiring Control” box appears on the screen, then disappears as traces are automatically acquired. The “Database” box appears when the plot(s) has been completely captured into the database.

## Capture single or multiple traces to PC screen

- Step 1.** Perform steps 1, 2, and 3 of the capture-multiple-traces-to-database procedure.
- Step 2.** Click on the **Start Plot Capture** icon or click on **Capture**, in the top menu bar, and select **Capture Plots to Screen** from the drop-down menu.
- Step 3.** Click on an individual plot icon, or on a folder icon to select all plots within that folder, to select the plot(s) to be stored in the database.
- Step 4.** Select **OK**.
- Step 5.** Observe that the “Acquiring Control” box appears on the screen, then disappears as the traces are automatically acquired and displayed.

## Custom Cable List Uploading and Downloading

Custom cable parameters can be uploaded to the Site Master or downloaded from the Site Master and saved via the Site Master Software Tools Cable Editor.

### Uploading a Cable List to the Site Master Custom Cable Table

- Step 1.** Connect the supplied cable as shown in Figure 5-2.
- Step 2.** Open the Cable Editor by clicking on **Start, Programs, Site Master Software Tools 32 bit** and **Cable Editor**.

Alternatively, open the Site Master Software Tools program, click on **Tools** in the top menu bar and select **Cable Editor** from the drop-down menu.

- Step 3.** Enter the required information for each custom cable entry:
  - Cable Name** - enter the cable description
  - Pro. Vel** - enter the propagation velocity value
  - Insertion Loss (dB/m)** - enter the insertion loss value in dB/m
  - Frequency (MHz)** - enter the frequency in MHz
  - Description** - enter any description associated with that custom cable.

**NOTES:**

*As a minimum, the Cable Name and Pro. Vel cells must have entries for the Site Master to accept the selection as a valid cable during uploading. The Site Master will assign a zero value to insertion loss if the Insertion Loss cell has no entry.*

*Information entered into the Frequency and Description cells is not uploaded to the Site Master and so those cells will have no information when downloading the custom cable list from the Site Master back to the Cable Editor.*

- Step 4.** Click on the **Upload Cable List** icon or click on **Tools**, in the top menu bar, and select **Upload Cable List**.
- Step 5.** When the message box appears on the screen click **OK** to the cable upload warning and **OK** when the cable upload is completed.

### Downloading a Cable List from the Site Master Custom Cable Table

- Step 1.** Perform steps 1 and 2 above to open the Cable Editor.
- Step 2.** Click on the **Query Cable List** icon, or click on **Tools** in the top menu bar and select **Query Cable List**.
- Step 3.** When the status message box appears on the screen, click **OK** to complete.

### Saving a Custom Cable List

To save a custom cable to a file, click on **File**, in the top menu bar and select **Save** or **Save as** from the drop-down menu.

## Program Operation

The captured trace on the PC can be scaled and have its limit line, markers, and properties changed. (Click on the **Plot Properties** icon, or select **Plot Properties** under the **View** menu to make these changes.) The operation of the various menus that allow these operations to be accomplished is straightforward. To read about the operation of the menus, refer to the on-line help screens, accessed from the **Help** menu in the top menu bar.

## Fault Location Software

A captured RL or SWR trace can be transformed to a Distance to Fault display. This is useful for determining the location of faults, connections, and other discontinuities within the cable.

To transform a plot, select Distance to Fault from the **Tools** menu (or click on the Distance to Fault icon in the toolbar). A drop down menu will appear that asks you if the DUT is coaxial cable or waveguide.

If coaxial cable is selected, it asks you to supply start and stop distances along with the cable type or propagation velocity and insertion loss values. Tables in Appendix A provide these values for some of the more popular coaxial cables (@ 1000 MHz).

If values are needed at a different frequency, or if you need the exact values for more accurate measurement, please contact the coaxial cable manufacturer. Coaxial cables may be added to the list by editing the `cables.lst` file. Follow the existing format to enter the data to the list. Loss is entered in dB/m only.

The distance may be entered in feet or meters. Propagation velocity is used for coaxial cable. The units may be changed by selecting **Default Plot Settings** under the **Settings** menu and changing Measurement Units.

After supplying the needed information and clicking **OK**, a new plot will open showing coax match vs. distance.



## Smith Chart Software

After obtaining a frequency SWR or RL plot on the computer display, click the **Smith Chart** icon. Read the Help file to see how this feature functions (under Smith Chart and Data Readout).

## Saving a Plot as a Windows Metafile or as a Spreadsheet File

Plots can be saved as Windows metafile (.wmf) or as a text file (.txt). The metafile may be imported into graphic programs and a text file can be imported into a spreadsheet program, but they cannot be reloaded into the Site Master Software Tools program.

To save a plot as a Windows Metafile, click on File, in the top menu bar, and select **Export to Windows Metafile** from the drop down menu.

To save a plot as a text file to use in a spreadsheet, click on File in the top menu bar and select **Export to text file for Spreadsheet** from the drop down menu.

## Pasting a Plot in Graphic or Spreadsheet Format

The data points from a plot can be exported to a graphic application or a spreadsheet via the clipboard. To transfer data to the Windows clipboard:

- Step 1.** Select Settings and **Clipboard Format** from the top menu bar and pull-down menu and choose either **graphical** or **tabular** format.
- Step 2.** Capture or load the desired plot.
- Step 3.** Copy the data to the clipboard by selecting the **Copy Plot Data** icon or **Copy** from the Edit menu.
- Step 4.** To paste to a graphic application, open the application and select Paste from the application's **Edit** menu.
- Step 5.** To paste to a spreadsheet, open the spreadsheet program and place the cursor where the first data point should appear.
- Step 6.** Select Paste from the spreadsheet program's **Edit** menu.

## Saving Data to a Database

Plots can be saved to a database. Comments can be added to the plot data saved. Queries of the database provide a means of comparing plots in the database. Refer to the on-line help screens for operating instructions.

To save a plot to a database, click on **File**, in the top menu bar, and select **Save Plot to Database** from the drop-down menu. Follow the database instructions to download the plot to a new or existing database.

## Mouse Function

The mouse function icon toggles the mouse action from “drag-n-drop” (plot overlay) to “click-n-drag” (marker/limit zoom) and back.

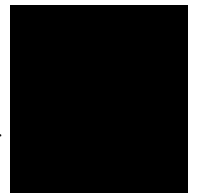

## “Drag-n-Drop”

Site Master Software Tools is Windows based. Graphs can “Drag-n-Drop” onto each other. Site Master Software Tools allows quick comparison of “before” and “after” Distance-To-Fault measurements. Recent data is compared to a historical PC database record, which is usually recorded during site installation/commissioning.

Each cable/antenna tends to have a unique Distance-To-Fault (DTF) “Signature” because differing cable electrical lengths, cable types, dielectric thickness variations, and the positions of components (connectors, adapters, and lightning arresters) will cause different reflections at differing positions in the transmission line. Variations in the “signature” between maintenance intervals offer a good indication of damage or damage causing conditions.

## “Click-n-Drag”

Markers and Limit lines can be moved to a new value using the mouse. Simply click on the marker or limit line and drag it to the new value location.

Click and drag within the plot to zoom in on a selected area. To zoom out, click on the “Undo Zoom” icon.

## Printing

Captured traces may be printed from a PC using Site Master Software Tools. Once a captured trace has been downloaded choose **Print** under the **File** menu for printing options. The printer setup can be altered, plots can be scaled, and multiple plots can be printed from the Print dialog box.

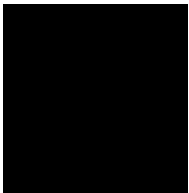



# Appendix A

## Reference Data

### Coaxial Cable Technical Data

Table A-1 provides a standard listing of common coaxial cables along with their “Relative Propagation Velocity” and “Nominal Attenuation in dB/m @ 1000 MHz” values.

Table A-1. Coaxial Cable Technical Data (1 of 2)

Cable Type	Relative Propagation Velocity ( $V_f$ )	Nominal Attenuation dB/m @ 1000 MHz
RG8, 8A	0.659	0.262
RG9, 9A	0.659	0.289
RG17, 17A	0.659	0.180
RG55, 55A, 55B	0.659	0.541
RG58, 58B	0.659	0.558
RG58A, 58C	0.659	0.787
RG142	0.690	0.443
RG174	0.660	0.984
RG178B	0.690	1.509
RG188	0.690	1.017
RG213	0.660	0.292
RG214	0.659	0.292
RG223	0.659	0.535
FSJ1-50A	0.840	0.197
FSJ2-50	0.830	0.134
FSJ4-50B	0.810	0.119
LDF4-50A	0.880	0.077
LDF5-50A	0.890	0.043
LDF6-50	0.890	0.032
LDF7-50A	0.880	0.027
LDF12-50	0.880	0.022
HJ4-50	0.914	0.087
HJ4.5-50	0.920	0.054
HJ5-50	0.916	0.042
HJ7-50A	0.921	0.023
LMR100	0.800	0.792
LMR200	0.830	0.344
LMR240	0.840	0.262
LMR400	0.850	0.135
LMR500	0.860	0.109

**Appendix A Reference Data**

---

Table A-1. Coaxial Cable Technical Data (2 of 2)

<b>Cable Type</b>	<b>Relative Propagation Velocity (<math>V_f</math>)</b>	<b>Nominal Attenuation dB/m @ 1000 MHz</b>
LMR600	0.870	0.087
LMR900	0.870	0.056
LMR1200	0.880	0.044
LMR1700	0.890	0.033
HCC12-50J	0.915	0.042
HCC78-50J	0.915	0.042
HCC158-50J	0.950	0.023
HCC300-50J	0.960	0.014
HCC312-50J	0.960	0.013
HF 4-1/8" Cu2Y	0.970	0.010
HF 5" Cu2Y	0.960	0.007
HF 6-1/8" Cu2Y	0.970	0.006
FLC 38-50J	0.880	0.115
FLC 12-50J	0.880	0.075
FLC 78-50J	0.880	0.045
FLC 114-50J	0.880	0.034
FLC 158-50J	0.880	0.029
CR50 540PE	0.880	0.070
CR50 1070PE	0.880	0.038
310801	0.820	0.115
311201	0.800	0.180
311501	0.800	0.230
311601	0.800	0.262
311901	0.800	0.377
352001	0.800	0.377



**Anritsu**